

HDL Verifier™

User's Guide

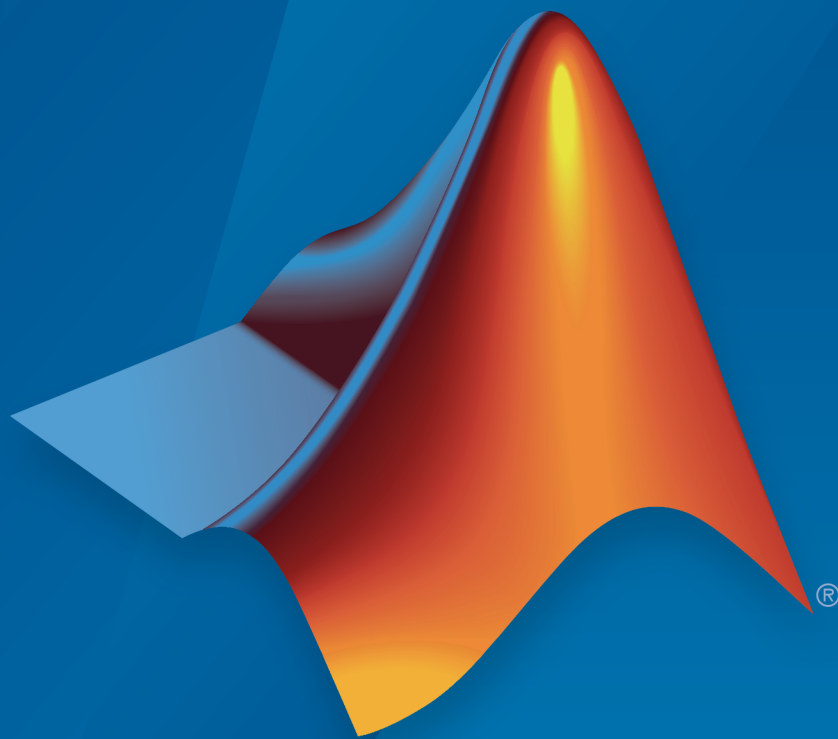

MATLAB® & SIMULINK®

R2016a



How to Contact MathWorks



Latest news: www.mathworks.com
Sales and services: www.mathworks.com/sales_and_services
User community: www.mathworks.com/matlabcentral
Technical support: www.mathworks.com/support/contact_us



Phone: 508-647-7000



The MathWorks, Inc.
3 Apple Hill Drive
Natick, MA 01760-2098

HDL Verifier™ User's Guide

© COPYRIGHT 2003–2016 by The MathWorks, Inc.

The software described in this document is furnished under a license agreement. The software may be used or copied only under the terms of the license agreement. No part of this manual may be photocopied or reproduced in any form without prior written consent from The MathWorks, Inc.

FEDERAL ACQUISITION: This provision applies to all acquisitions of the Program and Documentation by, for, or through the federal government of the United States. By accepting delivery of the Program or Documentation, the government hereby agrees that this software or documentation qualifies as commercial computer software or commercial computer software documentation as such terms are used or defined in FAR 12.212, DFARS Part 227.72, and DFARS 252.227-7014. Accordingly, the terms and conditions of this Agreement and only those rights specified in this Agreement, shall pertain to and govern the use, modification, reproduction, release, performance, display, and disclosure of the Program and Documentation by the federal government (or other entity acquiring for or through the federal government) and shall supersede any conflicting contractual terms or conditions. If this License fails to meet the government's needs or is inconsistent in any respect with federal procurement law, the government agrees to return the Program and Documentation, unused, to The MathWorks, Inc.

Trademarks

Screenshots of ModelSim in the HDL Verifier™ documentation are copyright protected by Mentor Graphics Corporation.

MATLAB and Simulink are registered trademarks of The MathWorks, Inc. See www.mathworks.com/trademarks for a list of additional trademarks. Other product or brand names may be trademarks or registered trademarks of their respective holders.

Patents

MathWorks products are protected by one or more U.S. patents. Please see www.mathworks.com/patents for more information.

Revision History

August 2003	Online only	New for Version 1 (Release 13SP1)
February 2004	Online only	Revised for Version 1.1 (Release 13SP1)
June 2004	Online only	Revised for Version 1.1.1 (Release 14)
October 2004	Online only	Revised for Version 1.2 (Release 14SP1)
December 2004	Online only	Revised for Version 1.3 (Release 14SP1+)
March 2005	Online only	Revised for Version 1.3.1 (Release 14SP2)
September 2005	Online only	Revised for Version 1.4 (Release 14SP3)
March 2006	Online only	Revised for Version 2.0 (Release 2006a)
September 2006	Online only	Revised for Version 2.1 (Release 2006b)
March 2007	Online only	Revised for Version 2.2 (Release 2007a)
September 2007	Online only	Revised for Version 2.3 (Release 2007b)
March 2008	Online only	Revised for Version 2.4 (Release 2008a)
October 2008	Online only	Revised for Version 2.5 (Release 2008b)
March 2009	Online only	Revised for Version 2.6 (Release 2009a)
September 2009	Online only	Revised for Version 3.0 (Release 2009b)
March 2010	Online only	Revised for Version 3.1 (Release 2010a)
September 2010	Online only	Revised for Version 3.2 (Release 2010b)
April 2011	Online only	Revised for Version 3.3 (Release 2011a)
September 2011	Online only	Revised for Version 3.4 (Release 2011b)
March 2012	Online only	Revised for Version 4.0 (Release 2012a)
September 2012	Online only	Revised for Version 4.1 (Release 2012b)
March 2013	Online only	Revised for Version 4.2 (Release 2013a)
September 2013	Online only	Revised for Version 4.3 (Release 2013b)
March 2014	Online only	Revised for Version 4.4 (Release 2014a)
October 2014	Online only	Revised for Version 4.5 (Release 2014b)
September 2015	Online only	Revised for Version 4.7 (Release 2015b)
March 2016	Online only	Revised for Version 5.0 (Release 2016a)

HDL Verification with Cosimulation

HDL Cosimulation Using MATLAB Test Bench Function

1

MATLAB as a Test Bench	1-2
Create a MATLAB Test Bench	1-4
Code HDL Modules for Verification Using MATLAB . . .	1-5
Overview to Coding HDL Modules for Verification with MATLAB	1-5
Choose HDL Module Name for Use with MATLAB Test Bench	1-5
Specify Port Direction Modes in HDL Module for Use with Test Bench	1-6
Specify Port Data Types in HDL Modules for Use with Test Bench	1-6
Compile and Elaborate HDL Design for Use with Test Bench	1-7
Sample VHDL Entity Definition	1-9
Code an HDL Verifier Test Bench Function	1-10
Process for Coding MATLAB HDL Verifier Functions .	1-10
Syntax of a Test Bench Function	1-11
Sample MATLAB Test Bench Function	1-11
Place Test Bench on MATLAB Search Path	1-18
Use MATLAB which Function to Find Test Bench	1-18
Add Test Bench Function to MATLAB Search Path . . .	1-18

Start Server for MATLAB—HDL Simulator	
Connection	1-19
Start MATLAB Server for Test Bench Session	1-19
Example of Starting MATLAB Server for Test Bench Session	1-20
Start HDL Simulator	1-21
Start the HDL Simulator for Test Bench Session	1-21
Load an HDL Design for Verification	1-21
Bind Test Bench Function Calls With <code>matlabtb</code>	1-22
Invoke MATLAB Test Bench Command <code>matlabtb</code>	1-22
Bind HDL Module Component to MATLAB Test Bench Function	1-24
Schedule Options for a Test Bench Session	1-26
About Scheduling Options for Test Bench Sessions	1-26
Schedule Test Bench Session Using <code>matlabtb</code> Arguments	1-26
Schedule Test Bench Functions With the <code>tnext</code> Parameter	1-27
Run MATLAB Test Bench Simulation	1-29
Process for Running MATLAB Test Bench Cosimulation	1-29
Check MATLAB Server's Link Status for Test Bench Cosimulation	1-29
Run Test Bench Cosimulation	1-30
Apply Stimuli to Test Bench Session with <code>force</code> Command	1-33
Restart Test Bench Simulation	1-35
Stop Test Bench Simulation	1-36
Verify HDL Model with MATLAB Test Bench	1-37
Tutorial Overview	1-37
Set Up Tutorial Files	1-38
Start the MATLAB Server	1-38
Start ModelSim Simulator and Set Up for Cosimulation	1-40
Develop VHDL Code	1-41
Compile VHDL	1-43
Develop MATLAB Function	1-44
Load Simulation	1-46

Run Simulation	1-48
Shut Down Simulation	1-52
Automatic Cosimulation Verification	1-54

HDL Cosimulation Using MATLAB Component Function

2

MATLAB Function as a Component	2-2
Create a MATLAB Component Function	2-4
Code HDL Modules for Visualization Using MATLAB	2-5
Overview to Coding HDL Modules for Visualization with MATLAB	2-5
Choose HDL Module Name for Use with MATLAB Component Function	2-5
Specify Port Direction Modes in HDL Module for Use with Component Functions	2-6
Specify Port Data Types in HDL Modules for Use with Component Functions	2-6
Compile and Elaborate HDL Design for Use with Component Functions	2-8
Create an HDL Verifier MATLAB Component Function	2-10
Overview to Coding an HDL Verifier Component Function	2-10
Syntax of a Component Function	2-10
Place Component Function on MATLAB Search Path	2-12
Use MATLAB which Function to Find Component Function	2-12
Add Component Function to MATLAB Search Path	2-12
Start Connection to HDL Simulator	2-13
Start MATLAB Server for Component Function Session	2-13
Example of Starting MATLAB Server for Component Function Session	2-14

Start HDL Simulator	2-15
Start HDL Simulator for Component Session	2-15
Load HDL Design for Visualization	2-15
Bind Component Function Calls With matlabcp	2-16
Invoke MATLAB Component Function Command matlabcp	2-16
Bind HDL Module Component to MATLAB Component Function	2-18
Schedule Options for a Component Session	2-20
About Scheduling Options for Component Sessions ...	2-20
Schedule Component Session Using matlabcp Arguments	2-20
Schedule Component Functions Using the tnext Parameter	2-21
Run MATLAB Component Function Simulation	2-23
Process for Running MATLAB Component Function Cosimulation	2-23
Check MATLAB Server's Link Status for Component Cosimulation	2-23
Run Component Function Cosimulation	2-24
Apply Stimuli to Component Function with force Command	2-27
Restart Component Simulation	2-28
Stop Component Simulation	2-30

HDL Cosimulation Using MATLAB System Object

3

Create a MATLAB System Object	3-2
Verify Viterbi Decoder Using MATLAB System Object and Mentor Graphics ModelSim	3-3

Simulink as a Test Bench	4-2
Communications During Test Bench Cosimulation	4-2
HDL Cosimulation Block Features for Test Bench Simulation	4-5
Simulink Test Bench Cosimulation	4-7
Create Simulink Model for Test Bench Cosimulation ..	4-8
Create Simulink Model	4-8
Run Test Bench Hardware Model in Simulink	4-8
Add Value Change Dump (VCD) File (Optional)	4-8
Code an HDL Component	4-9
Overview to Coding HDL Components for Simulink Test Bench Sessions	4-9
Specify Port Direction Modes in the HDL Component for Test Bench Use	4-9
Specify Port Data Types in the HDL Component for Test Bench Use	4-9
Compile and Elaborate HDL Design for Test Bench Use	4-11
Start HDL Simulator	4-12
Start HDL Simulator from MATLAB	4-12
Load Instance of HDL Module for Test Bench Cosimulation	4-12
Add HDL Cosimulation Block to Model	4-14
Insert HDL Cosimulation Block	4-14
Connect Block Ports	4-15
Define HDL Cosimulation Block Interface	4-16
Open HDL Cosimulation Block Interface	4-16
Map HDL Signals to Block Ports	4-17
Specify Signal Data Types	4-32
Configure Simulink and HDL Simulator Timing Relationship	4-32
Configure Communication Link in the HDL Cosimulation Block	4-35

Specify Pre- and Post-Simulation Tcl Commands with HDL Cosimulation Block Parameters Dialog Box . . .	4-37
Programmatically Control Block Parameters	4-40
Run a Test Bench Cosimulation Session	4-42
Set Simulink Model Configuration Parameters	4-42
Determine Available Socket Port Number	4-43
Check Connection Status	4-43
Run and Test Test Bench Cosimulation Model	4-43
Avoid Race Conditions in HDL Simulation with Test Bench Cosimulation and the HDL Verifier HDL Cosimulation Block	4-46
Verify HDL Model with Simulink Test Bench	4-47
Tutorial Overview	4-47
Develop VHDL Code	4-47
Compile VHDL	4-49
Create Simulink Model	4-50
Set Up ModelSim for Use with Simulink	4-59
Load Instances of VHDL Entity for Cosimulation with Simulink	4-60
Run Simulation	4-61
Shut Down Simulation	4-64
Test Bench Automatic Verification with Simulink	4-65

Replace HDL Component with Simulink Algorithm

5

Component Simulation with Simulink	5-2
How the HDL Simulator and Simulink Software Communicate Using HDL Verifier For Component Simulation	5-2
HDL Cosimulation Block Features for Component Simulation	5-4
Replace HDL Component with Simulink Algorithm	5-6

Code an HDL Component	5-7
Overview to Coding HDL Modules for Simulink	
Component Simulation	5-7
Specify Port Direction Modes in HDL Module for	
Component Simulation	5-7
Specify Port Data Types in HDL Module for Component	
Simulation	5-7
Compile and Elaborate HDL Design for Component	
Simulation	5-9
Create Simulink Model for Component Cosimulation .	5-10
Simulink Model for Component Cosimulation	5-10
Run and Test Component Hardware Model in Simulink	5-10
Add Value Change Dump (VCD) File to Component Model	
(Optional)	5-10
Start HDL Simulator	5-11
Start HDL Simulator from MATLAB	5-11
Load Instance of HDL Module for Component	
Cosimulation	5-11
Add HDL Cosimulation Block to Model	5-13
Insert HDL Cosimulation Block	5-13
Connect Block Ports	5-14
Define HDL Cosimulation Block Interface	5-15
Open HDL Cosimulation Block Interface	5-15
Map HDL Signals to Block Ports	5-16
Specify Signal Data Types	5-31
Configure Simulink and HDL Simulator Timing	
Relationship	5-31
Configure Communication Link in the HDL Cosimulation	
Block	5-34
Specify Pre- and Post-Simulation Tcl Commands with	
HDL Cosimulation Block Parameters Dialog Box ..	5-36
Programmatically Control Block Parameters	5-39
Run a Component Cosimulation Session	5-41
Simulink Software Configuration Parameters	5-41
Determine Available Socket Port Number	5-42
Check Connection Status	5-42
Run and Test Component Cosimulation Model	5-42

Avoid Race Conditions in HDL Simulation with Component Cosimulation and the HDL Verifier HDL Cosimulation Block	5-45
---	------

Record Simulink Signal State Transitions for Post-Processing

6

Add a Value Change Dump (VCD) File	6-2
Introduction to the To VCD File Block	6-2
Using the To VCD File Block	6-3
Visually Compare Simulink Signals with HDL Signals .	6-6
Tutorial: Overview	6-6
Tutorial: Instructions	6-6

HDL Code Import for Cosimulation

7

Import HDL Code for Cosimulation	7-2
HDL Code Import Features	7-2
HDL Code Import Workflows	7-3
Cosimulation Wizard Navigation	7-3
Cosimulation Wizard Limitations	7-4
Invoke the Cosimulation Wizard	7-5
Import HDL Code for MATLAB Function	7-6
Cosimulation Type—MATLAB Function	7-6
HDL Files—MATLAB Function	7-8
HDL Compilation—MATLAB Function	7-9
HDL Modules—MATLAB Function	7-10
Callback Schedule—MATLAB Function	7-12
Script Generation—MATLAB Function	7-14
Complete the Component or Test Bench Function	7-15

Import HDL Code for MATLAB System Object	7-17
Cosimulation Type—MATLAB System Object	7-17
HDL Files—MATLAB System Object	7-20
HDL Compilation—MATLAB System Object	7-21
Simulation Options—MATLAB System Object	7-23
Input/Output Ports—MATLAB System Objects	7-24
Output Port Details—MATLAB System Object	7-25
Clock/Reset Details—MATLAB System Object	7-26
Start Time Alignment—MATLAB System Object	7-28
System Object Generation	7-29
Write System Object Test Bench	7-30
Run Cosimulation and Verify HDL Design	7-32
Import HDL Code for HDL Cosimulation Block	7-33
Cosimulation Type—Simulink Block	7-33
HDL Files—Simulink Block	7-35
HDL Compilation—Simulink Block	7-37
Simulation Options—Simulink Block	7-38
Input/Output Ports—Simulink Block	7-40
Output Port Details—Simulink Block	7-41
Clock/Reset Details—Simulink Block	7-43
Start Time Alignment—Simulink Block	7-44
Generate Block	7-46
Complete Simulink Model	7-47
Performing Cosimulation	7-48
Cosimulation Wizard for MATLAB System Object	7-50
Verify Raised Cosine Filter Design Using MATLAB	7-69
MATLAB and Cosimulation Wizard Tutorial Overview	7-69
Tutorial: Set Up Tutorial Files (MATLAB)	7-70
Tutorial: Launch Cosimulation Wizard (MATLAB)	7-71
Tutorial: Configure the Component Function with the Cosimulation Wizard	7-71
Tutorial: Customize Callback Function	7-78
Tutorial: Run Cosimulation and Verify HDL Design	7-82
Verify Raised Cosine Filter Design Using Simulink	7-84
Simulink and Cosimulation Wizard Tutorial Overview	7-84
Tutorial: Set Up Tutorial Files (Simulink)	7-85
Tutorial: Launch Cosimulation Wizard (Simulink)	7-85

Tutorial: Configure the HDL Cosimulation Block with the Cosimulation Wizard	7-85
Tutorial: Create Test Bench to Verify HDL Design ...	7-98
Tutorial: Run Cosimulation and Verify HDL Design .	7-100
Help Button	7-103
Cosimulation Type	7-103
HDL Files	7-105
HDL Compilation	7-106
HDL Modules	7-107

HDL Cosimulation Reference

8

Startup for HDL Cosimulation	8-2
Machine Configuration Requirements	8-2
HDL Simulator Startup	8-4
HDL Verifier Libraries	8-10
Setup Diagnostics and Customization	8-15
Cross-Network Cosimulation	8-22
Why Perform Cross-Network Cosimulation?	8-22
Preparing for Cross-Network Cosimulation	8-22
Performing Cross-Network Cosimulation Using MATLAB	8-24
Performing Cross-Network Cosimulation Using Simulink	8-26
Test Bench and Component Function Writing	8-28
Writing Functions Using the HDL Instance Object ...	8-28
Writing Functions Using Port Information	8-32
Simulation Speed Improvement Tips	8-37
Obtaining Baseline Performance Numbers	8-37
Analyzing Simulation Performance	8-37
Cosimulating Frame-Based Signals with Simulink ...	8-38
Race Conditions in HDL Simulators	8-46
Avoiding Race Conditions	8-46

Potential Race Conditions in Simulink Cosimulation Sessions	8-46
Potential Race Conditions in MATLAB Cosimulation Sessions	8-47
Further Reading	8-48
Data Type Conversions	8-49
Converting HDL Data to Send to MATLAB	8-49
Array Indexing Differences Between MATLAB and HDL	8-51
Converting Data for Manipulation	8-52
Converting Data for Return to the HDL Simulator	8-53
Simulation Timescales	8-57
Overview to the Representation of Simulation Time	8-57
Defining the Simulink and HDL Simulator Timing Relationship	8-58
Setting the Timing Mode with HDL Verifier	8-58
Relative Timing Mode	8-60
Absolute Timing Mode	8-65
Timing Mode Usage Considerations	8-67
Setting HDL Cosimulation Block Port Sample Times	8-69
Clock, Reset, and Enable Signals	8-70
Driving Clocks, Resets, and Enables	8-70
Adding Signals Using Simulink Blocks	8-70
Creating Optional Clocks with the Clocks Pane of the HDL Cosimulation Block	8-71
Driving Signals by Adding Force Commands	8-74
TCP/IP Socket Ports	8-77

About FPGA-in-the-Loop Simulation

9

FPGA-in-the-Loop Simulation	9-2
What is FPGA-in-the-Loop Simulation?	9-2
What You Need To Know	9-4

FIL Preparation

10

FPGA-in-the-Loop Simulation Workflows	10-2
Download FPGA Board Support Package	10-3
HDL Verifier Support Packages for FPGA Boards	10-3
Install with Connection to Internet	10-4
Install Support Package Offline	10-5
Set Up FPGA Design Software Tools	10-7
Xilinx Software	10-7
Altera Software	10-7
Guided Hardware Setup	10-8
Select Board and Interface for Use with FPGA-in-the- Loop	10-8
Connection Requirements	10-8
Connection Setup	10-9
Configure Network Card on Host	10-13
PCIe Driver Installation	10-14
Verify Setup	10-14
Open the Example	10-14
Manual Hardware Setup	10-15
Step 1. Set Up FPGA Development Board	10-15
Step 2. Set Up Board Connection	10-16

Prepare DUT For FIL Interface Generation	10-23
Files and Information Required for FIL Generation	10-23
Apply FIL System Object Requirements	10-24
Apply FIL Block Requirements	10-27

11

FIL Interface Generation and Simulation

Block Generation with the FIL Wizard	11-2
Step 1: Set Up FPGA Design Software Tools	11-2
Step 2: Start FIL Wizard	11-3
Step 3: Set FIL Options for FIL Block	11-4
Step 4: Add HDL Source Files for FIL Block	11-6
Step 5: Verify DUT I/O Ports for FIL Block	11-8
Step 6: Specify Output Types for FIL Block	11-9
Step 7: Specify Build Options for FIL Block	11-10
Step 8: Initiate Build	11-11
System Object Generation with the FIL Wizard	11-12
Step 1: Set Up FPGA Design Software Tools	11-2
Step 2: Start FIL Wizard	11-13
Step 3: Set FIL Options for System Object	11-13
Step 4: Add HDL Source Files for System Object	11-16
Step 5: Verify DUT I/O Ports for System Object	11-18
Step 6: Specify Output Types for System Object	11-19
Step 7: Specify Build Options for System Object	11-21
Step 8: Initiate Build	11-22
Perform FPGA-in-the-Loop Simulation	11-25
FIL Block Setup and Simulation	11-25
FIL System Object Setup and Simulation	11-29

12

FIL Simulation with HDL Workflow Advisor for	
Simulink	12-2
Step 1: Start HDL Workflow Advisor	12-2
Step 2: Set Target	12-2
Step 3: Prepare Model for HDL Code Generation	12-3
Step 4: HDL Code Generation	12-3
Step 5: Set FPGA-in-the-Loop Options	12-3
Step 6: Generate FPGA Programming File and FPGA-in-the-Loop Model	12-7
Step 7: Load Programming File onto FPGA	12-9
Step 8: Run Simulation	12-9
FIL Simulation with HDL Workflow Advisor for	
MATLAB	12-10
Step 1: Start HDL Workflow Advisor	12-10
Step 2: Select Target	12-10
Step 3: Select Workflow	12-10
Step 4: Select FPGA-in-the-Loop Options	12-10
Step 5: Generate FPGA Programming File and Run Simulation	12-15

Troubleshooting FPGA-in-the-Loop

13

Troubleshooting FIL	13-2
---------------------------	------

FIL Examples

14

Verify HDL Implementation of PID Controller Using FPGA-in-the-Loop	14-2
Verify Digital Up-Converter Using FPGA-in-the-Loop	14-24

FPGA Board Customization	15-2
Feature Description	15-2
Custom Board Management	15-2
FPGA Board Requirements	15-3
Create Custom FPGA Board Definition	15-7
Create Xilinx KC705 Evaluation Board Definition	
File	15-8
Overview	15-8
What You Need to Know Before Starting	15-8
Start New FPGA Board Wizard	15-9
Provide Basic Board Information	15-10
Specify FPGA Interface Information	15-12
Enter FPGA Pin Numbers	15-13
Run Optional Validation Tests	15-15
Save Board Definition File	15-17
Use New FPGA Board	15-18
FPGA Board Manager	15-21
Introduction	15-21
Filter	15-23
Search	15-23
FIL Enabled/Turnkey Enabled	15-23
Create Custom Board	15-23
Add Board from File	15-23
Get More Boards	15-23
View/Edit	15-24
Remove	15-24
Clone	15-24
Validate	15-24
New FPGA Board Wizard	15-25
Basic Information	15-26
Interfaces	15-27
FIL I/O	15-31
Turnkey I/O	15-33
Validation	15-36
Finish	15-37

FPGA Board Editor	15-38
General Tab	15-38
Interface Tab	15-40

SystemC TLM Generation

How TLM Component Generation Works

16

TLM Generation Algorithms	16-2
The TLM Generation Process	16-4
Generated TLM Files	16-6

TLM Component Architecture

17

TLM Component Architecture	17-2
Overview of Component Features	17-2
Single or Multiple Sockets	17-5
Memory Mapping	17-5
Command and Status Register	17-10
Interrupt	17-17
Test and Set Register	17-17
Tunable Parameter Registers	17-18
Algorithm Execution	17-18
Register and Buffering	17-18
Temporal Decoupling	17-20
TLM Component Timing Values	17-25
TLM Component Naming and Packaging	17-26

Getting Started with TLM Component Generation

18

Getting Started with TLM Generator	18-2
--	------

Generate TLM Component

19

TLM Component Generation Workflow	19-2
Subsystem Guidelines and Limitations	19-3
Select TLM Generator System Target	19-4
Select TLM Mapping Options	19-7
Select TLM Processing Options	19-11
Select TLM Timing Options	19-13
Select TLM Testbench Options	19-15
Select TLM Compilation Options	19-17
Generate Component and Test Bench	19-20
Prepare IP-XACT File for Import	19-21
Required Information for Imported IP-XACT Files ..	19-21
Bus Interface Definition with No Memory Map	19-22
Bus Interface Definition with Memory Mapping	19-25
Contents of Generated IP-XACT File	19-29
Overview of Generated IP-XACT File	19-29
Generated Simulink Mapping	19-29
Generated Simulink Mapping in Memory Map	19-30
Generated Metadata	19-31

Implement Memory Map with SCML	19-33
What Is SCML?	19-33
Workflow	19-33
Generated Code	19-33

Run TLM Component Test Bench

20

Testing TLM Components	20-2
TLM Component Test Bench Overview	20-2
TLM Component Compilation	20-2
Automatic Verification of the Generated Component ..	20-3
Report Generation	20-3
Working with Configurations	20-3
Considerations When Creating a TLM Component Test Bench	20-3
 TLM Component Test Bench Generation Options	20-5
Verbose Messaging	20-5
Run-Time Timing Mode	20-5
Input and Output Buffer Triggering Modes	20-5
 Run TLM Component Test Bench	20-7

Export TLM Component to SystemC Environment

21

TLM Component Compiler Options	21-2
About the TLM Component Compiler Options	21-2
SystemC Installation Variables	21-2
TLM Include Path	21-3
Toolchain	21-3
SCML Installation Variables	21-3
 Export TLM Component	21-5
Identify Generated Files	21-5

Create Static Library with TLM Component	21-7
Create Standalone Executable with TLM Component	21-8

TLM Component Constructor and Default Parameters	21-11
---	--------------

Configuration Parameters for TLM Generator Target

22

TLM Component Generation	22-2
TLM Mapping	22-2
TLM Processing	22-11
TLM Timing	22-20
TLM Testbench	22-24
TLM Compilation	22-29

SystemVerilog DPI Component Generation

DPI Component Generation for MATLAB Function

23

DPI Component Generation with MATLAB	23-2
Supported MATLAB Data Types	23-3
Generated Shared Library	23-5
Generated Test Bench	23-6
Generated Outputs	23-7

Generated SystemVerilog Wrapper	23-8
Generated Control Signals	23-8
Generated Initialize Function	23-8
Limitations	23-9

DPI Component Generation (MATLAB)

24

Generate DPI Component Using MATLAB	24-2
Create MATLAB Function and Test Bench	24-2
Generate SystemVerilog DPI Component	24-4
Run Generated Test Bench in HDL Simulator	24-8
Use Generated DPI-C Functions in SystemVerilog ..	24-10
Port Generated Component and Test Bench to Linux .	24-11

DPI Component Generation for Simulink Subsystem

25

DPI Component Generation with Simulink	25-2
DPI-C Generation Overview	25-2
Supported Simulink Data Types	25-3
Generated SystemVerilog Wrapper	25-3
Customization	25-7
Generated Test Bench	25-8
Limitations	25-8
Determine Workflow for DPI-C Target	25-10
Windows 64 Host Workflow	25-10
Linux Host Workflow	25-12

SystemVerilog DPI Component Generation for Simulink

26

Generate SystemVerilog DPI Component	26-2
Select Options for Code Generation	26-2
Generate SystemVerilog DPI Component	26-4
Customize Generated SystemVerilog Code	26-6
Set Up Model for Customized Code Generation	26-6
Generate Customized SystemVerilog DPI Component .	26-9
Verify Generated Component Against Simulink Data	26-10
For Mentor Graphics ModelSim and QuestaSim	26-10
For the Cadence Incisive Simulator	26-10
Use Generated DPI-C Functions in SystemVerilog ..	26-11
Example	26-11
SystemVerilog DPI Component Test Point Access ...	26-13
Step 1. Choose Internal Signals	26-13
Step 2. Add Test Points	26-13
Step 3. Enable Component Interface	26-14
Step 4. Configure Access Function	26-15
Tune Gain Parameter During Simulation	26-16
Step 1. Create a Simple Gain Model	26-16
Step 2. Create Data Object for Gain Parameter	26-16
Step 3. Generate SystemVerilog DPI Component	26-19
Step 4. Add Parameter Tuning Code to SystemVerilog File	26-20
Step 5. Run Simulation with Parameter Change	26-21
Port and Build Shared Libraries and Simulator	
Projects	26-22
Port Generic DLL to Windows 32	26-22
Port ModelSim Project to Windows 32	26-23
Port Generic DLL to Linux	26-23
Port ModelSim Project to Linux	26-24
Port Incisive Project to Linux	26-24

Context-Sensitive Help for Generated SystemVerilog DPI Component

27

SystemVerilog DPI Pane	27-2
SystemVerilog DPI Overview	27-3
Customize SystemVerilog generated code	27-4
Source file template:	27-5
Generate test bench	27-6
Test point access	27-7

HDL Verification with Cosimulation

HDL Cosimulation Using MATLAB Test Bench Function

- “MATLAB as a Test Bench” on page 1-2
- “Create a MATLAB Test Bench” on page 1-4
- “Code HDL Modules for Verification Using MATLAB ” on page 1-5
- “Code an HDL Verifier Test Bench Function” on page 1-10
- “Place Test Bench on MATLAB Search Path” on page 1-18
- “Start Server for MATLAB—HDL Simulator Connection” on page 1-19
- “Start HDL Simulator” on page 1-21
- “Bind Test Bench Function Calls With `matlabtb`” on page 1-22
- “Schedule Options for a Test Bench Session” on page 1-26
- “Run MATLAB Test Bench Simulation” on page 1-29
- “Stop Test Bench Simulation” on page 1-36
- “Verify HDL Model with MATLAB Test Bench” on page 1-37
- “Automatic Cosimulation Verification” on page 1-54

MATLAB as a Test Bench

The HDL Verifier software provides a means for verifying HDL modules within the MATLAB environment. You do so by coding an HDL model and a MATLAB function that can share data with the HDL model. This chapter discusses the programming, interfacing, and scheduling conventions for MATLAB test bench functions that communicate with the HDL simulator.

MATLAB test bench functions let you verify the performance of the HDL model, or of components within the model. A test bench function drives values onto signals connected to input ports of an HDL design under test and receives signal values from the output ports of the module.

The following figure shows how a MATLAB function wraps around and communicates with the HDL simulator during a test bench simulation session.

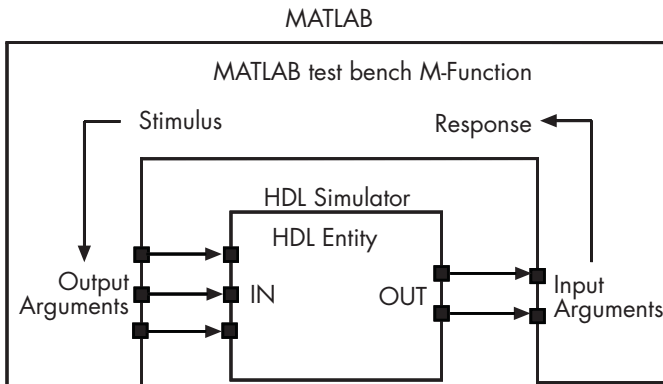

When linked with MATLAB, the HDL simulator functions as the client, with MATLAB as the server. The following figure shows a multiple-client scenario connecting to the server at TCP/IP socket port 4449.

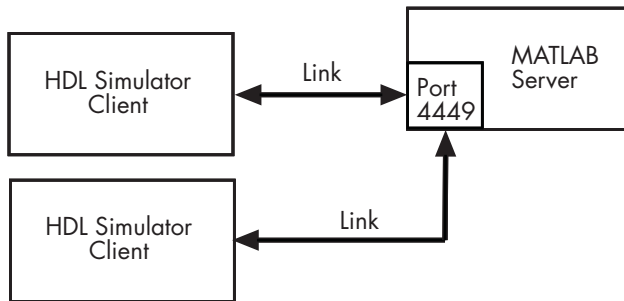

The MATLAB server can service multiple simultaneous HDL simulator sessions and HDL modules. However, you should follow recommended guidelines to help the server track the I/O associated with each module and session. The MATLAB server, which you start with the supplied MATLAB function `hdl_daemon`, waits for connection requests from instances of the HDL simulator running on the same or different computers. When the server receives a request, it executes the specified MATLAB function you have coded to perform tasks on behalf of a module in your HDL design. Parameters that you specify when you start the server indicate whether the server establishes shared memory or TCP/IP socket communication links.

Refer to “Machine Configuration Requirements” on page 8-2 for valid machine configurations.

Note: The programming, interfacing, and scheduling conventions for test bench functions and component functions are virtually identical. For the most part, the same procedures apply to both types of functions.

Create a MATLAB Test Bench

The following workflow steps describe how to create a MATLAB test bench session for cosimulation with the HDL simulator using HDL Verifier.

- 1 “Code HDL Modules for Verification Using MATLAB” on page 1-5
- 2 “Code an HDL Verifier Test Bench Function” on page 1-10
- 3 “Place Test Bench on MATLAB Search Path” on page 1-18
- 4 “Start Server for MATLAB—HDL Simulator Connection” on page 1-19
- 5 “Start HDL Simulator” on page 1-21
- 6 “Bind Test Bench Function Calls With `matlabtb`” on page 1-22
- 7 “Schedule Options for a Test Bench Session” on page 1-26
- 8 Set breakpoints for interactive HDL debug (optional).
- 9 “Run MATLAB Test Bench Simulation” on page 1-29
- 10 “Stop Test Bench Simulation” on page 1-36

Code HDL Modules for Verification Using MATLAB

In this section...

- “Overview to Coding HDL Modules for Verification with MATLAB” on page 1-5
- “Choose HDL Module Name for Use with MATLAB Test Bench” on page 1-5
- “Specify Port Direction Modes in HDL Module for Use with Test Bench” on page 1-6
- “Specify Port Data Types in HDL Modules for Use with Test Bench” on page 1-6
- “Compile and Elaborate HDL Design for Use with Test Bench” on page 1-7
- “Sample VHDL Entity Definition” on page 1-9

Overview to Coding HDL Modules for Verification with MATLAB

The most basic element of communication in the HDL Verifier interface is the HDL module. The interface passes all data between the HDL simulator and MATLAB as port data. The HDL Verifier software works with any existing HDL module. However, when you code an HDL module that is targeted for MATLAB verification, you should consider its name, the types of data to be shared between the two environments, and the direction modes. The sections within this chapter cover these topics.

The process for coding HDL modules for MATLAB verification is as follows:

- “Choose HDL Module Name for Use with MATLAB Test Bench” on page 1-5
- “Specify Port Direction Modes in HDL Module for Use with Test Bench” on page 1-6
- “Specify Port Data Types in HDL Modules for Use with Test Bench” on page 1-6
- “Compile and Elaborate HDL Design for Use with Test Bench” on page 1-7

Choose HDL Module Name for Use with MATLAB Test Bench

Although not required, when naming the HDL module, consider choosing a name that also can be used as a MATLAB function name. (Generally, naming rules for VHDL or Verilog and MATLAB are compatible.) By default, HDL Verifier software assumes that an HDL module and its simulation function share the same name. See “Bind Test Bench Function Calls With `matlabtb`” on page 1-22.

For details on MATLAB function-naming guidelines, see “MATLAB Programming Tips” on files and file names in the MATLAB documentation.

Specify Port Direction Modes in HDL Module for Use with Test Bench

In your module statement, you must specify each port with a direction mode (input, output, or bidirectional). The following table defines these three modes.

Use VHDL Mode...	Use Verilog Mode...	For Ports That...
IN	input	Represent signals that can be driven by a MATLAB function
OUT	output	Represent signal values that are passed to a MATLAB function
INOUT	inout	Represent bidirectional signals that can be driven by or pass values to a MATLAB function

Specify Port Data Types in HDL Modules for Use with Test Bench

This section describes how to specify data types compatible with MATLAB for ports in your HDL modules. For details on how the HDL Verifier interface converts data types for the MATLAB environment, see “Data Type Conversions” on page 8-49.

Note: If you use unsupported types, the HDL Verifier software issues a warning and ignores the port at run time. For example, if you define your interface with five ports, one of which is a VHDL access port, at run time, then the interface displays a warning and your code sees only four ports.

Port Data Types for VHDL Entities

In your entity statement, you must define each port that you plan to test with MATLAB with a VHDL data type that is supported by the HDL Verifier software. The interface can convert scalar and array data of the following VHDL types to comparable MATLAB types:

- STD_LOGIC, STD_ULONGIC, BIT, STD_LOGIC_VECTOR, STD_ULONGIC_VECTOR, and BIT_VECTOR
- INTEGER and NATURAL
- REAL
- TIME

- Enumerated types, including user-defined enumerated types and CHARACTER

The interface also supports all subtypes and arrays of the preceding types.

Note: The HDL Verifier software does not support VHDL extended identifiers for the following components:

- Port and signal names used in cosimulation
- Enum literals when used as array indices of port and signal names used in cosimulation

However, the software does support basic identifiers for VHDL.

Port Data Types for Verilog Modules

In your module definition, you must define each port that you plan to test with MATLAB with a Verilog port data type that is supported by the HDL Verifier software. The interface can convert data of the following Verilog port types to comparable MATLAB types:

- reg
- integer
- wire

Note: HDL Verifier software does not support Verilog escaped identifiers for port and signal names used in cosimulation. However, it does support simple identifiers for Verilog.

Compile and Elaborate HDL Design for Use with Test Bench

After you create or edit your HDL source files, use the HDL simulator compiler to compile and debug the code.

Compilation for ModelSim

You have the option of invoking the compiler from menus in the ModelSim[®] graphic interface or from the command line with the `vcom` command. The following sequence of

ModelSim creates and maps the design library `work` and compiles the VHDL file `modsimrand.vhd`:

```
ModelSim> vlib work
ModelSim> vmap work work
ModelSim> vcom modsimrand.vhd
```

The following sequence of ModelSim commands creates and maps the design library `work` and compiles the Verilog file `test.v`:

```
ModelSim> vlib work
ModelSim> vmap work work
ModelSim> vlog test.v
```

Note: You should provide read/write access to the signals that are connecting to the MATLAB session for cosimulation. For higher performance, you want to provide access only to those signals used in cosimulation. You can check read/write access through the HDL simulator—see HDL simulator documentation for details.

Compilation for Incisive

The Cadence Incisive[®] simulator allows for 1-step and 3-step processes for HDL compilation, elaboration, and simulation. The following Cadence Incisive simulator command compiles the Verilog file `test.v`:

```
sh> ncvlog test.v
```

The following Cadence Incisive simulator command compiles and elaborates the Verilog design `test.v`, and then loads it for simulation, in a single step:

```
sh> ncverilog +gui +access+rwc +linedebug test.v
```

The following sequence of Cadence Incisive simulator commands performs all the same processes in multiple steps:

```
sh> ncvlog -linedebug test.v
sh> ncelab -access +rwc test
sh> ncsim test
```

Note: You should provide read/write access to the signals that are connecting to the MATLAB session for cosimulation. The previous example shows how to provide read/

write access to all signals in your design. For higher performance, you want to provide access only to those signals used in cosimulation. See the description of the `+access` flag to `ncverilog` and the `-access` argument to `ncelab` for details.

For more examples, see the HDL Verifier tutorials and demos. For details on using the HDL compiler, see the simulator documentation.

Sample VHDL Entity Definition

This sample VHDL code fragment defines the entity `decoder`. By default, the entity is associated with MATLAB test bench function `decoder`.

The keyword `PORT` marks the start of the entity's port clause, which defines two `IN` ports—`isum` and `qsum`—and three `OUT` ports—`adj`, `dvalid`, and `odata`. The output ports drive signals to MATLAB function input ports for processing. The input ports receive signals from the MATLAB function output ports.

Both input ports are defined as vectors consisting of five standard logic values. The output port `adj` is also defined as a standard logic vector, but consists of only two values. The output ports `dvalid` and `odata` are defined as scalar standard logic ports. For information on how the HDL Verifier interface converts data of standard logic scalar and array types for use in the MATLAB environment, see “Data Type Conversions” on page 8-49.

```
ENTITY decoder IS
PORT (
    isum   : IN std_logic_vector(4 DOWNTO 0);
    qsum   : IN std_logic_vector(4 DOWNTO 0);
    adj    : OUT std_logic_vector(1 DOWNTO 0);
    dvalid : OUT std_logic;
    odata  : OUT std_logic);
END decoder ;
```

Code an HDL Verifier Test Bench Function

In this section...
“Process for Coding MATLAB HDL Verifier Functions” on page 1-10
“Syntax of a Test Bench Function” on page 1-11
“Sample MATLAB Test Bench Function” on page 1-11

Process for Coding MATLAB HDL Verifier Functions

Coding a MATLAB function that is to verify an HDL module or component requires that you follow specific coding conventions. You must also understand the data type conversions that occur, and program data type conversions for operating on data and returning data to the HDL simulator.

To code a MATLAB function that is to verify an HDL module or component, perform the following steps:

- 1** Learn the syntax for a MATLAB HDL Verifier test bench function (see “Syntax of a Test Bench Function” on page 1-11).
- 2** Understand how HDL Verifier software converts data from the HDL simulator for use in the MATLAB environment (see “Data Type Conversions” on page 8-49).
- 3** Choose a name for the MATLAB function (see “Bind HDL Module Component to MATLAB Test Bench Function” on page 1-24).
- 4** Define expected parameters in the function definition line (see “MATLAB Function Syntax and Function Argument Definitions” on page 8-32).
- 5** Determine the types of port data being passed into the function (see “MATLAB Function Syntax and Function Argument Definitions” on page 8-32).
- 6** Extract and, if applicable to the simulation, apply information received in the `portinfo` structure (see “Gaining Access to and Applying Port Information” on page 8-35).
- 7** Convert data for manipulation in the MATLAB environment, as applicable (see “Converting HDL Data to Send to MATLAB” on page 8-49).
- 8** Convert data that needs to be returned to the HDL simulator (see “Converting Data for Return to the HDL Simulator” on page 8-53).

Syntax of a Test Bench Function

The syntax of a MATLAB test bench function is

```
function [iport, tnext] = MyFunctionName(oport, tnow, portinfo)
```

See the “MATLAB Function Syntax and Function Argument Definitions” on page 8-32 for an explanation of each of the function arguments.

Sample MATLAB Test Bench Function

This section uses a sample MATLAB function to identify sections of a MATLAB test bench function required by the HDL Verifier software. You can see the full text of the code used in this sample in the section “MATLAB Builder EX Function Example: manchester_decoder.m” on page 1-15.

For ModelSim Users This example uses a VHDL entity and MATLAB Builder™ EX function code drawn from the decoder portion of the Manchester Receiver example. For the complete VHDL and function code listings, see the following files:

```
matlabroot\toolbox\edalink\extensions\modelstim\modelstimdemos\vhdl\manchester\decoder.vhd
```

```
matlabroot\toolbox\edalink\extensions\modelstim\modelstimdemos\manchester_decoder.m
```

As the first step to coding a MATLAB Builder EX test bench function, you must understand how the data modeled in the VHDL entity maps to data in the MATLAB Builder EX environment. The VHDL entity `decoder` is defined as follows:

```
ENTITY decoder IS
PORT (
  isum   : IN std_logic_vector(4 DOWNTO 0);
  qsum   : IN std_logic_vector(4 DOWNTO 0);
  adj    : OUT std_logic_vector(1 DOWNTO 0);
  dvalid : OUT std_logic;
  odata  : OUT std_logic
);
END decoder ;
```

The following discussion highlights key lines of code in the definition of the `manchester_decoder` MATLAB Builder EX function:

1 Specify the MATLAB function name and required parameters.

The following code is the function declaration of the `manchester_decoder` MATLAB Builder EX function.

```
function [iport,tnext] = manchester_decoder(oport,tnow,portinfo)
```

See “MATLAB Function Syntax and Function Argument Definitions” on page 8-32.

The function declaration performs the following actions:

- Names the function. This declaration names the function `manchester_decoder`, which differs from the entity name `decoder`. Because the names differ, the function name must be specified explicitly later when the entity is initialized for verification with the `matlabtb` or `matlabtbeval` function. See “Bind HDL Module Component to MATLAB Test Bench Function” on page 1-24.
- Defines required argument and return parameters. A MATLAB Builder EX test bench function *must* return two parameters, `iport` and `tnext`, and pass three arguments, `oport`, `tnow`, and `portinfo`, and *must* appear in the order shown. See “MATLAB Function Syntax and Function Argument Definitions” on page 8-32.

The function outputs must be initialized to empty values, as in the following code example:

```
tnext = [];  
iport = struct();
```

You should initialize the function outputs at the beginning of the function, to follow recommended best practice.

The following figure shows the relationship between the entity's ports and the MATLAB Builder EX function's `iport` and `oport` parameters.

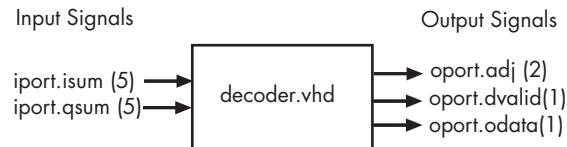

For more information on the required MATLAB Builder EX test bench function parameters, see “MATLAB Function Syntax and Function Argument Definitions” on page 8-32.

2 Make note of the data types of ports defined for the entity being simulated.

The HDL Verifier software converts HDL data types to comparable MATLAB Builder EX data types and vice versa. As you develop your MATLAB Builder EX function, you must know the types of the data that it receives from the HDL simulator and needs to return to the HDL simulator.

The VHDL entity defined for this example consists of the following ports

VHDL Example Port Definitions

Port	Direction	Type...	Converts to/Requires Conversion to...
isum	IN	STD_LOGIC_VECTOR(4 DOWNTO 0)	A 5-bit column or row vector of characters where each bit maps to a standard logic character literal.
qsum	IN	STD_LOGIC_VECTOR(4 DOWNTO 0)	A 5-bit column or row vector of characters where each bit maps to a standard logic character literal.
adj	OUT	STD_LOGIC_VECTOR(1 DOWNTO 0)	A 2-element column vector of characters. Each character matches a corresponding character literal that represents a logic state and maps to a single bit.

Port	Direction	Type...	Converts to/Requires Conversion to...
dvalid	OUT	STD_LOGIC	A character that matches the character literal representing the logic state.
odata	OUT	STD_LOGIC	A character that matches the character literal representing the logic state.

For more information on interface data type conversions, see “Data Type Conversions” on page 8-49.

3 Set up any required timing parameters.

The `tnext` assignment statement sets up timing parameter `tnext` such that the simulator calls back the MATLAB Builder EX function every nanosecond.

```
tnext = tnow+1e-9;
```

4 Convert output port data to MATLAB data types for processing.

The following code excerpt illustrates data type conversion of output port data.

```
%% Compute one row and plot
isum = isum + 1;
adj(isum) = mv12dec(oport.adj');
data(isum) = mv12dec([oport.dvalid oport.odata]);
.
.
.
```

The two calls to `mv12dec` convert the binary data that the MATLAB Builder EX function receives from the entity's output ports, `adj`, `dvalid`, and `odata` to unsigned decimal values that MATLAB Builder EX can compute. The function converts the 2-bit transposed vector `oport.adj` to a decimal value in the range 0 to 4 and `oport.dvalid` and `oport.odata` to the decimal value 0 or 1.

“MATLAB Function Syntax and Function Argument Definitions” on page 8-32 provides a summary of the types of data conversions to consider when coding simulation MATLAB functions.

5 Convert data to be returned to the HDL simulator.

The following code excerpt illustrates data type conversion of data to be returned to the HDL simulator.

```

if isum == 17
    iport.isum = dec2mvl(isum,5);
    iport.qsum = dec2mvl(qsum,5);
else
    iport.isum = dec2mvl(isum,5);
end

```

The three calls to `dec2mvl` convert the decimal values computed by MATLAB Builder EX to binary data that the MATLAB Builder EX function can deposit to the entity's input ports, `isum` and `qsum`. In each case, the function converts a decimal value to 5-element bit vector with each bit representing a character that maps to a character literal representing a logic state.

“Converting Data for Return to the HDL Simulator” on page 8-53 provides a summary of the types of data conversions to consider when returning data to the HDL simulator.

MATLAB Builder EX Function Example: `manchester_decoder.m`

```

function [iport,tnext] = manchester_decoder(oport,tnow,portinfo)
% MANCHESTER_DECODER Test bench for VHDL 'decoder'
% [IPORT,TNEXT]=MANCHESTER_DECODER(OPORT,TNOW,PORTINFO) -
% Implements a test of the VHDL decoder entity which is part
% of the Manchester receiver demo. This test bench plots
% the IQ mapping produced by the decoder.
%
%      iport          oport
%      +-----+
% isum -(5)->|         |-(2)-> adj
% qsum -(5)->| decoder |-(1)-> dvalid
%           |         |-(1)-> odata
%           +-----+
%
% isum - Inphase Convolution value
% qsum - Quadrature Convolution value
% adj  - Clock adjustment ('01','00','10')
% dvalid - Data validity ('1' = data is valid)
% odata - Recovered data stream

```

```

%
% Adjust = 0 (00b), generate full 16 cycle waveform

% Copyright 2003-2009 The MathWorks, Inc.

persistent isum;
persistent qsum;
%persistent ga;
persistent x;
persistent y;
persistent adj;
persistent data;
global testisdone;
% This useful feature allows you to manually
% reset the plot by simply typing: >manchester_decoder
tnext = [];
iport = struct();

if nargin == 0,
    isum = [];
    return;
end

if exist('portinfo') == 1
    isum = [];
end

tnext = tnow+1e-9;
if isempty(isum), %% First call
    scale = 9;
    isum = 0;
    qsum = 0;
    for k=1:2,
        ga(k) = subplot(2,1,k);
        axis([-1 17 -1 17]);
        ylabel('Quadrature');
        line([0 16],[8 8], 'Color', 'r', 'LineStyle', ':', 'LineWidth', 1)
        line([8 8],[0 16], 'Color', 'r', 'LineStyle', ':', 'LineWidth', 1)
    end
    xlabel('Inphase');
    subplot(2,1,1);
    title('Clock Adjustment (adj)');
    subplot(2,1,2);
    title('Data with Validity');
    iport.isum = '00000';
    iport.qsum = '00000';
    return;
end

% compute one row, then plot
isum = isum + 1;
adj(isum) = bin2dec(oport.adj');
data(isum) = bin2dec([oport.dvalid oport.odata]);

if isum == 17,

```



```
subplot(2,1,1);
for k=0:16,
    if adj(k+1) == 0, % Bang on!
        line(k,qsum,'color','k','Marker','o');
    elseif adj(k+1) == 1, %
        line(k,qsum,'color','r','Marker','<');
    else
        line(k,qsum,'color','b','Marker','>');
    end
end
subplot(2,1,2);
for k=0:16,
    if data(k+1) < 2, % Invalid
        line(k,qsum,'color','r','Marker','X');
    else
        if data(k+1) == 2, %Valid and 0!
            line(k,qsum,'color','g','Marker','o');
        else
            line(k,qsum,'color','k','Marker','.');
        end
    end
end

isum = 0;
qsum = qsum + 1;
if qsum == 17,
    qsum = 0;
    disp('done');
    tnext = []; % suspend callbacks
    testisdone = 1;
    return;
end
iport.isum = dec2bin(isum,5);
iport.qsum = dec2bin(qsum,5);
else
iport.isum = dec2bin(isum,5);
end
```

Place Test Bench on MATLAB Search Path

In this section...

“Use MATLAB which Function to Find Test Bench” on page 1-18

“Add Test Bench Function to MATLAB Search Path” on page 1-18

Use MATLAB which Function to Find Test Bench

The MATLAB function that you are associating with an HDL component must be on the MATLAB search path or reside in the current working folder (see the MATLAB `cd` function). To verify whether the function is accessible, use the MATLAB `which` function. The following call to `which` checks whether the function `MyVhdlFunction` is on the MATLAB search path, for example:

```
which MyVhdlFunction  
/work/incisive/MySym/MyVhdlFunction.m
```

If the specified function is on the search path, `which` displays the complete path to the function. If the function is not on the search path, `which` informs you that the file was not found.

Add Test Bench Function to MATLAB Search Path

To add a MATLAB function to the MATLAB search path, open the Set Path window by clicking **File > Set Path**, or use the `addpath` command. Alternatively, for temporary access, you can change the MATLAB working folder to a desired location with the `cd` command.

Start Server for MATLAB—HDL Simulator Connection

In this section...

“Start MATLAB Server for Test Bench Session” on page 1-19

“Example of Starting MATLAB Server for Test Bench Session” on page 1-20

Start MATLAB Server for Test Bench Session

Start the MATLAB server as follows:

- 1 Start MATLAB.
- 2 In the MATLAB Command Window, call the `hdldaemon` function with property name/property value pairs that specify whether the HDL Verifier software is to perform the following tasks:
 - Use shared memory or TCP/IP socket communication
 - Return time values in seconds or as 64-bit integers

See `hdldaemon` reference documentation for when and how to specify property name/property value pairs and for more examples of using `hdldaemon`.

The communication mode that you specify (shared memory or TCP/IP sockets) must match what you specify for the communication mode when you initialize the HDL simulator for use with a MATLAB cosimulation session using the `matlabtb` or `matlabcp` function. In addition, if you specify TCP/IP socket mode, the socket port that you specify with `hdldaemon` and `matlabtb` or `matlabcp` must match. See “TCP/IP Socket Ports” on page 8-77 for more information .

The MATLAB server can service multiple simultaneous HDL simulator modules and clients. However, your code must track the I/O associated with each entity or client.

Note: You cannot begin an HDL Verifier transaction between MATLAB and the HDL simulator from MATLAB. The MATLAB server simply responds to function call requests that it receives from the HDL simulator.

Example of Starting MATLAB Server for Test Bench Session

The following command specifies using socket communication on port 4449 and a 64-bit time resolution format for the MATLAB function's output ports.

```
hdldaemon('socket', 4449, 'time', 'int64')
```

Start HDL Simulator

In this section...

“Start the HDL Simulator for Test Bench Session” on page 1-21

“Load an HDL Design for Verification” on page 1-21

Start the HDL Simulator for Test Bench Session

Start the HDL simulator directly from MATLAB by calling the HDL Verifier function `vsim` or `nclaunch`.

```
>>vsim
```

You can call `vsim` or `nclaunch` with additional parameters; see the reference pages for details.

You must make sure the HDL simulator executables — also called `vsim` (ModelSim) and `nclaunch` (Cadence Incisive) — are on the system path. See your system documentation for instruction on setting environment variables.

Linux Users Make sure the HDL simulator executable is still on the system path after the shell is launched from MATLAB. If it is not, make sure the shell startup file does not remove it from the path environment variable.

Load an HDL Design for Verification

After you start the HDL simulator from MATLAB with a call to `vsim` or `nclaunch`, load an instance of an HDL module for verification or visualization with the function `vsimmatlab` or `hdlsimmatlab`. At this point, you should have coded and compiled your HDL model. Issue the function `vsimmatlab` or `hdlsimmatlab` for each instance of an entity or module in your model that you want to cosimulate. For example (for use with Incisive®):

```
hdlsimmatlab work.osc_top
```

This command loads the HDL Verifier library, opens a simulation workspace for `osc_top`, and display a series of messages in the HDL simulator command window as the simulator loads the entity (see example for remaining code).

Bind Test Bench Function Calls With `matlabtb`

In this section...

“Invoke MATLAB Test Bench Command `matlabtb`” on page 1-22

“Bind HDL Module Component to MATLAB Test Bench Function” on page 1-24

Invoke MATLAB Test Bench Command `matlabtb`

You invoke `matlabtb` by issuing the command in the HDL simulator. See the Examples section of the `matlabtb` reference page for several examples of invoking `matlabtb`.

Be sure to follow the path specifications for MATLAB test bench sessions when invoking `matlabtb`, as explained in “Specify HDL Signal/Port and Module Paths for MATLAB Test Bench Cosimulation” on page 1-22.

For instructions in issuing the `matlabtb` command, see “Run MATLAB Test Bench Simulation” on page 1-29.

Specify HDL Signal/Port and Module Paths for MATLAB Test Bench Cosimulation

HDL Verifier software has specific requirements for specifying HDL design hierarchy, the syntax of which is described in the following sections: one for Verilog at the top level, and one for VHDL at the top level. Do not use a file name hierarchy in place of the design hierarchy name.

The rules stated in this section apply to signal/port and module path specifications for MATLAB cosimulation sessions. Other specifications may work but the HDL Verifier software does not officially recognize nor support them.

In the following example:

```
matlabtb u_osc_filter -mfunc oscfilter
```

`u_osc_filter` is the top-level component. If you specify a subcomponent, you must follow valid module path specifications for MATLAB cosimulation sessions.

Path Specifications for MATLAB Link Sessions with Verilog Top Level

- The path specification must start with a top-level module name.

- The path specification can include "." or "/" path delimiters, but it cannot include mixed delimiters.
- The leaf module or signal must match the HDL language of the top-level module.

The following examples show valid signal and module path specifications:

```
top.port_or_sig
/top/sub/port_or_sig
top
top/sub
top.sub1.sub2
```

The following examples show *invalid* signal and module path specifications:

- `top.sub/port_or_sig`

Why this specification is invalid: You cannot use mixed delimiters.

- `:sub:port_or_sig`

:

:sub

Why this specification is invalid: When you use VHDL-specific delimiters you limit the interoperability with paths when moving between HDL simulators and between VHDL and Verilog.

Path Specifications for MATLAB Link Sessions with VHDL Top Level

- The path specification can include the top-level module name, but you do not have to include it.
- The path specification can include "." or "/" path delimiters, but it cannot include mixed delimiters.
- The leaf module or signal must match the HDL language of the top-level module.

Examples for ModelSim and Incisive Users

The following examples show valid signal and module path specifications:

```
top.port_or_sig
/sub/port_or_sig
top
top/sub
```

top.sub1.sub2

The following examples show *invalid* signal and module path specifications:

- top.sub/port_or_sig

Why this specification is invalid: You cannot use mixed delimiters.

- :sub:port_or_sig

:

:sub

Why this specification is invalid: When you use VHDL-specific delimiters you limit the interoperability with paths when moving between HDL simulators and between VHDL and Verilog.

Bind HDL Module Component to MATLAB Test Bench Function

By default, the HDL Verifier software assumes that the name for a MATLAB function matches the name of the HDL module that the function verifies. When you create a test bench or component function that has a different name than the design under test, you must associate the design with the MATLAB function using the `-mfunc` argument to `matlabtb`. This argument associates the HDL module instance to a MATLAB function that has a different name from the HDL instance.

For more information on the `-mfunc` argument and for a full list of `matlabtb` parameters, see the `matlabtb` function reference.

For details on MATLAB function naming guidelines, see "MATLAB Programming Tips" on files and file names in the MATLAB documentation.

Example of Binding Test Bench and Component Function Calls

In this first example, you form an association between the `inverter_v1` component and the MATLAB test bench function `inverter_tb` by invoking the function `matlabtb` with the `-mfunc` argument when you set up the simulation.

```
matlabtb inverter_v1 -mfunc inverter_tb
```

The `matlabtb` command instructs the HDL simulator to call back the `inverter_tb` function when `inverter_v1` executes in the simulation.

In this second example, you bind the model `osc_top.u_osc_filter` to the component function `oscfilter`:

```
matlabcp osc_top.u_osc_filter -mfunc oscfilter
```

When the HDL simulator calls the `oscfilter` callback, the function knows to operate on the model `osc_top.u_osc_filter`.

Schedule Options for a Test Bench Session

In this section...

“About Scheduling Options for Test Bench Sessions” on page 1-26

“Schedule Test Bench Session Using `matlabtb` Arguments” on page 1-26

“Schedule Test Bench Functions With the `tnext` Parameter” on page 1-27

About Scheduling Options for Test Bench Sessions

There are two ways to schedule the invocation of a MATLAB function:

- Using the arguments to the HDL Verifier function `matlabtb` or `matlabcp`
- Inside the MATLAB function using the `tnext` parameter

The two types of scheduling are not mutually exclusive. You can combine the `matlabtb` or `matlabcp` timing arguments and the `tnext` parameter of a MATLAB function to schedule test bench or component session callbacks.

Schedule Test Bench Session Using `matlabtb` Arguments

By default, the HDL Verifier software invokes a MATLAB test bench or component function once (at the time that you make the call to `matlabtb/matlabcp`). If you want to apply more control, and execute the MATLAB function more than once, use the command scheduling options. With these options, you can specify when and how often the HDL Verifier software invokes the relevant MATLAB function. If applicable, modify the function or specify timing arguments when you begin a MATLAB test bench or component function session with the `matlabtb/matlabcp` function.

You can schedule a MATLAB test bench or component function to execute using the command arguments under any of the following conditions:

- **Discrete time values**—Based on time specifications that can also include repeat intervals and a stop time
- **Rising edge**—When a specified signal experiences a rising edge
 - VHDL: Rising edge is {0 or L} to {1 or H}.
 - Verilog: Rising edge is the transition from 0 to x, z, or 1, and from x or z to 1.

- **Falling edge**—When a specified signal experiences a falling edge
 - VHDL: Falling edge is {1 or H} to {0 or L}.
 - Verilog: Falling edge is the transition from 1 to x, z, or 0, and from x or z to 0.
- **Signal state change**—When a specified signal changes state, based on a list using the `-sensitivity` argument to `matlabtb`.

Schedule Test Bench Functions With the `tnext` Parameter

You can control the callback timing of a MATLAB function by using that function's `tnext` parameter. This parameter passes a time value to the HDL simulator, and the value gets added to the simulation schedule for that function. If the function returns a null value (`[]`), the software does not add any new entries to the schedule.

You can set the value of `tnext` to a value of type `double` or `int64`. Specify `double` to express the callback time in seconds. For example, to schedule a callback in 1 ns, specify:

```
tnext = 1e-9
```

Specify `int64` to convert to an integer multiple of the current HDL simulator time resolution limit. For example: if the HDL simulator time precision is 1 ns, to schedule a callback at 100 ns, specify:

```
tnext=int64(100)
```

Note: The `tnext` parameter represents time from the start of the simulation. Therefore, `tnext` must always be greater than `tnow`. If it is less, the software does not schedule a callback.

For more information on `tnext` and the function prototype, see “MATLAB Function Syntax and Function Argument Definitions” on page 8-32.

Examples of Scheduling with `tnext`

In this first example, each time the HDL simulator calls the test bench function (via HDL Verifier), `tnext` schedules the next callback to the MATLAB function for 1 ns later, relative to the current simulation time:

```
tnext = [];
```

```
.  
.   
.   
tnext = tnow+1e-9;
```

Using `tnext` you can dynamically decide the callback scheduling based on criteria specific to the operation of the test bench. For example, you can decide to stop scheduling callbacks when a data signal has a certain value:

```
    if qsum == 17,  
        qsum = 0;  
        disp('done');  
        tnext = []; % suspend callbacks  
        testisdone = 1;  
        return;  
    end
```

This next example demonstrates scheduling a component session using `tnext`. In the Oscillator example, the `oscfilter` function calculates a time interval at which the HDL simulator calls the callbacks. The component function calculates this interval on the first call to `oscfilter` and stores the result in the variable `fastestrate`. The variable `fastestrate` represents the sample period of the fastest oversampling rate supported by the filter. The function derives this rate from a base sampling period of 80 ns.

The following assignment statement sets the timing parameter `tnext`. This parameter schedules the next callback to the MATLAB component function, relative to the current simulation time (`tnow`).

```
tnext = tnow + fastestrate;
```

The function returns a new value for `tnext` each time the HDL simulator calls the function.

Run MATLAB Test Bench Simulation

In this section...

- “Process for Running MATLAB Test Bench Cosimulation” on page 1-29
- “Check MATLAB Server's Link Status for Test Bench Cosimulation” on page 1-29
- “Run Test Bench Cosimulation” on page 1-30
- “Apply Stimuli to Test Bench Session with force Command” on page 1-33
- “Restart Test Bench Simulation” on page 1-35

Process for Running MATLAB Test Bench Cosimulation

To start and control the execution of a simulation in the MATLAB environment, perform the following steps:

- 1 “Check MATLAB Server's Link Status for Test Bench Cosimulation” on page 1-29
- 2 “Run MATLAB Test Bench Simulation” on page 1-29
- 3 “Apply Stimuli to Test Bench Session with force Command” on page 1-33
- 4 “Restart Test Bench Simulation” on page 1-35 (if applicable).

Check MATLAB Server's Link Status for Test Bench Cosimulation

The first step to starting an HDL simulator and MATLAB test bench or component function session is to check the link status of the MATLAB server. Is the server running? If the server is running, what mode of communication and, if applicable, what TCP/IP socket port is the server using for its links? You can retrieve this information by using the MATLAB function `hdldaemon` with the `'status'` option. For example:

```
hdldaemon('status')
```

The function displays a message that indicates whether the server is running and, if it is running, the number of connections it is handling. For example:

```
HDLDaemon socket server is running on port 4449 with 0 connections
```

If the server is not running, the message reads

HDLDaemon is NOT running

See the Options: Inputs section in the `hdldaemon` reference documentation for information on determining the mode of communication and the TCP/IP socket in use.

Run Test Bench Cosimulation

You can run a cosimulation session using both the MATLAB and HDL simulator GUIs (typical) or, to reduce memory demand, you can run the cosimulation using the command line interface (CLI) or in batch mode.

- “Cosimulation with MATLAB Using the HDL Simulator GUI” on page 1-30
- “Cosimulation with MATLAB Using the Command Line Interface (CLI)” on page 1-32
- “Cosimulation with MATLAB Using Batch Mode” on page 1-33

Cosimulation with MATLAB Using the HDL Simulator GUI

These steps describe a typical sequence for running a simulation interactively from the main HDL simulator window:

- 1 Set breakpoints in the HDL and MATLAB code to verify and analyze simulation progress.

How you set breakpoints in the HDL simulator will vary depending on what simulator application you are using.

In MATLAB, there are several ways you can set breakpoints; for example, by using the **Set/Clear Breakpoint** button on the toolbar.

- 2 Issue `matlabtb` command at the HDL simulator prompt.

When you begin a specific test bench or component session, you specify parameters that identify the following information:

- The mode and, if applicable, TCP/IP data for connecting to a MATLAB server (see `matlabtb` reference)
- The MATLAB function that is associated with and executes on behalf of the HDL instance. See “Bind HDL Module Component to MATLAB Test Bench Function” on page 1-24.

- Timing specifications and other control data that specifies when the module's MATLAB function is to be called. See “Schedule Options for a Test Bench Session” on page 1-26.

For example:

```
hdlsim> matlabtb osc_top -sensitivity /osc_top/sine_out  
-socket 4448 -mfunc hosctb
```

- 3 Start the simulation by entering the HDL simulator `run` command.

The `run` command offers a variety of options for applying control over how a simulation runs (refer to your HDL simulator documentation for details). For example, you can specify that a simulation run for several time steps.

The following command instructs the HDL simulator to run the loaded simulation for 50000 time steps:

```
run 50000
```

- 4 Step through the simulation and examine values.

How you step through the simulation in the HDL simulator will vary depending on what simulator application you are using.

In MATLAB, there are several ways you can step through code; for example, by clicking the **Step** toolbar button.

- 5 When you block execution of the MATLAB function, the HDL simulator also blocks and remains blocked until you clear all breakpoints in the function's code.
- 6 Resume the simulation, as desired.

How you resume the simulation in the HDL simulator will vary depending on what simulator application you are using.

In MATLAB, there are several ways you can resume the simulation; for example, by clicking the **Continue** toolbar button.

The following HDL simulator command resumes a simulation:

```
run -continue
```

For more information on HDL simulator and MATLAB debugging features, see the HDL simulator documentation and MATLAB online help or documentation.

Cosimulation with MATLAB Using the Command Line Interface (CLI)

Running your cosimulation session using the command-line interface allows you to interact with the HDL simulator during cosimulation, which can be helpful for debugging.

To use the CLI, specify "CLI" as the property value for the run mode parameter of the HDL Verifier HDL simulator launch command.

The Tcl command you build to pass to the HDL simulator launch command must contain the run command or no cosimulation will take place.

Caution Close the terminal window by entering `quit -f` at the command prompt. Do not close the terminal window by clicking the "X" in the upper right-hand corner. This causes a memory-type error to be issued from the system. This is not a bug with HDL Verifier but just the way the HDL simulator behaves in this context.

You can type CTRL+C to interrupt and terminate the simulation in the HDL simulator but this action also causes the memory-type error to be displayed.

Specify CLI mode with `nc1launch` (Cadence Incisive)

Issue the `nc1launch` command with "CLI" as the `runmode` property value, as follows (example entered into the MATLAB editor):

```
tclcmd = { ['cd ',projdir],...
          ['exec ncvlog ' srcfile],...
          'exec ncelab -access +wc lowpass_filter',...
          ['hdlsimmatlab -gui lowpass_filter ', ...
          ' -input "{@matlabtb lowpass_filter 10ns -repeat 10ns ...
-mfunc filter_tb incisive}"',...
          ' -input "{@force lowpass_filter.clk_enable 1 -after 0ns}"',...
          ' -input "{@force lowpass_filter.reset 1 -after 0ns 0 -after 22ns}"',...
          ' -input "{@force lowpass_filter.clk 1 -after 0ns 0 -after 5ns ...
-repeat 10ns}"',...
          ' -input "{@deposit lowpass_filter.filter_in 0}"',...
          ];

nc1launch('tclstart',tclcmd,'runmode','CLI');
```

Specify CLI mode with `vsim` (Mentor Graphics ModelSim)

Issue the `vsim` command with "CLI" as the `runmode` property value, as follows (example entered into the MATLAB editor):

```
tclcmd = { ['cd ',unixprojdir],...
```



```

    'vlib work',... %create library (if applicable)
    'force /osc_top/clk_enable 1 0',...
    'force /osc_top/reset 1 0, 0 120 ns',...
    'force /osc_top/clk 1 0 ns, 0 40 ns -r 80ns',...
  };

vsim('tclstart',tclcmd,'runmode','CLI');

```

Cosimulation with MATLAB Using Batch Mode

Running your cosimulation session in batch mode allows you to keep the process in the background, reducing demand on memory by disengaging the GUI.

To use the batch mode, specify "Batch" as the property value for the run mode parameter of the HDL Verifier HDL simulator launch command. After you issue the HDL Verifier HDL simulator launch command with batch mode specified, start the simulation in Simulink®. To stop the HDL simulator before the simulation is completed, issue the `breakHdlSim` command.

Specify Batch mode with `nclaunch` (Cadence Incisive)

Issue the `nclaunch` command with "Batch" as the `runmode` parameter, as follows:

```
nclaunch('tclstart',manchestercmds,'runmode','Batch')
```

You can also set `runmode` to 'Batch with Xterm', which starts the HDL simulator in the background but shows the session in an Xterm.

Specify Batch mode with `vsim` (Mentor Graphics ModelSim)

On Windows®, specifying batch mode causes ModelSim to be run in a non-interactive command window. On Linux®, specifying batch mode causes ModelSim to be run in the background with no window.

Issue the `vsim` command with 'Batch' as the `runmode` parameter, as follows:

```
>> vsim('tclstart',manchestercmds,'runmode','Batch')
```

Apply Stimuli to Test Bench Session with `force` Command

After you establish a connection between the HDL simulator and MATLAB, you can then apply stimuli to the test bench or component cosimulation environment. One way of applying stimuli is through the `iport` parameter of the linked MATLAB function. This parameter forces signal values by deposit.

Other ways to apply stimuli include issuing `force` commands in the HDL simulator main window (for ModelSim, you can also use the **Edit > Clock** option in the **ModelSim Signals** window).

For example, consider the following sequence of `force` commands:

- Incisive

```
force osc_top.clk_enable 1 -after 0ns
force osc_top.reset 0 -after 0ns 1 -after 40ns 0 -after 120ns
force osc_top.clk 1 -after 0ns 0 -after 40ns -repeat 80ns
```

- ModelSim

```
VSIM n> force clk 0 0 ns, 1 5 ns -repeat 10 ns
VSIM n> force clk_en 1 0
VSIM n> force reset 0 0
```

These commands drive the following signals:

- The `clk` signal to 0 at 0 nanoseconds after the current simulation time and to 1 at 5 nanoseconds after the current HDL simulation time. This cycle repeats starting at 10 nanoseconds after the current simulation time, causing transitions from 1 to 0 and 0 to 1 every 5 nanoseconds, as the following diagram shows.

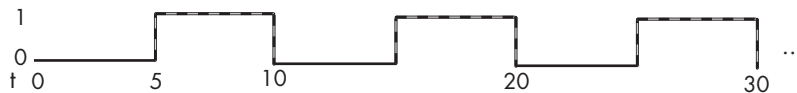

For example,

```
force /foobar/clk 0 0, 1 5 -repeat 10
```

- The `clk_en` signal to 1 at 0 nanoseconds after the current simulation time.
- The `reset` signal to 0 at 0 nanoseconds after the current simulation time.

Incisive Users: Using HDL to Code Clock Signals Instead of the `force` Command

You should consider using HDL to code clock signals as `force` is a lower performance solution in the current version of Cadence Incisive simulators.

The following are ways that a periodic force might be introduced:

- Via the Clock pane in the HDL Cosimulation block

- Via pre/post Tcl commands in the HDL Cosimulation block
- Via a user-input Tcl script to `ncsim`

All three approaches may lead to performance degradation.

Restart Test Bench Simulation

Because the HDL simulator issues the service requests during a MATLAB cosimulation session, you must restart the session from the HDL simulator. To restart a session, perform the following steps:

- 1** Make the HDL simulator your active window, if your input focus was not already set to that application.
- 2** Reload HDL design elements and reset the simulation time to zero.
- 3** Reissue the `matlabtb` or `matlabcp` command.

Note: To restart a simulation that is in progress, issue a break command and end the current simulation session before restarting a new session.

Stop Test Bench Simulation

When you are ready to stop a test bench session, it is best to do so in an orderly way to avoid possible corruption of files and to see that all application tasks shut down cleanly. You should stop a session as follows:

- 1** Make the HDL simulator your active window, if your input focus was not already set to that application.
- 2** Halt the simulation. You must quit the simulation at the HDL simulator side or MATLAB may hang until the simulator is quit.
- 3** Close your project.
- 4** Exit the HDL simulator, if you are finished with the application.
- 5** Quit MATLAB, if you are finished with the application. If you want to shut down the server manually, stop the server by calling `hdldaemon` with the 'kill' option:

```
hdldaemon('kill')
```

For more information on closing HDL simulator sessions, see the HDL simulator documentation.

Verify HDL Model with MATLAB Test Bench

In this section...

- “Tutorial Overview” on page 1-37
- “Set Up Tutorial Files” on page 1-38
- “Start the MATLAB Server” on page 1-38
- “Start ModelSim Simulator and Set Up for Cosimulation” on page 1-40
- “Develop VHDL Code” on page 1-41
- “Compile VHDL” on page 1-43
- “Develop MATLAB Function” on page 1-44
- “Load Simulation” on page 1-46
- “Run Simulation” on page 1-48
- “Shut Down Simulation” on page 1-52

Tutorial Overview

This tutorial guides you through the basic steps for setting up an HDL Verifier application that uses MATLAB to verify a simple HDL design. In this tutorial, you develop, simulate, and verify a model of a pseudorandom number generator based on the Fibonacci sequence. The model is coded in VHDL.

Note: This tutorial demonstrates creating and running a test bench using ModelSim SE 6.5. If you are not using this version, the messages and screen images from ModelSim may not appear to you exactly as they do in this tutorial.

This tutorial requires MATLAB, the HDL Verifier software, and the ModelSim HDL simulator.

In this tutorial, you will perform the following steps:

- 1 “Set Up Tutorial Files” on page 1-38
- 2 “Start the MATLAB Server” on page 1-38
- 3 “Start ModelSim Simulator and Set Up for Cosimulation” on page 1-40

- 4 “Develop VHDL Code” on page 1-41
- 5 “Develop VHDL Code” on page 1-41
- 6 “Develop MATLAB Function” on page 1-44
- 7 “Load Simulation” on page 1-46
- 8 “Run Simulation” on page 1-48
- 9 “Shut Down Simulation” on page 1-52

Set Up Tutorial Files

To help others have access to copies of the tutorial files, set up a folder for your own tutorial work:

- 1 Create a folder outside the scope of your MATLAB installation folder into which you can copy the tutorial files. The folder must be writable. This tutorial assumes that you create a folder named `MyPlayArea`.
- 2 Copy the following files to the folder you just created:

```
matlabroot\toolbox\edalink\extensions\modelsim\modelsimdemos  
\modsimrand_plot.m
```

```
matlabroot\toolbox\edalink\extensions\modelsim\modelsimdemos\VHDL  
\modsimrand\modsimrand.vhd
```

Start the MATLAB Server

This section describes starting MATLAB, setting up the current folder for completing the tutorial, starting the MATLAB server component, and checking for client connections, using shared memory or TCP/IP socket mode. These instructions assume you are familiar with the MATLAB user interface.

Perform the following steps:

- 1 Start MATLAB.
- 2 Set your MATLAB current folder to the folder you created in “Set Up Tutorial Files” on page 1-38.
- 3 Verify that the MATLAB server is running by calling function `hdldaemon` with the `'status'` option in the MATLAB Command Window as shown here:

```
hdldaemon('status')
```

If the server is not running, the function displays

```
HDLDaemon is NOT running
```

If the server is running in TCP/IP socket mode, the message reads

```
HDLDaemon socket server is running on Port portnum with 0 connections
```

If the server is running in shared memory mode, the message reads

```
HDLDaemon shared memory server is running with 0 connections
```

If the server is not currently running, skip to step 5.

4 Shut down the server by typing

```
hdldaemon('kill')
```

You will see the following message that confirms that the server was shut down.

```
HDLDaemon server was shutdown
```

5 Start the server in TCP/IP socket mode by calling `hdldaemon` with the property name/property value pair `'socket' 0`. The value 0 specifies that the operating system assign the server a TCP/IP socket port that is available on your system. For example

```
hdldaemon('socket', 0)
```

The server informs you that it has started by displaying the following message. The *portnum* will be specific to your system:

```
HDLDaemon socket server is running on Port portnum with 0 connections
```

Make note of *portnum* as you will need it when you issue the `matlabtb` command in “Load Simulation” on page 1-46.

You can alternatively specify that the MATLAB server use shared memory communication instead of TCP/IP socket communication; however, for this tutorial we will use socket communication as means of demonstrating this type of connection. For details on how to specify the various options, see the description of `hdldaemon`.

Start ModelSim Simulator and Set Up for Cosimulation

This section describes the basic procedure for starting the ModelSim software and setting up a ModelSim design library. These instructions assume you are familiar with the ModelSim user interface.

Perform the following steps:

- 1 Start ModelSim from the MATLAB environment by calling the function `vsim` in the MATLAB Command Window.

```
vsim
```

This function launches and configures ModelSim for use with the HDL Verifier software. The first folder of ModelSim matches your MATLAB current folder.

- 2 Verify the current ModelSim folder. You can verify that the current ModelSim folder matches the MATLAB current folder by entering the `ls` command in the ModelSim command window.



```
Transcript
ModelSim> ls
# compile_and_launch.tcl
# modsimrand.vhd
# modsimrand_plot.m
# transcript

ModelSim> ]
```

The command should list the files `modsimrand.vhd`, `modsimrand_plot.m`, `transcript`, and `compile_and_launch.tcl`.

If it does not, change your ModelSim folder to the current MATLAB folder. You can find the current MATLAB folder by looking in the Current Folder Browser or by viewing the Current folder navigation bar. In ModelSim, you can change the working folder by issuing the command

```
cd directory
```

Where *directory* is the folder you want to work from. Or you may also change directory by selecting **File > Change Directory...**

- 3 Create a design library to hold your compilation results. To create the library and required `_info` file, enter the `vlib` and `vmap` commands as follows:

```
ModelSim> vlib work
```

```
ModelSim> vmap work work
```

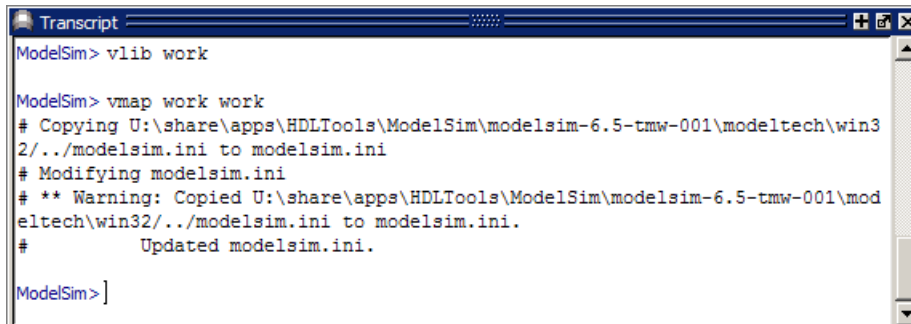

```
Transcript
ModelSim> vlib work

ModelSim> vmap work work
# Copying U:\share\apps\HDLTools\ModelSim\modelsim-6.5-tmw-001\modeltech\win32\..\modelsim.ini to modelsim.ini
# Modifying modelsim.ini
# ** Warning: Copied U:\share\apps\HDLTools\ModelSim\modelsim-6.5-tmw-001\modeltech\win32\..\modelsim.ini to modelsim.ini.
# Updated modelsim.ini.

ModelSim> ]
```

Note: You must use the ModelSim **File** menu or `vlib` command to create the library folder so that the required `_info` file is created. Do not create the library with operating system commands.

Develop VHDL Code

After setting up a design library, typically you would use the ModelSim Editor to create and modify your HDL code. For this tutorial, you do not need to create the VHDL code yourself. Instead, open and examine the existing file `modsimrand.vhd`. This section highlights areas of code in `modsimrand.vhd` that are of interest for a ModelSim and MATLAB test bench.

If you choose not to examine the HDL code at this time, skip to “Compile VHDL” on page 1-43.

You can open `modsimrand.vhd` in the edit window with the `edit` command, as follows:

```
ModelSim> edit modsimrand.vhd
```



ModelSim opens its **edit** window and displays the VHDL code for `modsimrand.vhd`.

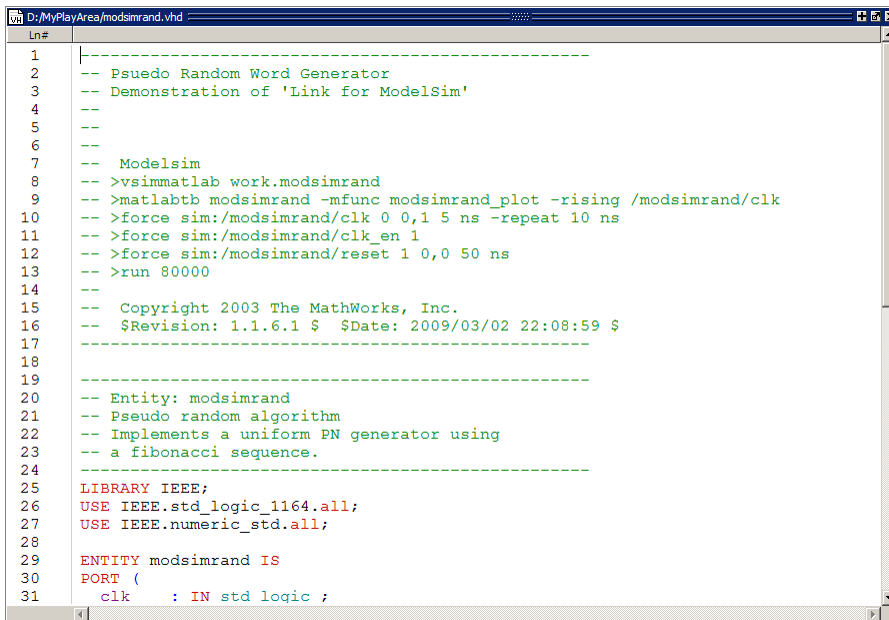

While you are viewing the file, note the following:

- The line `ENTITY modsimrand` contains the definition for the VHDL entity `modsimrand`:

```
ENTITY modsimrand IS
PORT (
    clk      : IN std_logic ;
    clk_en   : IN std_logic ;
    reset    : IN std_logic ;
    dout     : OUT std_logic_vector (31 DOWNTO 0);
END modsimrand;
```

This is the entity that will be verified in the MATLAB environment during the tutorial. Note the following:

- By default, the MATLAB server assumes that the name of the MATLAB function that verifies the entity in the MATLAB environment is the same as the entity name. You have the option of naming the MATLAB function explicitly. However, if you do not specify a name, the server expects the function name to match the entity name. In this example, the MATLAB function name is `modsimrand_plot` and does not match.
- The entity must be defined with a **PORT** clause that includes at least one port definition. Each port definition must specify a port mode (**IN**, **OUT**, or **INOUT**) and a VHDL data type that is supported by the HDL Verifier software. For a list of the supported types, see “Code HDL Modules for Verification Using MATLAB ” on page 1-5.

The entity `modsimrand` in this example is defined with three input ports `clk`, `clk_en`, and `reset` of type `STD_LOGIC` and output port `dout` of type `STD_LOGIC_VECTOR`. The output port passes simulation output data out to the MATLAB function for verification. The optional input ports receive clock and reset signals from the function. Alternatively, the input ports can receive signals from ModelSim **force** commands.

For more information on coding port entities for use with MATLAB, see “Code HDL Modules for Verification Using MATLAB ” on page 1-5.

- The remaining code for `modsimrand.vhd` defines a behavioral architecture for `modsimrand` that writes a randomly generated Fibonacci sequence to an output register when the clock experiences a rising edge.

When you are finished examining the file, close the ModelSim **edit** window.

Compile VHDL

After you create or edit your VHDL source files, compile them. As part of this tutorial, compile `modsimrand.vhd`. One way of compiling the file is to click the file name in the project workspace and select **Compile > Compile All**. An alternative is to specify `modsimrand.vhd` with the `vcom` command, as follows:

```
ModelSim> vcom modsimrand.vhd
```

If the compilation succeeds, messages appear in the command window and the compiler populates the work library with the compilation results.

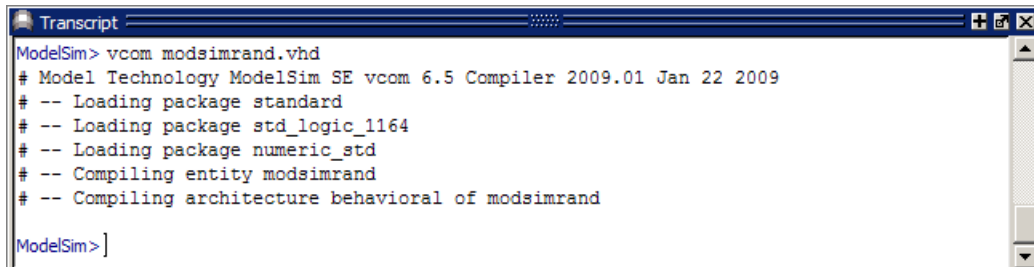

```
Transcript
ModelSim> vcom modsimrand.vhd
# Model Technology ModelSim SE vcom 6.5 Compiler 2009.01 Jan 22 2009
# -- Loading package standard
# -- Loading package std_logic_1164
# -- Loading package numeric_std
# -- Compiling entity modsimrand
# -- Compiling architecture behavioral of modsimrand
ModelSim> ]
```

Develop MATLAB Function

The HDL Verifier software verifies HDL hardware in MATLAB as a function. Typically, at this point you would create or edit a MATLAB function that meets HDL Verifier requirements. For this tutorial, you do not need to develop the MATLAB test bench function yourself. Instead, open and examine the existing file `modsimrand_plot.m`.

If you choose not to examine the HDL code at this time, skip to “Load Simulation” on page 1-46.

Note: `modsimrand_plot.m` is a lower-level component of the MATLAB Random Number Generator example. Plotting code within `modsimrand_plot.m` is not discussed in the next section. This tutorial focuses only on those parts of `modsimrand_plot.m` that are required for MATLAB to verify a VHDL model.

You can open `modsimrand_plot.m` in the MATLAB Editor. For example:

```
edit modsimrand_plot.m
```

While you are viewing the file, note the following:

- On line 1, you will find the MATLAB function name specified along with its required parameters:

```
function [iport,tnext] = modsimrand_plot(oport,tnow,portinfo)
```

This function definition is significant because it represents the communication channel between MATLAB and ModelSim. Note:

- When coding the function, you must define the function with two output parameters, `oport` and `tnext`, and three input parameters, `oport`, `tnow`, and `portinfo`. See “MATLAB Function Syntax and Function Argument Definitions” on page 8-32.
- You can use the `oport` parameter to drive input signals instead of, or in addition to, using other signal sources, such as ModelSim `force` commands. Depending on your application, you might use any combination of input sources. However, if multiple sources drive signals to a single `oport`, you will need a resolution function to handle signal contention.
- On lines 22 and 23, you will find some parameter initialization:

```
tnext = [];
oport = struct();
```

In this case, function outputs `oport` and `tnext` are initialized to empty values.

- When coding a MATLAB function for use with HDL Verifier, you need to know the types of the data that the test bench function receives from and needs to return to ModelSim and how HDL Verifier handles this data; see “Data Type Conversions” on page 8-49. This function includes the following port data type definitions and conversions:
 - The entity defined for this tutorial consists of three input ports of type `STD_LOGIC` and an output port of type `STD_LOGIC_VECTOR`.
 - Data of type `STD_LOGIC_VECTOR` consists of a column vector of characters with one bit per character.
 - The interface converts scalar data of type `STD_LOGIC` to a character that matches the character literal for the corresponding enumerated type.

On line 62, the line of code containing `oport.dout` shows how the data that a MATLAB function receives from ModelSim might need to be converted for use in the MATLAB environment:

```
ud.buffer(cyc) = mv12dec(oport.dout)
```

In this case, the function receives `STD_LOGIC_VECTOR` data on `oport`. The function `mv12dec` converts the bit vector to a decimal value that can be used in arithmetic computations. “Data Type Conversions” on page 8-49 provides a summary of the types of data conversions to consider when coding your own MATLAB functions.

- Feel free to browse through the rest of `modsimrand_plot.m`. When you are finished, go to “Load Simulation” on page 1-46.

Load Simulation

After you compile the VHDL source file, you are ready to load the model for simulation. This section explains how to load an instance of entity `modsimrand` for simulation:

- 1 Load the instance of `modsimrand` for verification. To load the instance, specify the `vsimmatlab` command as follows:

```
ModelSim> vsimmatlab modsimrand
```

The `vsimmatlab` command starts the ModelSim simulator, `vsim`, specifically for use with MATLAB. ModelSim displays a series of messages in the command window as it loads the entity's packages and architecture.

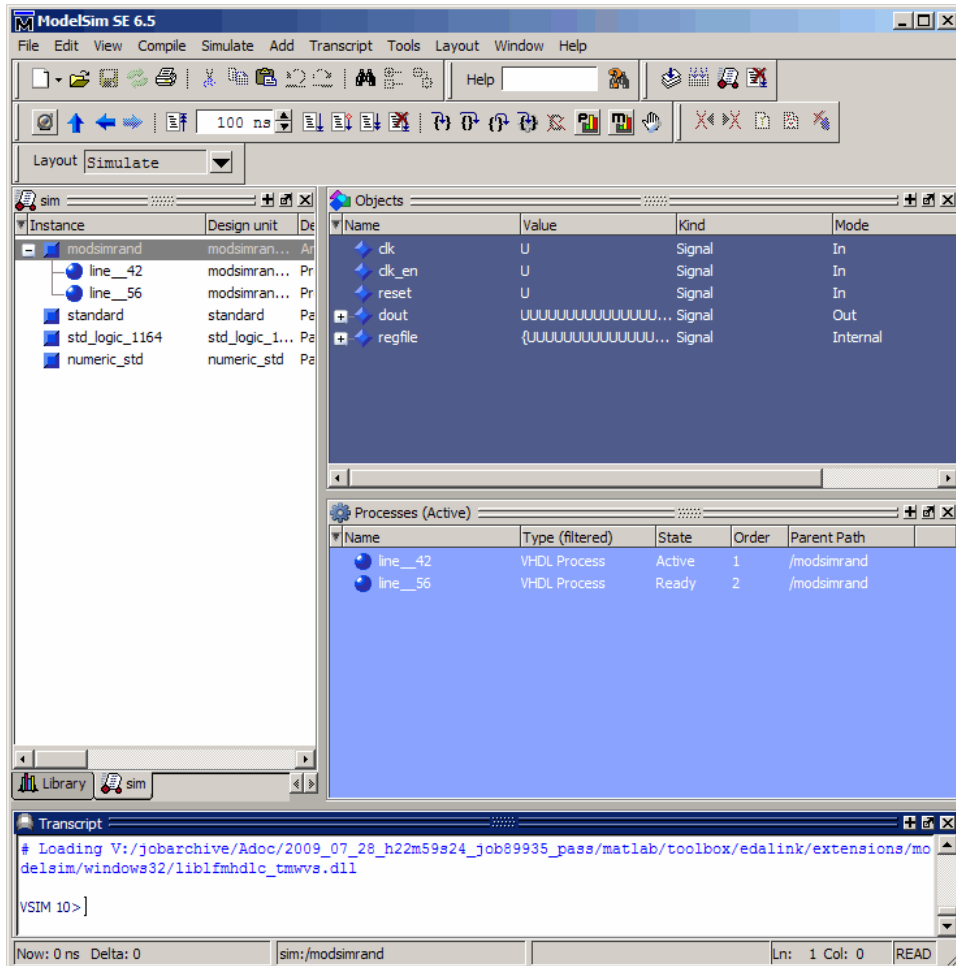

- Initialize the simulator for verifying `modsimrand` with MATLAB. You initialize ModelSim by using the HDL Verifier `matlabtb` command. This command defines the communication link and a callback to a MATLAB function that executes in MATLAB on behalf of ModelSim. In addition, the `matlabtb` command can specify parameters that control when the MATLAB function executes.

For this tutorial, enter the following `matlabtb` command:

```
> matlabtb modsimrand -mfunc modsimrand_plot -rising /modsimrand/clock -socket portnum
```

Arguments in the command line specify the following conditions:

- `modsimrand`— Specifies the VHDL module to cosimulate.
- `-mfunc modsimrand_plot`— Links an instance of the entity `modsimrand` to the MATLAB function `modsimrand_plot.m`. The argument is required because the entity name is not the same as the test bench function name.
- `-rising /modsimrand/clk`— Specifies that the test bench function be called whenever signal `/modsimrand/clk` experiences a rising edge.
- `-socketportnum`— Specifies the port number issued with or returned by the call to `hdldaemon` in “Start the MATLAB Server” on page 1-38.

- 3 Initialize clock and reset input signals. You can drive simulation input signals using several mechanisms, including ModelSim `force` commands and an `iport` parameter (see “Syntax of a Test Bench Function” on page 1-11). For now, enter the following `force` commands:

```
> force /modsimrand/clk 0 0 ns, 1 5 ns -repeat 10 ns
> force /modsimrand/clk_en 1
> force /modsimrand/reset 1 0, 0 50 ns
```

The first command forces the `clk` signal to value 0 at 0 nanoseconds and to 1 at 5 nanoseconds. After 10 nanoseconds, the cycle starts to repeat every 10 nanoseconds. The second and third `force` commands set `clk_en` to 1 and `reset` to 1 at 0 nanoseconds and to 0 at 50 nanoseconds.

The ModelSim environment is ready to run a simulation. Now, you need to set up the MATLAB function.

Run Simulation

This section explains how to start and monitor this simulation, and rerun it, if you desire. When you have completed as many simulation runs as desired, shut down the simulation as described in the next section.

Running the Simulation for the First Time

Before running the simulation for the first time, you must verify the client connection. You may also want to set breakpoints for debugging.

Perform the following steps:

- 1 Open ModelSim and MATLAB windows.
- 2 In MATLAB, verify the client connection by calling `hdldaemon` with the `'status'` option:

```
hdldaemon('status')
```

This function returns a message indicating a connection exists:

```
HDLDaemon socket server is running on port 4795 with 1 connection
```

Or

```
HDLDaemon shared memory server is running with 1 connection
```

Note: If you attempt to run the simulation before starting the `hdldaemon` in MATLAB, you will receive the following warning:

```
#ML Warn - MATLAB server not available (yet),  
The entity 'modsimrand' will not be active
```

- 3 Open `modsimrand_plot.m` in the MATLAB Editor.
- 4 Search for `oport.dout` and set a breakpoint at that line by clicking next to the line number. A red breakpoint marker will appear.
- 5 Return to ModelSim and enter the following command in the command window:

```
> run 80000
```

This command instructs ModelSim to advance the simulation 80,000 time steps (80,000 nanoseconds using the default time step period). Because you previously set a breakpoint in `modsimrand_plot.m`, however, the simulation runs in MATLAB until it reaches the breakpoint.

ModelSim is now blocked and remains blocked until you explicitly unblock it. While the simulation is blocked, note that MATLAB displays the data that ModelSim passed to the MATLAB function in the **Workspace** window.

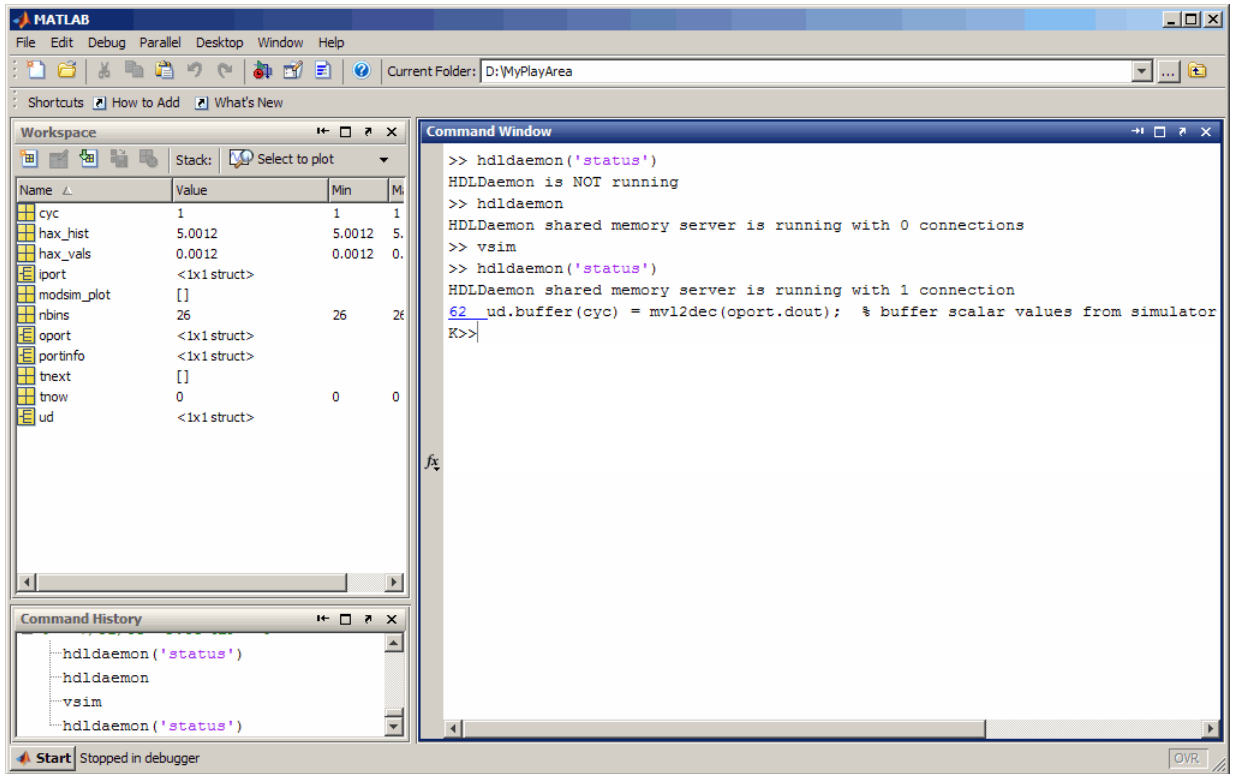

In ModelSim, an empty figure window opens. You can use this window to plot data generated by the simulation.

- 6 Examine `oport`, `portinfo`, and `tnow` by hovering over these arguments inside the MATLAB Editor. Observe that `tnow`, the current simulation time, is set to 0. Also notice that, because the simulation has reached a breakpoint during the first call to `modsimrand_plot`, the `portinfo` argument is visible in the MATLAB workspace.
- 7 Click **Continue** in the MATLAB Editor. The next time the breakpoint is reached, notice that `portinfo` no longer appears in the MATLAB workspace. The `portinfo` function does not show because it is passed in only on the first function invocation. Also note that the value of `tnow` advances from 0 to $5e-009$.
- 8 Clear the breakpoint by clicking the red breakpoint marker.

- 9 Unblock ModelSim and continue the simulation by clicking **Continue** in the MATLAB Editor.

The simulation runs to completion. As the simulation progresses, it plots generated data in a figure window. When the simulation completes, the figure window appears as shown here.

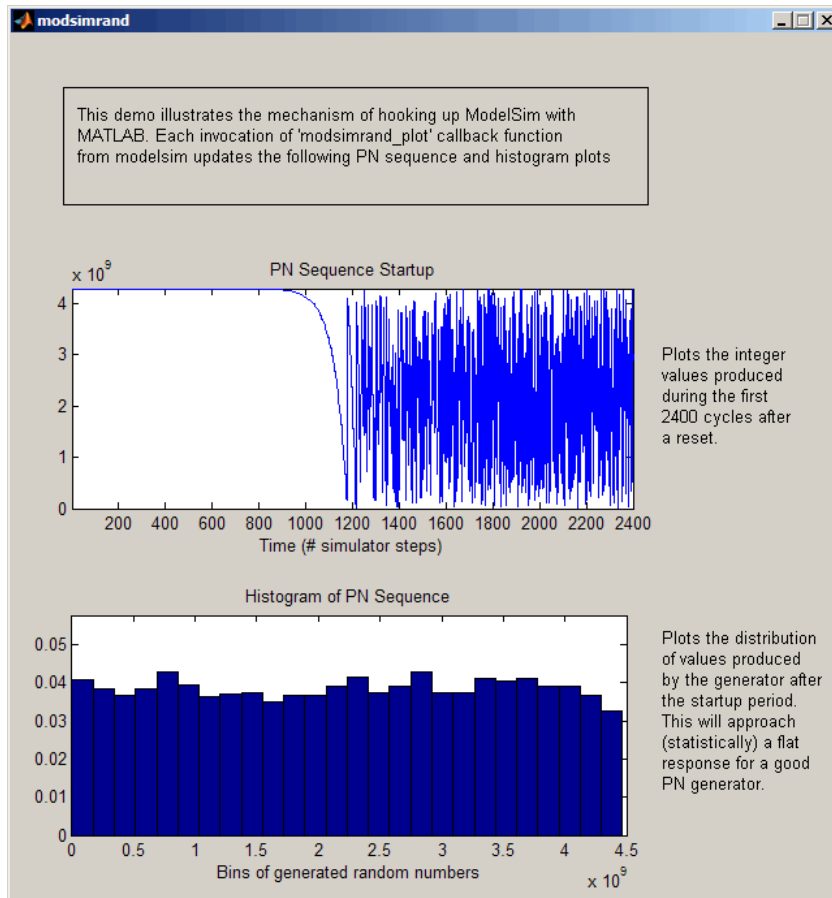

The simulation runs in MATLAB until it reaches the breakpoint that you just set. Continue the simulation/debugging session as desired.

Rerunning the Simulation

If you want to run the simulation again, you must restart the simulation in ModelSim, reinitialize the clock, and reset input signals. To do so:

- 1 Close the figure window.
- 2 Restart the simulation with the following command:

```
> restart
```

The **Restart** dialog box appears. Leave all the options enabled, and click **Restart**.

Note: The **Restart** button clears the simulation context established by a `matlabtb` command. Thus, after restarting ModelSim, you must reissue the previous command or issue a new command.

- 3 Reissue the `matlabtb` command in the HDL simulator.

```
> matlabtb modsimrand -mfunc modsimrand_plot -rising /modsimrand/clock -socket portnum
```

- 4 Open `modsimrand_plot.m` in the MATLAB Editor.
- 5 Set a breakpoint at the same line as in the previous run.
- 6 Return to ModelSim and re-enter the following commands to reinitialize clock and input signals:

```
> force /modsimrand/clock 0 0,1 5 ns -repeat 10 ns  
> force /modsimrand/clock_en 1  
> force /modsimrand/reset 1 0, 0 50 ns
```

- 7 Enter a command to start the simulation, for example:

```
> run 80000
```

Shut Down Simulation

This section explains how to shut down a simulation in an orderly way.

In ModelSim, perform the following steps:

- 1 Stop the simulation on the client side by selecting **Simulate > End Simulation** or entering the `quit` command.
- 2 Quit ModelSim.

In MATLAB, you can just quit the application, which will shut down the simulation and also close MATLAB.

To shut down the server without closing MATLAB, you have the option of calling `hdldaemon` with the `'kill'` option:

```
hdldaemon('kill')
```

The following message appears, confirming that the server was shut down:

```
HDLDaemon server was shutdown
```

Automatic Cosimulation Verification

Cosimulate the device-under-test (DUT) in ModelSim or Cadence Incisive. You can optionally include a test bench in MATLAB. To use this feature, you must have an HDL Coder™ license.

- 1 Start the MATLAB to HDL Workflow Advisor.

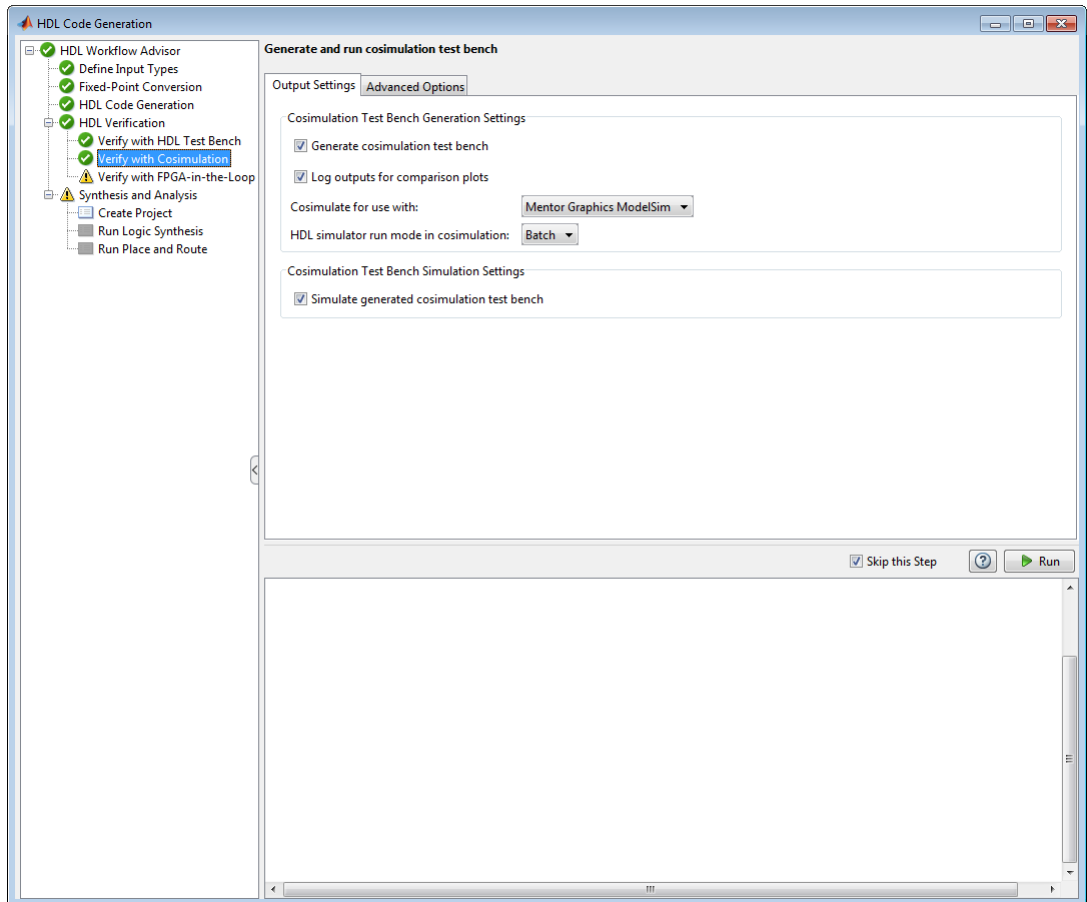

- 2 At step **HDL Verification**, click **Verify with Cosimulation**.
- 3 Select **Generate HDL test bench** to instruct HDL Coder to generate HDL test bench code from your MATLAB test script (optional).

- 4 Select **Log outputs for comparison plots** if you would like to log and plot outputs of the reference design function and HDL simulator (optional).
- 5 For **Cosimulate for use with**, select either **Mentor Graphics ModelSim** or **Cadence Incisive** as the HDL simulator you want for cosimulation.
- 6 For HDL simulator run mode in cosimulation, select **Batch** mode for non-interactive simulation. Select **GUI** mode to view waveforms.
- 7 Select **Simulate generated cosimulation test bench** to automatically verify the generated HDL code in a cosimulation test bench.
- 8 For **Advanced Options**, select and set the optional parameters according to the descriptions in the following table.

Parameter	Description
Clock high time (ns)	Specify the number of nanoseconds the clock is high.
Clock low time (ns)	Specify the number of nanoseconds the clock is low.
Hold time (ns)	Specify the hold time for input signals and forced reset signals.
Clock enable delay (in clock cycles)	Specify time (in clock cycles) between deassertion of reset and assertion of clock enable.
Reset length (in clock cycles)	Specify time (in clock cycles) between assertion and deassertion of reset.

- 9 Optionally, select **Skip this step** if you don't want to verify with cosimulation.
- 10 Click **Run**.

If you selected Batch mode, a command window appears to launch the HDL simulator and run the cosimulation. This window is closed programmatically. If you selected GUI mode, the HDL simulator is opened and left open after simulation so that you may examine the waveforms and other signal data.

If there are errors, those messages appear in the message pane. Correct any errors and click **Run**.

HDL Cosimulation Using MATLAB Component Function

- “MATLAB Function as a Component” on page 2-2
- “Create a MATLAB Component Function” on page 2-4
- “Code HDL Modules for Visualization Using MATLAB” on page 2-5
- “Create an HDL Verifier MATLAB Component Function” on page 2-10
- “Place Component Function on MATLAB Search Path” on page 2-12
- “Start Connection to HDL Simulator” on page 2-13
- “Start HDL Simulator” on page 2-15
- “Bind Component Function Calls With matlabcp” on page 2-16
- “Schedule Options for a Component Session” on page 2-20
- “Run MATLAB Component Function Simulation” on page 2-23
- “Stop Component Simulation” on page 2-30

MATLAB Function as a Component

The HDL Verifier software provides a means for visualizing HDL components within the MATLAB environment. You do so by coding an HDL model and a MATLAB function that can share data with the HDL model. This chapter discusses the programming, interfacing, and scheduling conventions for MATLAB component functions that communicate with the HDL simulator.

MATLAB component functions simulate the behavior of components in the HDL model. A stub module (providing port definitions only) in the HDL model passes its input signals to the MATLAB component function. The MATLAB component processes this data and returns the results to the outputs of the stub module. A MATLAB component typically provides some functionality (such as a filter) that is not yet implemented in the HDL code.

The following figure shows how an HDL simulator wraps around a MATLAB component function and how MATLAB communicates with the HDL simulator during a component simulation session.

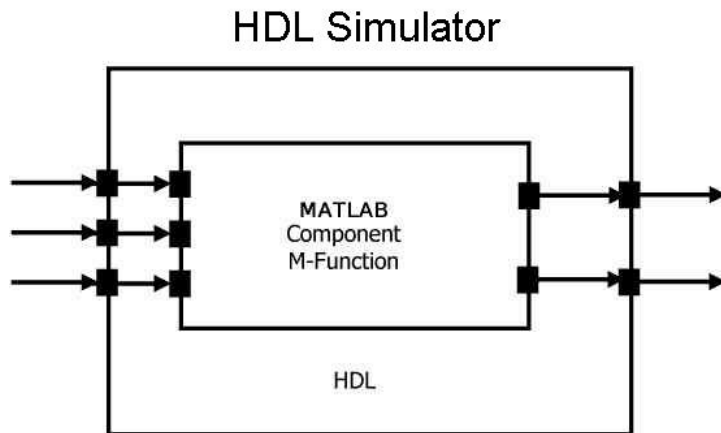

When linked with MATLAB, the HDL simulator functions as the client, with MATLAB as the server. The following figure shows a multiple-client scenario connecting to the server at TCP/IP socket port 4449.

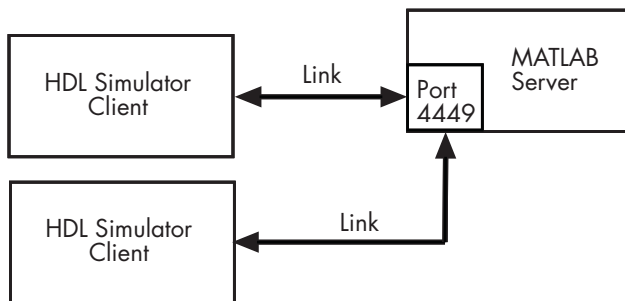

The MATLAB server can service multiple simultaneous HDL simulator sessions and HDL modules. However, you should follow recommended guidelines to help the server track the I/O associated with each module and session. The MATLAB server, which you start with the supplied MATLAB function `hdl_daemon`, waits for connection requests from instances of the HDL simulator running on the same or different computers. When the server receives a request, it executes the specified MATLAB function you have coded to perform tasks on behalf of a module in your HDL design. Parameters that you specify when you start the server indicate whether the server establishes shared memory or TCP/IP socket communication links.

Refer to “Machine Configuration Requirements” on page 8-2 for valid machine configurations.

Note: The programming, interfacing, and scheduling conventions for test bench functions and component functions are virtually identical. For the most part, the same procedures apply to both types of functions.

Create a MATLAB Component Function

The following workflow steps describe how to create a MATLAB component function for cosimulation with the HDL simulator using HDL Verifier.

- 1 Create HDL module. Compile, elaborate, and simulate model in HDL simulator . See “Code HDL Modules for Visualization Using MATLAB” on page 2-5.
- 2 Create component MATLAB function. See “Create an HDL Verifier MATLAB Component Function” on page 2-10.
- 3 Place component function on MATLAB search path. See “Place Component Function on MATLAB Search Path” on page 2-12.
- 4 Start `hdldaemon` to provide connectivity for HDL simulator. See “Start Connection to HDL Simulator” on page 2-13.
- 5 Launch HDL simulator for use with MATLAB and load HDL Verifier libraries. See “Start HDL Simulator” on page 2-15
- 6 Bind HDL instance with component function using `matlabcp`. See “Bind Component Function Calls With `matlabcp`” on page 2-16.
- 7 Add scheduling options. See “Schedule Options for a Component Session” on page 2-20.
- 8 Set breakpoints for interactive HDL debug (optional).
- 9 Run cosimulation from HDL simulator. See “Run MATLAB Component Function Simulation” on page 2-23.
- 10 Disconnect session. See “Stop Component Simulation” on page 2-30.

Code HDL Modules for Visualization Using MATLAB

In this section...

“Overview to Coding HDL Modules for Visualization with MATLAB” on page 2-5

“Choose HDL Module Name for Use with MATLAB Component Function” on page 2-5

“Specify Port Direction Modes in HDL Module for Use with Component Functions” on page 2-6

“Specify Port Data Types in HDL Modules for Use with Component Functions” on page 2-6

“Compile and Elaborate HDL Design for Use with Component Functions” on page 2-8

Overview to Coding HDL Modules for Visualization with MATLAB

The most basic element of communication in the HDL Verifier interface is the HDL module. The interface passes all data between the HDL simulator and MATLAB as port data. The HDL Verifier software works with any existing HDL module. However, when you code an HDL module that is targeted for MATLAB verification, you should consider its name, the types of data to be shared between the two environments, and the direction modes. The sections within this chapter cover these topics.

The process for coding HDL modules for MATLAB visualization is as follows:

- Choose an HDL module name.
- Specify port direction modes in HDL components.
- Specify port data types in HDL components.
- Compile and debug the HDL model.

Choose HDL Module Name for Use with MATLAB Component Function

Although not required, when naming the HDL module, consider choosing a name that also can be used as a MATLAB function name. (Generally, naming rules for VHDL or Verilog and MATLAB are compatible.) By default, HDL Verifier software assumes that an HDL module and its simulation function share the same name. See “Bind Test Bench Function Calls With `matlabtb`” on page 1-22.

For details on MATLAB function-naming guidelines, see “MATLAB Programming Tips” on files and file names in the MATLAB documentation.

Specify Port Direction Modes in HDL Module for Use with Component Functions

In your module statement, you must specify each port with a direction mode (input, output, or bidirectional). The following table defines these three modes.

Use VHDL Mode...	Use Verilog Mode...	For Ports That...
IN	input	Represent signals that can be driven by a MATLAB function
OUT	output	Represent signal values that are passed to a MATLAB function
INOUT	inout	Represent bidirectional signals that can be driven by or pass values to a MATLAB function

Specify Port Data Types in HDL Modules for Use with Component Functions

This section describes how to specify data types compatible with MATLAB for ports in your HDL modules. For details on how the HDL Verifier interface converts data types for the MATLAB environment, see “Data Type Conversions” on page 8-49.

Note: If you use unsupported types, the HDL Verifier software issues a warning and ignores the port at run time. For example, if you define your interface with five ports, one of which is a VHDL access port, at run time, then the interface displays a warning and your code sees only four ports.

Port Data Types for VHDL Entities

In your entity statement, you must define each port that you plan to test with MATLAB with a VHDL data type that is supported by the HDL Verifier software. The interface can convert scalar and array data of the following VHDL types to comparable MATLAB types:

- STD_LOGIC, STD_ULOGIC, BIT, STD_LOGIC_VECTOR, STD_ULOGIC_VECTOR, and BIT_VECTOR
- INTEGER and NATURAL
- REAL
- TIME
- Enumerated types, including user-defined enumerated types and CHARACTER

The interface also supports all subtypes and arrays of the preceding types.

Note: The HDL Verifier software does not support VHDL extended identifiers for the following components:

- Port and signal names used in cosimulation
- Enum literals when used as array indices of port and signal names used in cosimulation

However, the software does support basic identifiers for VHDL.

Port Data Types for Verilog Modules

In your module definition, you must define each port that you plan to test with MATLAB with a Verilog port data type that is supported by the HDL Verifier software. The interface can convert data of the following Verilog port types to comparable MATLAB types:

- reg
- integer
- wire

Note: HDL Verifier software does not support Verilog escaped identifiers for port and signal names used in cosimulation. However, it does support simple identifiers for Verilog.

Compile and Elaborate HDL Design for Use with Component Functions

After you create or edit your HDL source files, use the HDL simulator compiler to compile and debug the code.

Compilation for ModelSim

You have the option of invoking the compiler from menus in the ModelSim graphic interface or from the command line with the `vcom` command. The following sequence of ModelSim commands creates and maps the design library `work` and compiles the VHDL file `modsimrand.vhd`:

```
ModelSim> vlib work
ModelSim> vmap work work
ModelSim> vcom modsimrand.vhd
```

The following sequence of ModelSim commands creates and maps the design library `work` and compiles the Verilog file `test.v`:

```
ModelSim> vlib work
ModelSim> vmap work work
ModelSim> vlog test.v
```

Note: You should provide read/write access to the signals that are connecting to the MATLAB session for cosimulation. For higher performance, you want to provide access only to those signals used in cosimulation. You can check read/write access through the HDL simulator—see HDL simulator documentation for details.

Compilation for Incisive

The Cadence Incisive simulator allows for 1-step and 3-step processes for HDL compilation, elaboration, and simulation. The following Cadence Incisive simulator command compiles the Verilog file `test.v`:

```
sh> ncvlog test.v
```

The following Cadence Incisive simulator command compiles and elaborates the Verilog design `test.v`, and then loads it for simulation, in a single step:

```
sh> ncverilog +gui +access+rwc +linedebug test.v
```

The following sequence of Cadence Incisive simulator commands performs all the same processes in multiple steps:

```
sh> ncvlog -linedebug test.v
sh> ncelab -access +rwc test
sh> ncsim test
```

Note: You should provide read/write access to the signals that are connecting to the MATLAB session for cosimulation. The previous example shows how to provide read/write access to all signals in your design. For higher performance, you want to provide access only to those signals used in cosimulation. See the description of the `+access` flag to `ncoverilog` and the `-access` argument to `ncelab` for details.

For more examples, see the HDL Verifier tutorials and demos. For details on using the HDL compiler, see the simulator documentation.

Create an HDL Verifier MATLAB Component Function

In this section...
“Overview to Coding an HDL Verifier Component Function” on page 2-10
“Syntax of a Component Function” on page 2-10

Overview to Coding an HDL Verifier Component Function

Coding a MATLAB function that is to visualize an HDL module or component requires that you follow specific coding conventions. You must also understand the data type conversions that occur, and program data type conversions for operating on data and returning data to the HDL simulator.

To code a MATLAB function that is to verify an HDL module or component, perform the following steps:

- 1 Learn the syntax for a MATLAB HDL Verifier component function. See “Syntax of a Component Function” on page 2-10.
- 2 Understand how HDL Verifier software converts data from the HDL simulator for use in the MATLAB environment. See “Data Type Conversions” on page 8-49.
- 3 Choose a name for the MATLAB component function. See “Bind Component Function Calls With matlabcp” on page 2-16.
- 4 Define expected parameters in the component function definition line. See “MATLAB Function Syntax and Function Argument Definitions” on page 8-32.
- 5 Determine the types of port data being passed into the function. See “MATLAB Function Syntax and Function Argument Definitions” on page 8-32.
- 6 Extract and, if applicable to the simulation, apply information received in the `portinfo` structure. See “Gaining Access to and Applying Port Information” on page 8-35.
- 7 Convert data for manipulation in the MATLAB environment, as applicable. See “Converting HDL Data to Send to MATLAB” on page 8-49.
- 8 Convert data that needs to be returned to the HDL simulator. See “Converting Data for Return to the HDL Simulator” on page 8-53.

Syntax of a Component Function

The syntax of a MATLAB component function is

```
function [iport, tnext] = MyFunctionName(oport, tnow, portinfo)
```

The input/output arguments, `iport` and `oport`, for a MATLAB component function are the reverse of the port arguments for a MATLAB test bench function. That is, the MATLAB component function returns signal data to the *outputs* and receives data from the *inputs* of the associated HDL module.

Initialize the function outputs to empty values at the beginning of the function as in the following example:

```
tnext = [];  
oport = struct();
```

See “MATLAB Function Syntax and Function Argument Definitions” on page 8-32 for an explanation of each of the function arguments. For more information on using `tnext` and `tnow` for simulation scheduling with `matlabcp`, see “Schedule Component Functions Using the `tnext` Parameter” on page 2-21.

Place Component Function on MATLAB Search Path

In this section...
“Use MATLAB which Function to Find Component Function” on page 2-12
“Add Component Function to MATLAB Search Path” on page 2-12

Use MATLAB which Function to Find Component Function

The MATLAB function that you are associating with an HDL component must be on the MATLAB search path or reside in the current working folder (see the MATLAB `cd` function). To verify whether the function is accessible, use the MATLAB `which` function. The following call to `which` checks whether the function `MyVhdlFunction` is on the MATLAB search path, for example:

```
which MyVhdlFunction  
/work/incisive/MySym/MyVhdlFunction.m
```

If the specified function is on the search path, `which` displays the complete path to the function. If the function is not on the search path, `which` informs you that the file was not found.

Add Component Function to MATLAB Search Path

To add a MATLAB function to the MATLAB search path, open the Set Path window by clicking **File > Set Path**, or use the `addpath` command. Alternatively, for temporary access, you can change the MATLAB working folder to a desired location with the `cd` command.

Start Connection to HDL Simulator

In this section...

“Start MATLAB Server for Component Function Session” on page 2-13

“Example of Starting MATLAB Server for Component Function Session” on page 2-14

Start MATLAB Server for Component Function Session

Start the MATLAB server as follows:

- 1 Start MATLAB.
- 2 In the MATLAB Command Window, call the `hdldaemon` function with property name/property value pairs that specify whether the HDL Verifier software is to perform the following tasks:
 - Use shared memory or TCP/IP socket communication
 - Return time values in seconds or as 64-bit integers

See `hdldaemon` reference documentation for when and how to specify property name/property value pairs and for more examples of using `hdldaemon`.

The communication mode that you specify (shared memory or TCP/IP sockets) must match what you specify for the communication mode when you initialize the HDL simulator for use with a MATLAB cosimulation session using the `matlabtb` or `matlabcp` function. In addition, if you specify TCP/IP socket mode, the socket port that you specify with `hdldaemon` and `matlabtb` or `matlabcp` must match. See “TCP/IP Socket Ports” on page 8-77 for more information .

The MATLAB server can service multiple simultaneous HDL simulator modules and clients. However, your code must track the I/O associated with each entity or client.

Note: You cannot begin an HDL Verifier transaction between MATLAB and the HDL simulator from MATLAB. The MATLAB server simply responds to function call requests that it receives from the HDL simulator.

Example of Starting MATLAB Server for Component Function Session

The following command specifies using socket communication on port 4449 and a 64-bit time resolution format for the MATLAB function's output ports.

```
hdldaemon('socket', 4449, 'time', 'int64')
```

Start HDL Simulator

In this section...

“Start HDL Simulator for Component Session” on page 2-15

“Load HDL Design for Visualization” on page 2-15

Start HDL Simulator for Component Session

Start the HDL simulator directly from MATLAB by calling the HDL Verifier function `vsim` or `nclaunch`.

```
>>vsim
```

You can call `vsim` or `nclaunch` with additional parameters; see the reference pages for details.

You must make sure the HDL simulator executables — also called `vsim` (ModelSim) and `nclaunch` (Cadence Incisive) — are on the system path. See your system documentation for instruction on setting environment variables.

Linux Users Make sure the HDL simulator executable is still on the system path after the shell is launched from MATLAB. If it is not, make sure the shell startup file does not remove it from the path environment variable.

Load HDL Design for Visualization

After you start the HDL simulator from MATLAB with a call to `vsim` or `nclaunch`, load an instance of an HDL module for verification or visualization with the function `vsimmatlab` or `hdlsimmatlab`. At this point, you should have coded and compiled your HDL model. Issue the function `vsimmatlab` or `hdlsimmatlab` for each instance of an entity or module in your model that you want to cosimulate. For example (for use with Incisive):

```
hdlsimmatlab work.osc_top
```

This command loads the HDL Verifier library, opens a simulation workspace for `osc_top`, and display a series of messages in the HDL simulator command window as the simulator loads the entity (see example for remaining code).

Bind Component Function Calls With `matlabcp`

In this section...
“Invoke MATLAB Component Function Command <code>matlabcp</code> ” on page 2-16
“Bind HDL Module Component to MATLAB Component Function” on page 2-18

Invoke MATLAB Component Function Command `matlabcp`

You invoke `matlabcp` by issuing the command in the HDL simulator. See the Examples section of the `matlabcp` reference page for several examples of invoking `matlabcp`.

Be sure to follow the path specifications for MATLAB component function sessions when invoking `matlabcp`, as explained in “Specify HDL Signal/Port and Module Paths for MATLAB Component Function Cosimulation” on page 2-16.

For instructions in issuing the `matlabcp` command, see “Run MATLAB Test Bench Simulation” on page 1-29.

Specify HDL Signal/Port and Module Paths for MATLAB Component Function Cosimulation

HDL Verifier software has specific requirements for specifying HDL design hierarchy, the syntax of which is described in the following sections: one for Verilog at the top level, and one for VHDL at the top level. Do not use a file name hierarchy in place of the design hierarchy name.

The rules stated in this section apply to signal/port and module path specifications for MATLAB cosimulation sessions. Other specifications may work but the HDL Verifier software does not officially recognize nor support them.

In the following example:

```
matlabtb u_osc_filter -mfunc oscfilter
```

`u_osc_filter` is the top-level component. If you specify a subcomponent, you must follow valid module path specifications for MATLAB cosimulation sessions.

Path Specifications for MATLAB Link Sessions with Verilog Top Level

- The path specification must start with a top-level module name.

- The path specification can include "." or "/" path delimiters, but it cannot include mixed delimiters.
- The leaf module or signal must match the HDL language of the top-level module.

The following examples show valid signal and module path specifications:

```
top.port_or_sig
/top/sub/port_or_sig
top
top/sub
top.sub1.sub2
```

The following examples show *invalid* signal and module path specifications:

- `top.sub/port_or_sig`

Why this specification is invalid: You cannot use mixed delimiters.

- `:sub:port_or_sig`

:

:sub

Why this specification is invalid: When you use VHDL-specific delimiters you limit the interoperability with paths when moving between HDL simulators and between VHDL and Verilog.

Path Specifications for MATLAB Link Sessions with VHDL Top Level

- The path specification can include the top-level module name, but you do not have to include it.
- The path specification can include "." or "/" path delimiters, but it cannot include mixed delimiters.
- The leaf module or signal must match the HDL language of the top-level module.

Examples for ModelSim and Incisive Users

The following examples show valid signal and module path specifications:

```
top.port_or_sig
/sub/port_or_sig
top
top/sub
```

top.sub1.sub2

The following examples show *invalid* signal and module path specifications:

- top.sub/port_or_sig

Why this specification is invalid: You cannot use mixed delimiters.

- :sub:port_or_sig

:

:sub

Why this specification is invalid: When you use VHDL-specific delimiters you limit the interoperability with paths when moving between HDL simulators and between VHDL and Verilog.

Bind HDL Module Component to MATLAB Component Function

By default, the HDL Verifier software assumes that the name for a MATLAB function matches the name of the HDL module that the function verifies. When you create a test bench or component function that has a different name than the design under test, you must associate the design with the MATLAB function using the `-mfunc` argument to `matlabtb`. This argument associates the HDL module instance to a MATLAB function that has a different name from the HDL instance.

For more information on the `-mfunc` argument and for a full list of `matlabtb` parameters, see the `matlabtb` function reference.

For details on MATLAB function naming guidelines, see "MATLAB Programming Tips" on files and file names in the MATLAB documentation.

Example of Binding Test Bench and Component Function Calls

In this first example, you form an association between the `inverter_v1` component and the MATLAB test bench function `inverter_tb` by invoking the function `matlabtb` with the `-mfunc` argument when you set up the simulation.

```
matlabtb inverter_v1 -mfunc inverter_tb
```

The `matlabtb` command instructs the HDL simulator to call back the `inverter_tb` function when `inverter_v1` executes in the simulation.

In this second example, you bind the model `osc_top.u_osc_filter` to the component function `oscfilter`:

```
matlabcp osc_top.u_osc_filter -mfunc oscfilter
```

When the HDL simulator calls the `oscfilter` callback, the function knows to operate on the model `osc_top.u_osc_filter`.

Schedule Options for a Component Session

In this section...

“About Scheduling Options for Component Sessions” on page 2-20

“Schedule Component Session Using `matlabcp` Arguments” on page 2-20

“Schedule Component Functions Using the `tnext` Parameter” on page 2-21

About Scheduling Options for Component Sessions

There are two ways to schedule the invocation of a MATLAB function:

- Using the arguments to the HDL Verifier function `matlabtb` or `matlabcp`
- Inside the MATLAB function using the `tnext` parameter

The two types of scheduling are not mutually exclusive. You can combine the `matlabtb` or `matlabcp` timing arguments and the `tnext` parameter of a MATLAB function to schedule test bench or component session callbacks.

Schedule Component Session Using `matlabcp` Arguments

By default, the HDL Verifier software invokes a MATLAB test bench or component function once (at the time that you make the call to `matlabtb/matlabcp`). If you want to apply more control, and execute the MATLAB function more than once, use the command scheduling options. With these options, you can specify when and how often the HDL Verifier software invokes the relevant MATLAB function. If applicable, modify the function or specify timing arguments when you begin a MATLAB test bench or component function session with the `matlabtb/matlabcp` function.

You can schedule a MATLAB test bench or component function to execute using the command arguments under any of the following conditions:

- **Discrete time values**—Based on time specifications that can also include repeat intervals and a stop time
- **Rising edge**—When a specified signal experiences a rising edge
 - VHDL: Rising edge is {0 or L} to {1 or H}.
 - Verilog: Rising edge is the transition from 0 to x, z, or 1, and from x or z to 1.

- **Falling edge**—When a specified signal experiences a falling edge
 - VHDL: Falling edge is {1 or H} to {0 or L}.
 - Verilog: Falling edge is the transition from 1 to x, z, or 0, and from x or z to 0.
- **Signal state change**—When a specified signal changes state, based on a list using the `-sensitivity` argument to `matlabtb`.

Schedule Component Functions Using the `tnext` Parameter

You can control the callback timing of a MATLAB function by using that function's `tnext` parameter. This parameter passes a time value to the HDL simulator, and the value gets added to the simulation schedule for that function. If the function returns a null value (`[]`), the software does not add any new entries to the schedule.

You can set the value of `tnext` to a value of type `double` or `int64`. Specify `double` to express the callback time in seconds. For example, to schedule a callback in 1 ns, specify:

```
tnext = 1e-9
```

Specify `int64` to convert to an integer multiple of the current HDL simulator time resolution limit. For example: if the HDL simulator time precision is 1 ns, to schedule a callback at 100 ns, specify:

```
tnext=int64(100)
```

Note: The `tnext` parameter represents time from the start of the simulation. Therefore, `tnext` must always be greater than `tnow`. If it is less, the software does not schedule a callback.

For more information on `tnext` and the function prototype, see “MATLAB Function Syntax and Function Argument Definitions” on page 8-32.

Examples of Scheduling with `tnext`

In this first example, each time the HDL simulator calls the test bench function (via HDL Verifier), `tnext` schedules the next callback to the MATLAB function for 1 ns later, relative to the current simulation time:

```
tnext = [];
```

```
.  
.   
.   
tnext = tnow+1e-9;
```

Using `tnext` you can dynamically decide the callback scheduling based on criteria specific to the operation of the test bench. For example, you can decide to stop scheduling callbacks when a data signal has a certain value:

```
    if qsum == 17,  
        qsum = 0;  
        disp('done');  
        tnext = []; % suspend callbacks  
        testisdone = 1;  
        return;  
    end
```

This next example demonstrates scheduling a component session using `tnext`. In the Oscillator example, the `oscfilter` function calculates a time interval at which the HDL simulator calls the callbacks. The component function calculates this interval on the first call to `oscfilter` and stores the result in the variable `fastestrate`. The variable `fastestrate` represents the sample period of the fastest oversampling rate supported by the filter. The function derives this rate from a base sampling period of 80 ns.

The following assignment statement sets the timing parameter `tnext`. This parameter schedules the next callback to the MATLAB component function, relative to the current simulation time (`tnow`).

```
tnext = tnow + fastestrate;
```

The function returns a new value for `tnext` each time the HDL simulator calls the function.

Run MATLAB Component Function Simulation

In this section...

- “Process for Running MATLAB Component Function Cosimulation” on page 2-23
- “Check MATLAB Server's Link Status for Component Cosimulation” on page 2-23
- “Run Component Function Cosimulation” on page 2-24
- “Apply Stimuli to Component Function with force Command” on page 2-27
- “Restart Component Simulation” on page 2-28

Process for Running MATLAB Component Function Cosimulation

To start and control the execution of a simulation in the MATLAB environment, perform the following steps:

- 1 “Check MATLAB Server's Link Status for Test Bench Cosimulation” on page 1-29
- 2 “Run MATLAB Test Bench Simulation” on page 1-29
- 3 “Apply Stimuli to Test Bench Session with force Command” on page 1-33
- 4 “Restart Test Bench Simulation” on page 1-35 (if applicable).

Check MATLAB Server's Link Status for Component Cosimulation

The first step to starting an HDL simulator and MATLAB test bench or component function session is to check the link status of the MATLAB server. Is the server running? If the server is running, what mode of communication and, if applicable, what TCP/IP socket port is the server using for its links? You can retrieve this information by using the MATLAB function `hdldaemon` with the `'status'` option. For example:

```
hdldaemon('status')
```

The function displays a message that indicates whether the server is running and, if it is running, the number of connections it is handling. For example:

```
HDLDaemon socket server is running on port 4449 with 0 connections
```

If the server is not running, the message reads

```
HDLDaemon is NOT running
```

See the Options: Inputs section in the `hdldaemon` reference documentation for information on determining the mode of communication and the TCP/IP socket in use.

Run Component Function Cosimulation

You can run a cosimulation session using both the MATLAB and HDL simulator GUIs (typical) or, to reduce memory demand, you can run the cosimulation using the command line interface (CLI) or in batch mode.

- “Cosimulation with MATLAB Using the HDL Simulator GUI” on page 1-30
- “Cosimulation with MATLAB Using the Command Line Interface (CLI)” on page 1-32
- “Cosimulation with MATLAB Using Batch Mode” on page 1-33

Cosimulation with MATLAB Using the HDL Simulator GUI

These steps describe a typical sequence for running a simulation interactively from the main HDL simulator window:

- 1 Set breakpoints in the HDL and MATLAB code to verify and analyze simulation progress.

How you set breakpoints in the HDL simulator will vary depending on what simulator application you are using.

In MATLAB, there are several ways you can set breakpoints; for example, by using the **Set/Clear Breakpoint** button on the toolbar.

- 2 Issue `matlabtb` command at the HDL simulator prompt.

When you begin a specific test bench or component session, you specify parameters that identify the following information:

- The mode and, if applicable, TCP/IP data for connecting to a MATLAB server (see `matlabtb` reference)
- The MATLAB function that is associated with and executes on behalf of the HDL instance. See “Bind HDL Module Component to MATLAB Test Bench Function” on page 1-24.
- Timing specifications and other control data that specifies when the module's MATLAB function is to be called. See “Schedule Options for a Test Bench Session” on page 1-26.

For example:

```
hdlsim> matlabtb osc_top -sensitivity /osc_top/sine_out
        -socket 4448 -mfunc hosctb
```

- 3 Start the simulation by entering the HDL simulator `run` command.

The `run` command offers a variety of options for applying control over how a simulation runs (refer to your HDL simulator documentation for details). For example, you can specify that a simulation run for several time steps.

The following command instructs the HDL simulator to run the loaded simulation for 50000 time steps:

```
run 50000
```

- 4 Step through the simulation and examine values.

How you step through the simulation in the HDL simulator will vary depending on what simulator application you are using.

In MATLAB, there are several ways you can step through code; for example, by clicking the **Step** toolbar button.

- 5 When you block execution of the MATLAB function, the HDL simulator also blocks and remains blocked until you clear all breakpoints in the function's code.
- 6 Resume the simulation, as desired.

How you resume the simulation in the HDL simulator will vary depending on what simulator application you are using.

In MATLAB, there are several ways you can resume the simulation; for example, by clicking the **Continue** toolbar button.

The following HDL simulator command resumes a simulation:

```
run -continue
```

For more information on HDL simulator and MATLAB debugging features, see the HDL simulator documentation and MATLAB online help or documentation.

Cosimulation with MATLAB Using the Command Line Interface (CLI)

Running your cosimulation session using the command-line interface allows you to interact with the HDL simulator during cosimulation, which can be helpful for debugging.

To use the CLI, specify "CLI" as the property value for the `run` mode parameter of the HDL Verifier HDL simulator launch command.

The Tcl command you build to pass to the HDL simulator launch command must contain the run command or no cosimulation will take place.

Caution Close the terminal window by entering `quit -f` at the command prompt. Do not close the terminal window by clicking the "X" in the upper right-hand corner. This causes a memory-type error to be issued from the system. This is not a bug with HDL Verifier but just the way the HDL simulator behaves in this context.

You can type CTRL+C to interrupt and terminate the simulation in the HDL simulator but this action also causes the memory-type error to be displayed.

Specify CLI mode with `nclaunch` (Cadence Incisive)

Issue the `nclaunch` command with "CLI" as the `runmode` property value, as follows (example entered into the MATLAB editor):

```
tclcmd = { ['cd ',projdir],...
          ['exec ncvtlog ' srcfile],...
          'exec ncelab -access +wc lowpass_filter',...
          ['hdlsimmatlab -gui lowpass_filter ', ...
          ' -input "{@matlabtb lowpass_filter 10ns -repeat 10ns ...
-mfunc filter_tb_incisive}"',...
          ' -input "{@force lowpass_filter.clk_enable 1 -after 0ns}"',...
          ' -input "{@force lowpass_filter.reset 1 -after 0ns 0 -after 22ns}"',...
          ' -input "{@force lowpass_filter.clk 1 -after 0ns 0 -after 5ns ...
-repeat 10ns}"',...
          ' -input "{@deposit lowpass_filter.filter_in 0}"',...
        ]};

nclaunch('tclstart',tclcmd,'runmode','CLI');
```

Specify CLI mode with `vsim` (Mentor Graphics ModelSim)

Issue the `vsim` command with "CLI" as the `runmode` property value, as follows (example entered into the MATLAB editor):

```
tclcmd = { ['cd ',unixprojdir],...
          'vlib work',... %create library (if applicable)
          'force /osc_top/clk_enable 1 0',...
          'force /osc_top/reset 1 0, 0 120 ns',...
          'force /osc_top/clk 1 0 ns, 0 40 ns -r 80ns',...
        };

vsim('tclstart',tclcmd,'runmode','CLI');
```

Cosimulation with MATLAB Using Batch Mode

Running your cosimulation session in batch mode allows you to keep the process in the background, reducing demand on memory by disengaging the GUI.

To use the batch mode, specify "Batch" as the property value for the run mode parameter of the HDL Verifier HDL simulator launch command. After you issue the HDL Verifier HDL simulator launch command with batch mode specified, start the simulation in Simulink. To stop the HDL simulator before the simulation is completed, issue the `breakHdlSim` command.

Specify Batch mode with `nclaunch` (Cadence Incisive)

Issue the `nclaunch` command with "Batch" as the `runmode` parameter, as follows:

```
nclaunch('tclstart',manchestercmds,'runmode','Batch')
```

You can also set `runmode` to 'Batch with Xterm', which starts the HDL simulator in the background but shows the session in an Xterm.

Specify Batch mode with `vsim` (Mentor Graphics ModelSim)

On Windows, specifying batch mode causes ModelSim to be run in a non-interactive command window. On Linux, specifying batch mode causes ModelSim to be run in the background with no window.

Issue the `vsim` command with 'Batch' as the `runmode` parameter, as follows:

```
>> vsim('tclstart',manchestercmds,'runmode','Batch')
```

Apply Stimuli to Component Function with `force` Command

After you establish a connection between the HDL simulator and MATLAB, you can then apply stimuli to the test bench or component cosimulation environment. One way of applying stimuli is through the `iport` parameter of the linked MATLAB function. This parameter forces signal values by deposit.

Other ways to apply stimuli include issuing `force` commands in the HDL simulator main window (for ModelSim, you can also use the **Edit > Clock** option in the **ModelSim Signals** window).

For example, consider the following sequence of `force` commands:

- Incisive

```
force osc_top.clk_enable 1 -after 0ns  
force osc_top.reset 0 -after 0ns 1 -after 40ns 0 -after 120ns  
force osc_top.clk 1 -after 0ns 0 -after 40ns -repeat 80ns
```

- ModelSim

```
VSIM n> force clk 0 0 ns, 1 5 ns -repeat 10 ns
VSIM n> force clk_en 1 0
VSIM n> force reset 0 0
```

These commands drive the following signals:

- The `clk` signal to 0 at 0 nanoseconds after the current simulation time and to 1 at 5 nanoseconds after the current HDL simulation time. This cycle repeats starting at 10 nanoseconds after the current simulation time, causing transitions from 1 to 0 and 0 to 1 every 5 nanoseconds, as the following diagram shows.



For example,

```
force /foobar/clk 0 0, 1 5 -repeat 10
```

- The `clk_en` signal to 1 at 0 nanoseconds after the current simulation time.
- The `reset` signal to 0 at 0 nanoseconds after the current simulation time.

Incisive Users: Using HDL to Code Clock Signals Instead of the force Command

You should consider using HDL to code clock signals as `force` is a lower performance solution in the current version of Cadence Incisive simulators.

The following are ways that a periodic force might be introduced:

- Via the Clock pane in the HDL Cosimulation block
- Via pre/post Tcl commands in the HDL Cosimulation block
- Via a user-input Tcl script to `ncsim`

All three approaches may lead to performance degradation.

Restart Component Simulation

Because the HDL simulator issues the service requests during a MATLAB cosimulation session, you must restart the session from the HDL simulator. To restart a session, perform the following steps:

- 1** Make the HDL simulator your active window, if your input focus was not already set to that application.
- 2** Reload HDL design elements and reset the simulation time to zero.
- 3** Reissue the `matlabtb` or `matlabcp` command.

Note: To restart a simulation that is in progress, issue a break command and end the current simulation session before restarting a new session.

Stop Component Simulation

When you are ready to stop a test bench or component session, it is best to do so in an orderly way to avoid possible corruption of files and to see that all application tasks shut down cleanly. You should stop a session as follows:

- 1 Make the HDL simulator your active window, if your input focus was not already set to that application.
- 2 Halt the simulation. You must quit the simulation at the HDL simulator side or MATLAB may hang until the simulator is quit.
- 3 Close your project.
- 4 Exit the HDL simulator, if you are finished with the application.
- 5 Quit MATLAB, if you are finished with the application. If you want to shut down the server manually, stop the server by calling `hdldaemon` with the 'kill' option:

```
hdldaemon('kill')
```

For more information on closing HDL simulator sessions, see the HDL simulator documentation.

HDL Cosimulation Using MATLAB System Object

- “Create a MATLAB System Object” on page 3-2
- “Verify Viterbi Decoder Using MATLAB System Object and Mentor Graphics ModelSim” on page 3-3

Create a MATLAB System Object

You can verify HDL modules using the HDL Cosimulation System object. You can use the System object as a test bench or you can use it to represent a component still under design.

The easiest way to create a test bench System object is to use the HDL Cosimulation Wizard with existing HDL code. You can also create an HDL Cosimulation System object manually.

You can find out more about the HDL Cosimulation Wizard and creating System objects within these topics:

- For an example of how to use the HDL Cosimulation System object, see “Verify Viterbi Decoder Using MATLAB System Object and Mentor Graphics ModelSim” on page 3-3.
- For an example of converting existing HDL code to a System object test bench, see “Import HDL Code for Cosimulation” on page 7-2.
- For general information about how to use System objects, see “System Design and Simulation in MATLAB”

See Also

`hdlverifier.HDLCosimulation`

Verify Viterbi Decoder Using MATLAB System Object and Mentor Graphics ModelSim

This example shows you how to use MATLAB® System objects and Mentor Graphics® ModelSim® to cosimulate a Viterbi decoder implemented in VHDL.

Set Simulation Parameters and Instantiate Communication System Objects

The following code sets up the simulation parameters and instantiates the system objects that represent the channel encoder, BPSK modulator, AWGN channel, BPSK demodulator, and error rate calculator. Those objects comprise the system around the Viterbi decoder and can be thought of as the test bed for the Viterbi HDL implementation.

```
EsNo = 0; % Energy per symbol to noise power spectrum density ratio in dB
FrameSize = 1024; % Number of bits in each frame

% Convolution Encoder
hConEnc = comm.ConvolutionalEncoder;
% BPSK Modulator
hMod = comm.BPSKModulator;
% AWGN channel
hChan = comm.AWGNChannel('NoiseMethod', ...
    'Signal to noise ratio (Es/No)',...
    'SamplesPerSymbol',1,...
    'EsNo',EsNo);
% BPSK demodulator
hDemod = comm.BPSKDemodulator('DecisionMethod','Log-likelihood ratio',...
    'Variance',0.5*10^(-EsNo/10));
% Error Rate Calculator
hError = comm.ErrorRate('ComputationDelay',100,'ReceiveDelay',58);
```

Instantiate the Cosimulation System Object

The `hdlcosim` function returns an HDL cosimulation System object, which represents the HDL implementation of the Viterbi decoder in this simulation system.

```
hDec = hdlcosim('InputSignals', {'/viterbi_block/In1','/viterbi_block/In2'}, ...
    'OutputSignals', {'/viterbi_block/Out1'}, ...
    'OutputSigned', false, ...
    'OutputFractionLengths', 0, ...
    'TCLPreSimulationCommand', 'force /viterbi_block/clock_enable 1 0; for
```

```
'TCLPostSimulationCommand', 'echo "done";', ...  
'PreRunTime', {10,'ns'}, ...  
'Connection', {'Shared'}, ...  
'SampleTime', {10,'ns'});
```

Launch HDL Simulator

The `vsim` command launches ModelSim. The launched ModelSim session compiles the HDL design and loads the HDL simulation. You are ready to perform cosimulation when the HDL simulation is fully loaded in ModelSim.

```
disp('Waiting for HDL simulator to launch ...');  
vsim('tclstart',viterbi_tclcmds_modelsim('vsimmatlabsysobj'));  
Timeout=450;  
processid = pingHdlSim(Timeout);  
% Check if Modelsim is ready for Cosimulation.  
assert(ischar(processid),['Timeout: Modelsim took more than ', num2str(Timeout), ' seconds']);  
disp('Ready for cosimulation ...');
```

Run Cosimulation

This example simulates the BPSK communication system in MATLAB incorporating the Viterbi decoder HDL implementation via the cosimulation System object. This section of the code calls the processing loop to process the data frame-by-frame with 1024 bits in each data frame.

```
for counter = 1:20480/FrameSize  
    data = randi([0 1],FrameSize,1);  
    encodedData = step(hConEnc, data);  
    modSignal = step(hMod, encodedData);  
    receivedSignal = step(hChan, modSignal);  
    demodSignalSD = step(hDemod, receivedSignal);  
    quantizedValue = fi(4-demodSignalSD,0,3,0);  
    input1 = quantizedValue(1:2:2*FrameSize);  
    input2 = quantizedValue(2:2:2*FrameSize);  
    receivedBits = step(hDec,input1, input2);  
    errors = step(hError, data, double(receivedBits));  
end
```

Display the Bit-Error Rate

The Bit-Error Rate is displayed for the Viterbi decoder.

```
sprintf('Bit Error Rate is %d\n',errors(1))
```

Destroy Cosimulation System Object to Release HDL Simulator

The HDL simulator is unblocked when the HDL cosimulation system object is destroyed in MATLAB. Close the ModelSim session manually.

```
clear hDec;
```

```
% This concludes the "Verifying Viterbi Decoder Using MATLAB System Object  
% and ModelSim" example.
```

Simulink Test Bench for HDL Component

- “Simulink as a Test Bench” on page 4-2
- “Simulink Test Bench Cosimulation” on page 4-7
- “Create Simulink Model for Test Bench Cosimulation” on page 4-8
- “Code an HDL Component” on page 4-9
- “Start HDL Simulator” on page 4-12
- “Add HDL Cosimulation Block to Model” on page 4-14
- “Define HDL Cosimulation Block Interface” on page 4-16
- “Run a Test Bench Cosimulation Session” on page 4-42
- “Verify HDL Model with Simulink Test Bench” on page 4-47
- “Test Bench Automatic Verification with Simulink” on page 4-65

Simulink as a Test Bench

In this section...

“Communications During Test Bench Cosimulation” on page 4-2

“HDL Cosimulation Block Features for Test Bench Simulation” on page 4-5

Communications During Test Bench Cosimulation

When you link the HDL simulator with a Simulink application, the simulator functions as the server, as shown in the following figure.

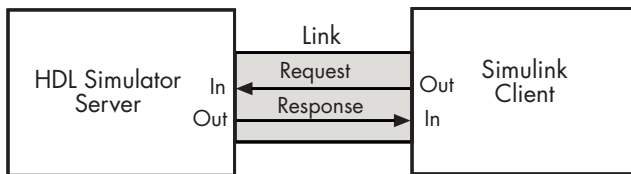

In this case, the HDL simulator responds to simulation requests it receives from cosimulation blocks in a Simulink model. You begin a cosimulation session from Simulink. After a session is started, you can use Simulink and the HDL simulator to monitor simulation progress and results. For example, you might add signals to a wave window to monitor simulation timing diagrams.

As the following figure shows, multiple cosimulation blocks in a Simulink model can request the service of multiple instances of the HDL simulator, using unique TCP/IP socket ports.

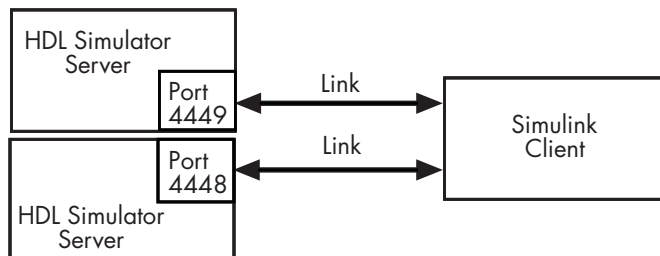

When you link the HDL simulator with a Simulink application, the simulator functions as the server. Using the HDL Verifier communications interface, an HDL Cosimulation block cosimulates a hardware component by applying input signals to and reading output signals from an HDL model under simulation in the HDL simulator.

This figure shows a sample Simulink model that includes an HDL Cosimulation block. The connection is using shared memory.

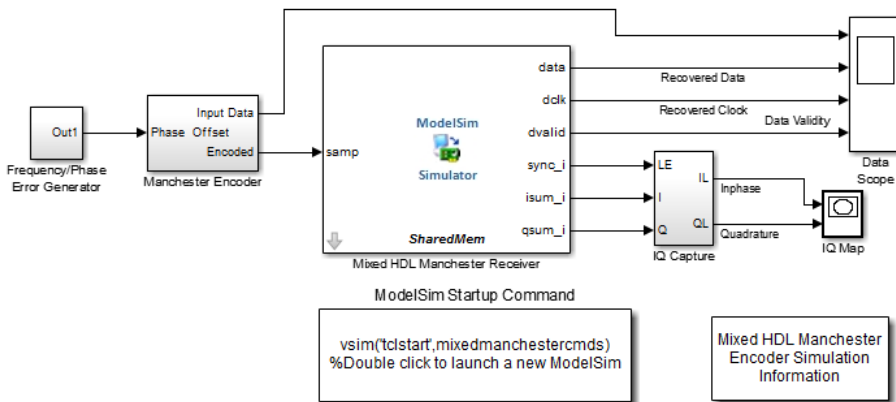

Copyright 2008-2009 The MathWorks, Inc.

The HDL Cosimulation block models a Manchester receiver that is coded in HDL. Other blocks and subsystems in the model include the following:

- Frequency Error Range block, Frequency Error Slider block, and Phase Event block
- Manchester encoder subsystem
- Data alignment subsystem
- Inphase/Quadrature (I/Q) capture subsystem
- Error Rate Calculation block from the Communications System Toolbox™ software
- Bit Errors block
- Data Scope block
- Constellation Diagram block from the Communications System Toolbox software

For information on getting started with Simulink software, see the Simulink online help or documentation.

How Simulink Drives Cosimulation Signals

Although you can bind the output ports of an HDL `Cosimulation` block to any signal in an HDL model hierarchy, you must use some caution when connecting signals to input ports. You want to verify that the signal you are binding to does not have other drivers. If it does, use resolved logic types; otherwise you may get unpredictable results.

If you need to use a signal that has multiple drivers and it is resolved (for example, it is of VHDL type `STD_LOGIC`), Simulink applies the resolution function at each time step defined by the signal's Simulink sample rate. Depending on the other drivers, the Simulink value may or may not get applied. Furthermore, Simulink has no control over signal changes that occur between its sample times.

Note: Verify that signals used in cosimulation have read/write access. You can check read/write access through the HDL simulator—see HDL simulator documentation for details.

This rule applies to all signals on the **Ports**, **Clocks**, and **Simulation** panes and to signals added to the model in any other manner.

Multirate Signals During Test Bench Cosimulation

HDL Verifier software supports the use of multirate signals, signals that are sampled or updated at different rates, in a single HDL `Cosimulation` block. An HDL `Cosimulation` block exchanges data for each signal at the Simulink sample rate for that signal. For input signals, an HDL `Cosimulation` block accepts and honors all signal rates.

The HDL `Cosimulation` block also lets you specify an independent sample time for each output port. You must explicitly set the sample time for each output port, or accept the default. Using this setting lets you control the rate at which Simulink updates an output port by reading the corresponding signal from the HDL simulator.

Continuous Time Signals

Use the Simulink `Zero-Order Hold` block to apply a zero-order hold (ZOH) on continuous signals that are driven into an HDL `Cosimulation` block.

HDL Cosimulation Block Features for Test Bench Simulation

The HDL Verifier HDL Cosimulation Block links hardware components that are concurrently simulating in the HDL simulator to the rest of a Simulink model.

You can link Simulink and the HDL simulator in two possible ways:

- As a single HDL Cosimulation block fitted into the framework of a larger system-oriented Simulink model.
- As a Simulink model made up of a collection of HDL Cosimulation blocks, each representing a specific hardware component.

The block mask contains panels for entering port and signal information, setting communication modes, adding clocks (Incisive and ModelSim only), specifying pre- and post-simulation Tcl commands (Incisive and ModelSim only), and defining the timing relationship.

After you code one of your model's components in VHDL or Verilog and simulate it in the HDL simulator environment, you integrate the HDL representation into your Simulink model as an HDL Cosimulation block. There is one block for each supported HDL simulator. These blocks are located in the Simulink Library, within the HDL Verifier block library. As an example, the block for use with Mentor Graphics® ModelSim is shown in the next figure.

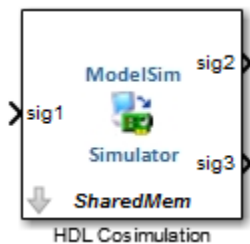

You configure an HDL `Cosimulation` block by specifying values for parameters in a block parameters dialog box. The HDL `Cosimulation` block parameters dialog box consists of tabbed panes that specify the following information:

- **Ports Pane:** Block input and output ports that correspond to signals, including internal signals, of your HDL design, and an output sample time.
- **Connection Pane:** Type of communication and related settings to be used for exchanging data between simulators.

- **Timescales Pane:** The timing relationship between Simulink software and the HDL simulator.
- **Clocks Pane** (Incisive and ModelSim only): Optional rising-edge and falling-edge clocks to apply to your model.
- **Simulation Pane** (Incisive and ModelSim only): Tcl commands to run before and after a simulation.

For more detail on each of these panes, see the [HDL Cosimulation](#) reference page.

Simulink Test Bench Cosimulation

The following workflow steps describe how to cosimulate an HDL design using Simulink software as a test bench.

- 1** Create Simulink model. See “Create Simulink Model for Test Bench Cosimulation” on page 4-8.
- 2** Code HDL module. Compile, elaborate, and simulate model in HDL simulator. See “Code an HDL Component” on page 4-9.
- 3** Start HDL simulator for use with MATLAB and Simulink and load HDL Verifier libraries. See “Start HDL Simulator” on page 4-12
- 4** Add HDL Cosimulation block. See “Add HDL Cosimulation Block to Model” on page 4-14.
- 5** Define HDL Cosimulation block interface. See “Define HDL Cosimulation Block Interface” on page 4-16.
- 6** Set breakpoints for interactive HDL debug (optional).
- 7** Start simulation in HDL simulator. See “Run a Test Bench Cosimulation Session” on page 4-42.

Create Simulink Model for Test Bench Cosimulation

In this section...
“Create Simulink Model” on page 4-8
“Run Test Bench Hardware Model in Simulink” on page 4-8
“Add Value Change Dump (VCD) File (Optional)” on page 4-8

Create Simulink Model

Create a Simulink test bench model by adding Simulink blocks from the Simulink Block libraries. For help with creating a Simulink model, see the Simulink documentation.

Run Test Bench Hardware Model in Simulink

If you design a Simulink model first, run and test your model thoroughly before replacing or adding hardware model components as HDL Verifier Cosimulation blocks.

Add Value Change Dump (VCD) File (Optional)

You might want to add a VCD file to log changes to variable values during a simulation session. See “Add a Value Change Dump (VCD) File” on page 6-2 for instructions on adding the To VCD File block.

Code an HDL Component

In this section...

“Overview to Coding HDL Components for Simulink Test Bench Sessions” on page 4-9

“Specify Port Direction Modes in the HDL Component for Test Bench Use” on page 4-9

“Specify Port Data Types in the HDL Component for Test Bench Use” on page 4-9

“Compile and Elaborate HDL Design for Test Bench Use” on page 4-11

Overview to Coding HDL Components for Simulink Test Bench Sessions

The HDL Verifier interface passes all data between the HDL simulator and Simulink as port data. The HDL Verifier software works with any existing HDL module. However, when you code an HDL module that is targeted for Simulink verification, you should consider the types of data to be shared between the two environments and the direction modes.

Specify Port Direction Modes in the HDL Component for Test Bench Use

In your module statement, you must specify each port with a direction mode (input, output, or bidirectional). The following table defines these three modes.

Use VHDL Mode...	Use Verilog Mode...	For Ports That...
IN	input	Represent signals that can be driven by a MATLAB function
OUT	output	Represent signal values that are passed to a MATLAB function
INOUT	inout	Represent bidirectional signals that can be driven by or pass values to a MATLAB function

Specify Port Data Types in the HDL Component for Test Bench Use

In your module definition, you must define each port that you plan to test with MATLAB with a Verilog port data type that is supported by the HDL Verifier software. The

interface can convert data of the following Verilog port types to comparable MATLAB types:

- reg
- integer
- wire

Note: HDL Verifier software does not support Verilog escaped identifiers for port and signal names used in cosimulation. However, it does support simple identifiers for Verilog.

Port Data Types for VHDL Entities

In your entity statement, you must define each port that you plan to test with MATLAB with a VHDL data type that is supported by the HDL Verifier software. The interface can convert scalar and array data of the following VHDL types to comparable MATLAB types:

- STD_LOGIC, STD_ULOGIC, BIT, STD_LOGIC_VECTOR, STD_ULOGIC_VECTOR, and BIT_VECTOR
- INTEGER and NATURAL
- REAL
- TIME
- Enumerated types, including user-defined enumerated types and CHARACTER

The interface also supports all subtypes and arrays of the preceding types.

Note: The HDL Verifier software does not support VHDL extended identifiers for the following components:

- Port and signal names used in cosimulation
- Enum literals when used as array indices of port and signal names used in cosimulation

However, the software does support basic identifiers for VHDL.

Port Data Types for Verilog Entities

In your module definition, you must define each port that you plan to test with MATLAB with a Verilog port data type that is supported by the HDL Verifier software. The interface can convert data of the following Verilog port types to comparable MATLAB types:

- reg
- integer
- wire

Note: HDL Verifier software does not support Verilog escaped identifiers for port and signal names used in cosimulation. However, it does support simple identifiers for Verilog.

Compile and Elaborate HDL Design for Test Bench Use

Refer to the HDL simulator documentation for instruction in compiling and elaborating the HDL design.

Start HDL Simulator

In this section...

“Start HDL Simulator from MATLAB” on page 4-12

“Load Instance of HDL Module for Test Bench Cosimulation” on page 4-12

Start HDL Simulator from MATLAB

Start the HDL simulator directly from MATLAB by calling the HDL Verifier function `vsim` or `nclaunch`.

```
>>vsim
```

Note that if both tools (MATLAB and the HDL simulator) are not running on the same system, you must start the HDL simulator manually and load the HDL Verifier libraries yourself. See “HDL Verifier Libraries” on page 8-10.

You can call `vsim` or `nclaunch` with additional parameters; see the reference pages for details.

You must make sure the HDL simulator executables — also called `vsim` (ModelSim) and `nclaunch` (Cadence Incisive) — are on the system path. See your system documentation for instruction on setting environment variables.

Linux Users Make sure the HDL simulator executable is still on the system path after the shell is launched from MATLAB. If it is not, make sure the shell startup file does not remove it from the path environment variable.

Load Instance of HDL Module for Test Bench Cosimulation

Incisive users load an instance of the HDL module for cosimulation using the `hdlsimulink` function. ModelSim users do the same using the `vsimulink` function.

Example of loading HDL Module instance — Incisive users

After you start the HDL simulator from MATLAB, load an instance of an HDL module for cosimulation with the function `hdlsimulink`. Issue the command for each instance of an HDL module in your model that you want to cosimulate.

For example:

```
hdlsimulink work.manchester
```

Example of loading HDL Module instance — ModelSim users

After you start the HDL simulator from MATLAB, load an instance of an HDL module for cosimulation with the function `vsimulink`. Issue the command for each instance of an HDL module in your model that you want to cosimulate.

For example:

```
vsimulink work.manchester
```

This command opens a simulation workspace for `manchester` and displays a series of messages in the HDL simulator command window as the simulator loads the packages and architectures for the HDL module.

Add HDL Cosimulation Block to Model

In this section...

“Insert HDL Cosimulation Block” on page 4-14

“Connect Block Ports” on page 4-15

Insert HDL Cosimulation Block

After you code one of your model's components in VHDL or Verilog and simulate it in the HDL simulator environment, integrate the HDL representation into your Simulink model as an HDL `Cosimulation` block by performing the following steps:

- 1 Open your Simulink model, if it is not already open.
- 2 Delete the model component that the HDL `Cosimulation` block is to replace.
- 3 In the Simulink Library Browser, click the HDL Verifier block library. You can then select the block library for your supported HDL simulator. Select either the Mentor Graphics ModelSim HDL Cosimulation block, or the Cadence Incisive HDL Cosimulation block, as shown below.

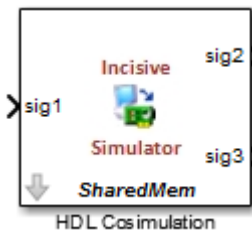
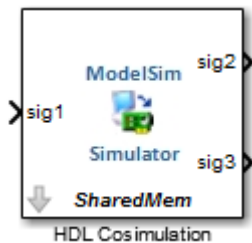

- 4 Copy the HDL Cosimulation block icon from the Library Browser to your model. Simulink creates a link to the block at the point where you drop the block icon.

Connect Block Ports

Connect any HDL Cosimulation block ports to the applicable block ports in your Simulink model.

- To model a sink device, configure the block with inputs only.
- To model a source device, configure the block with outputs only.

Define HDL Cosimulation Block Interface

In this section...

“Open HDL Cosimulation Block Interface” on page 4-16

“Map HDL Signals to Block Ports” on page 4-17

“Specify Signal Data Types” on page 4-32

“Configure Simulink and HDL Simulator Timing Relationship” on page 4-32

“Configure Communication Link in the HDL Cosimulation Block” on page 4-35

“Specify Pre- and Post-Simulation Tcl Commands with HDL Cosimulation Block Parameters Dialog Box” on page 4-37

“Programmatically Control Block Parameters” on page 4-40

Open HDL Cosimulation Block Interface

To open the block parameters dialog box for the HDL `Cosimulation` block, double-click the block icon. Simulink displays the following Block Parameters dialog box (as an example, the dialog box for the HDL `Cosimulation` block for use with ModelSim is shown below).

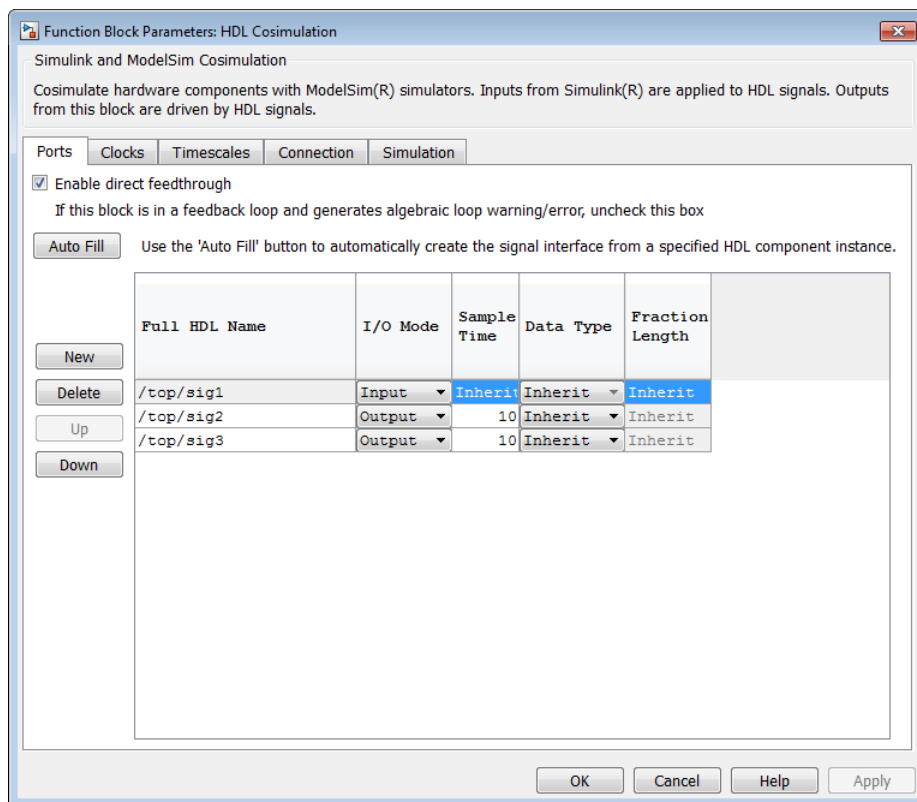

Map HDL Signals to Block Ports

- “Specify HDL Signal/Port and Module Paths for Cosimulation” on page 4-18
- “Get Signal Information from HDL Simulator” on page 4-20
- “Enter Signal Information Manually” on page 4-26
- “Control Output Port Directly by Value of Input Port” on page 4-31

The first step to configuring your HDL Verifier Cosimulation block is to map signals and signal instances of your HDL design to port definitions in your HDL Cosimulation block. In addition to identifying input and output ports, you can specify a sample time for each output port. You can also specify a fixed-point data type for each output port.

The signals that you map can be at any level of the HDL design hierarchy.

To map the signals, you can perform either of the following actions:

- Enter signal information manually into the **Ports** pane of the HDL Cosimulation Block Parameters dialog box. This approach can be more efficient when you want to connect a small number of signals from your HDL model to Simulink. See “Enter Signal Information Manually” on page 4-26.
- Use the **Auto Fill** button to have the HDL Cosimulation block obtain signal information for you by transmitting a query to the HDL simulator. This approach can save significant effort when you want to cosimulate an HDL model that has many signals that you want to connect to your Simulink model. However, in some cases, you will need to edit the signal data returned by the query. See “Get Signal Information from HDL Simulator” on page 4-20 for details.

Note: Verify that signals used in cosimulation have read/write access. For higher performance, you want to provide access only to those signals used in cosimulation. This rule applies to all signals on the **Ports**, **Clocks**, and **Simulation** panes, and to all signals added in any other manner.

Specify HDL Signal/Port and Module Paths for Cosimulation

These rules are for signal/port and module path specifications in Simulink. Other specifications may work but are not explicitly or implicitly supported in this or future releases.

HDL designs generally do have hierarchy; that is the reason for this syntax. This specification does not represent a file name hierarchy.

Path specifications must follow the rules listed in the following sections:

- “Path Specifications for Simulink Cosimulation Sessions with Verilog Top Level” on page 4-18
- “Path Specifications for Simulink Cosimulation Sessions with VHDL Top Level” on page 4-19

Path Specifications for Simulink Cosimulation Sessions with Verilog Top Level

- Path specification must start with a top-level module name.
- Path specification can include "." or "/" path delimiters, but cannot include a mixture.
- The leaf module or signal must match the HDL language of the top-level module.

The following examples show valid signal and module path specifications:

```
top.port_or_sig
/top/sub/port_or_sig
top
top/sub
top.sub1.sub2
```

The following examples show *invalid* signal and module path specifications:

- top.sub/port_or_sig

Why this specification is invalid: You cannot use mixed delimiters.

- :sub:port_or_sig

:

:sub

Why this specification is invalid: When you use VHDL-specific delimiters you limit the interoperability with paths when moving between HDL simulators and between VHDL and Verilog.

Path Specifications for Simulink Cosimulation Sessions with VHDL Top Level

- Path specification may include the top-level module name but it is not required.
- Path specification can include "." or "/" path delimiters, but cannot include a mixture.
- The leaf module or signal must match the HDL language of the top-level module.

The following examples show valid signal and module path specifications:

```
top.port_or_sig
/sub/port_or_sig
top
top/sub
top.sub1.sub2
```

The following examples show *invalid* signal and module path specifications:

- top.sub/port_or_sig

Why this specification is invalid: You cannot use mixed delimiters.

- `:sub:port_or_sig`
:
:sub

Why this specification is invalid: When you use VHDL-specific delimiters you limit the interoperability with paths when moving between HDL simulators and between VHDL and Verilog.

Get Signal Information from HDL Simulator

The **Auto Fill** button lets you begin an HDL simulator query and supply a path to a component or module in an HDL model under simulation in the HDL simulator. Usually, some change of the port information is required after the query completes. You must have the HDL simulator running with the HDL module loaded for **Auto Fill** to work.

The following example describes the required steps.

Note: The example is based on a modified copy of the Manchester Receiver model, in which all signals were first deleted from the **Ports** and **Clocks** panes.

- 1 Open the block parameters dialog box for the HDL Cosimulation block. Click the **Ports** tab. The **Ports** pane opens (as an example, the **Ports** pane for the HDL Cosimulation block for use with ModelSim is shown in the illustrations below).

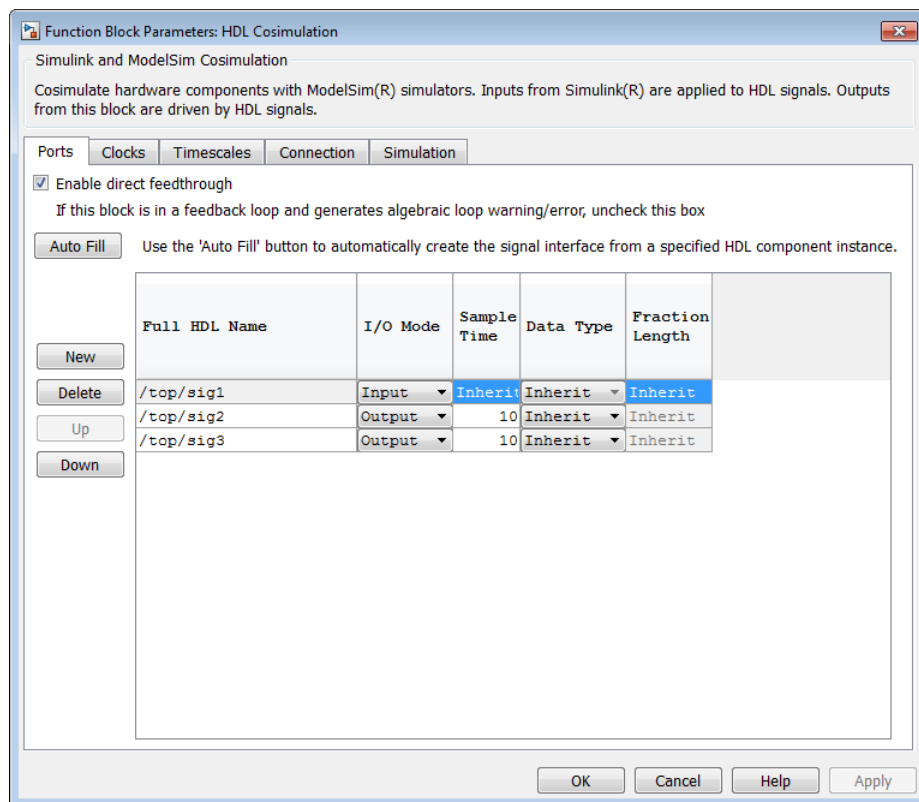

Tip Delete all ports before performing **Auto Fill** to make sure that no unused signal remains in the Ports list at any time.

- 2 Click the **Auto Fill** button. The **Auto Fill** dialog box opens.

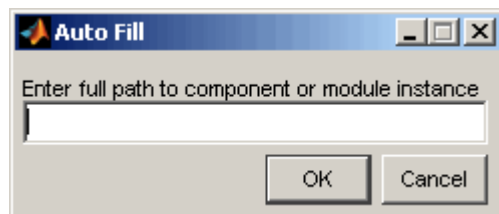

This modal dialog box requests an instance path to a component or module in your HDL model; here you enter an explicit HDL path into the edit field. The path you enter is not a file path and has nothing to do with the source files.

- 3 In this example, the Auto Fill feature obtains port data for a VHDL component called **manchester**. The HDL path is specified as `/top/manchester`. Path specifications will vary depending on your HDL simulator, see “Specify HDL Signal/Port and Module Paths for Cosimulation” on page 4-18.

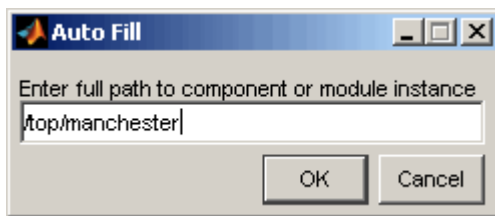

- 4 Click **OK** to dismiss the dialog box and the query is transmitted.
- 5 After the HDL simulator returns the port data, the Auto Fill feature enters it into the **Ports** pane, as shown in the following figure (examples shown for use with Cadence Incisive).

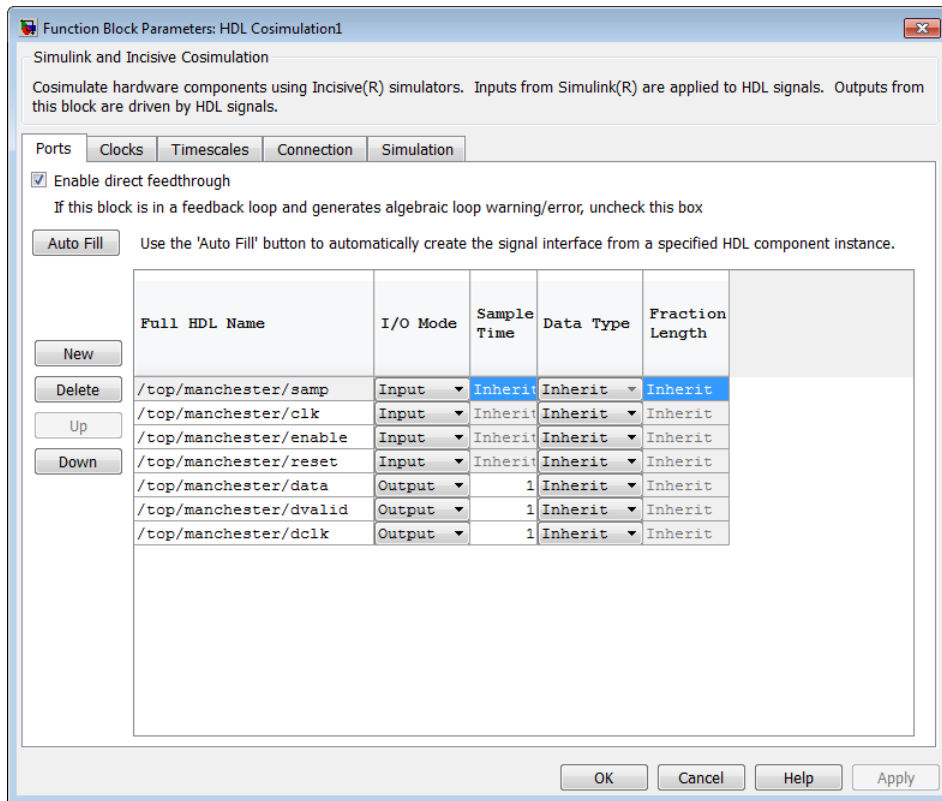

- 6 Click **Apply** to commit the port additions.
- 7 Delete unused signals from Ports pane and add Clock signal.

The preceding figure shows that the query entered clock, clock enable, and reset ports (labeled `clk`, `enable`, and `reset` respectively) into the ports list.

Delete the `enable` and `reset` signals from the **Ports** pane, and add the `clk` signal in the **Clocks** pane.

These actions result in the signals shown in the next figures.

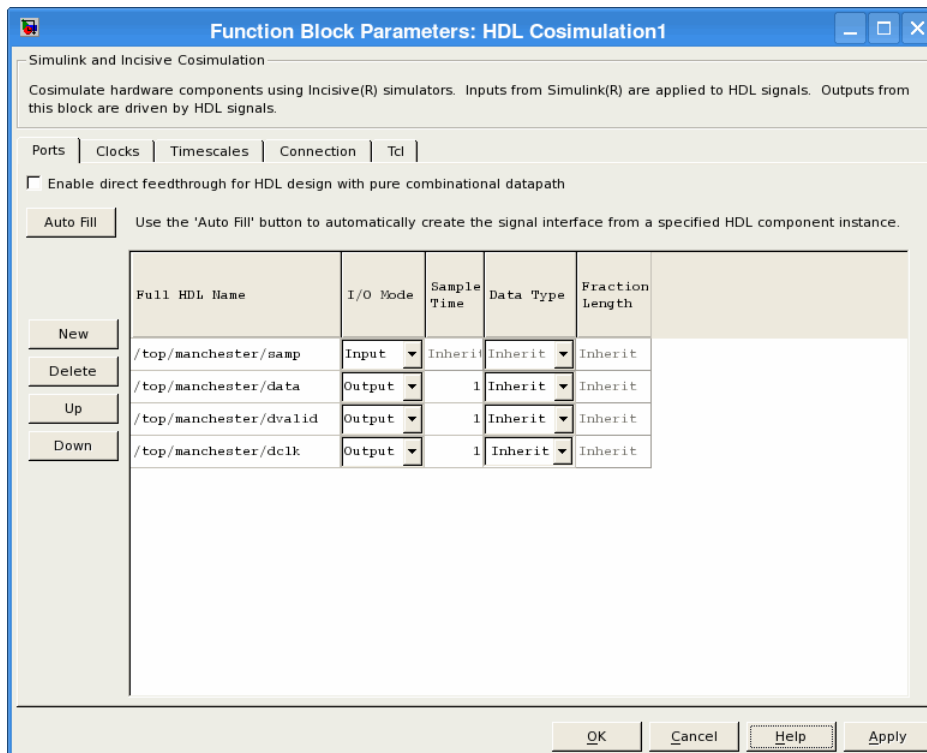

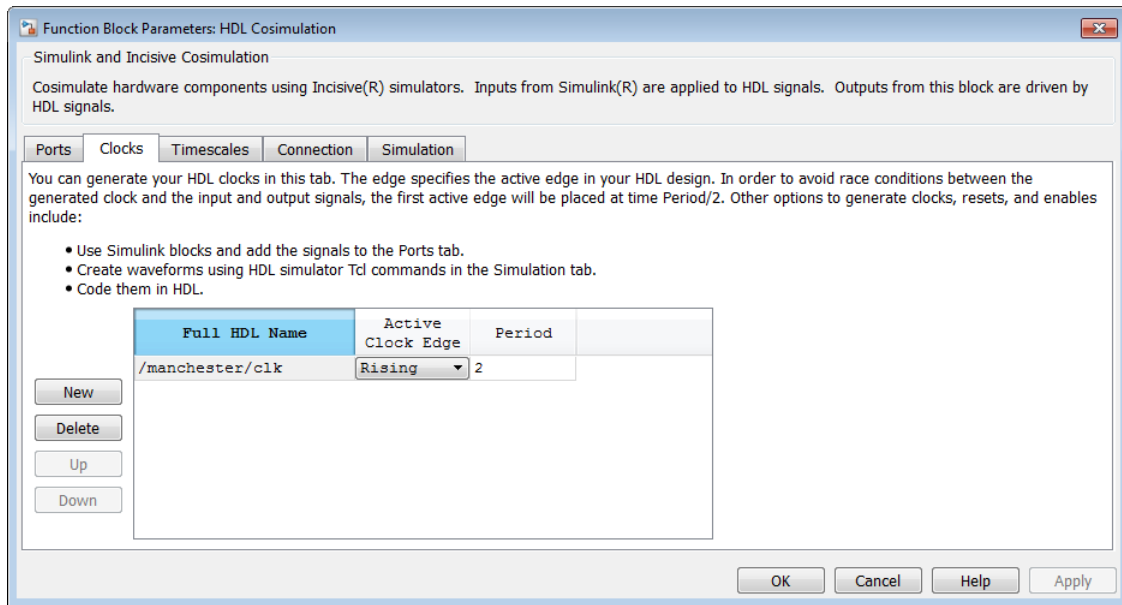

8 Auto Fill returns default values for output ports:

- **Sample time:** 1
- **Data type:** Inherit
- **Fraction length:** Inherit

You may need to change these values as required by your model. In this example, the **Sample time** should be set to 10 for all outputs. See also “Specify Signal Data Types” on page 4-32.

9 Before closing the HDL Cosimulation block parameters dialog box, click **Apply** to commit any edits you have made.

Observe that **Auto Fill** returned information about *all* inputs and outputs for the targeted component. In many cases, this will include signals that function in the HDL simulator but cannot be connected in the Simulink model. You may delete any such entries from the list in the **Ports** pane if they are unwanted. You *can* drive the signals from Simulink; you just have to define their values by laying down Simulink blocks.

Note that **Auto Fill** does not return information for internal signals. If your Simulink model needs to access such signals, you must enter them into the **Ports** pane manually.

For example, in the case of the Manchester Receiver model, you would need to add output port entries for `top/manchester/sync_i`, `top/manchester/isum_i`, and `top/manchester/qsum_i`, as shown in step 8.

Incisive and ModelSim users: Note that `clk`, `reset`, and `clk_enable` *may* be in the Clocks and Simulation panes but they don't *have* to be. These signals can be ports if you choose to drive them explicitly from Simulink.

Note: When you import VHDL signals using **Auto Fill**, the HDL simulator returns the signal names in all capitals.

Enter Signal Information Manually

To enter signal information directly in the **Ports** pane, perform the following steps:

- 1 In the HDL simulator, determine the signal path names for the HDL signals you plan to define in your block. For example, in the ModelSim simulator, the following wave window shows all signals are subordinate to the top-level module `manchester`.

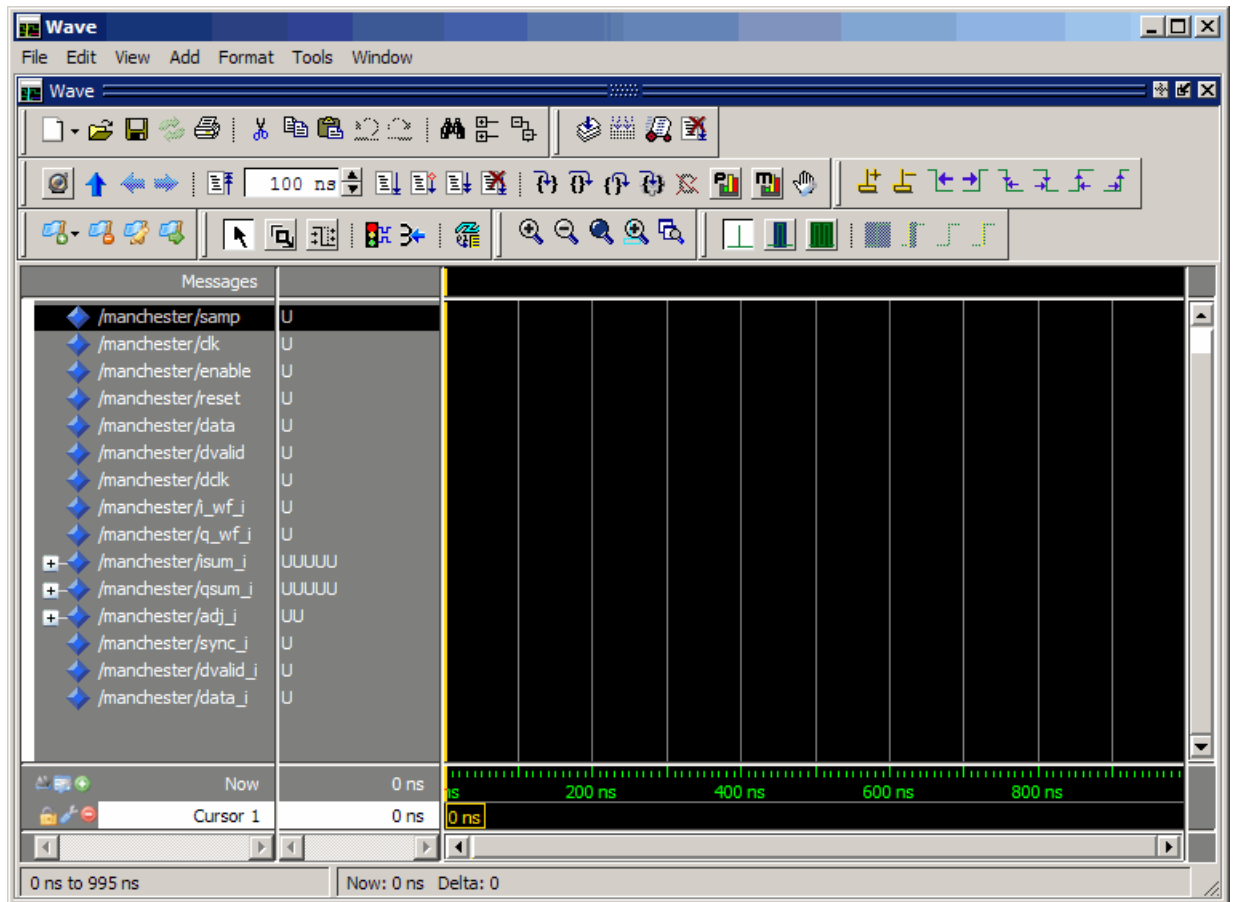

- 2 In Simulink, open the block parameters dialog box for your HDL Cosimulation block, if it is not already open.
- 3 Select the **Ports** pane tab. Simulink displays the following dialog box (example shown for use with Incisive).

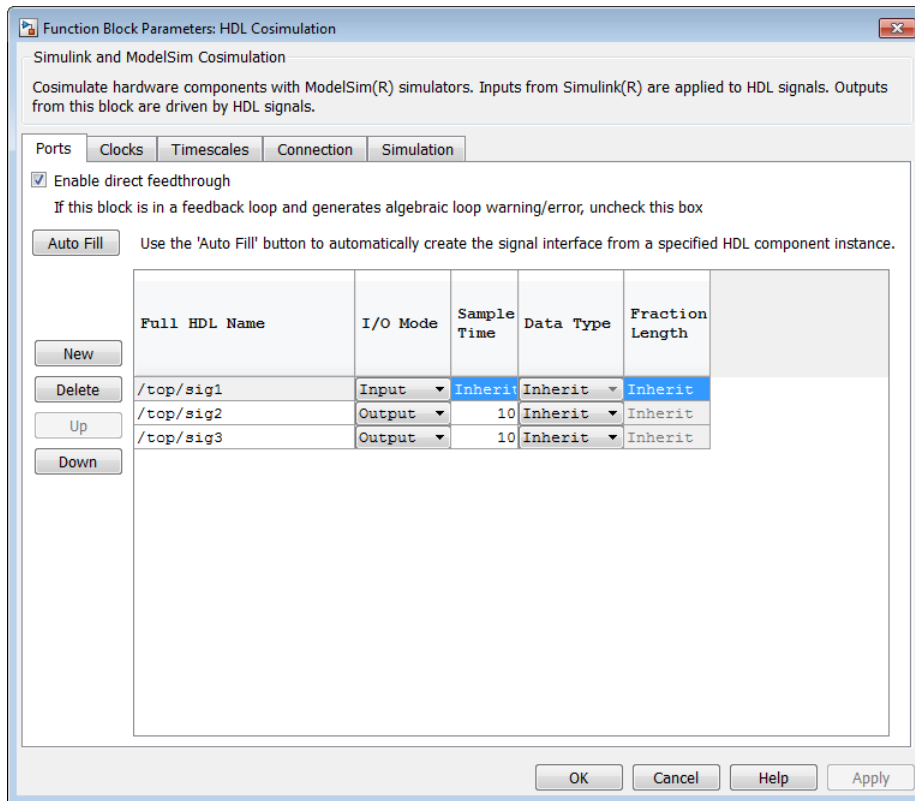

In this pane, you define the HDL signals of your design that you want to include in your Simulink block and set a sample time and data type for output ports. The parameters that you should specify on the **Ports** pane depend on the type of device the block is modeling as follows:

- For a device having both inputs and outputs: specify block input ports, block output ports, output sample times and output data types.

For output ports, accept the default or enter an explicit sample time. Data types can be specified explicitly, or set to `Inherit` (the default). In the default case, the output port data type is inherited either from the signal connected to the port, or derived from the HDL model.

- For a sink device: specify block output ports.

- For a source device: specify block input ports.
- 4** Enter signal path names in the **Full HDL name** column by double-clicking on the existing default signal.
- Use HDL simulator path name syntax (as described in “Specify HDL Signal/Port and Module Paths for MATLAB Test Bench Cosimulation” on page 1-22).
 - If you are adding signals, click **New** and then edit the default values. Select either **Input** or **Output** from the **I/O Mode** column.
 - If you want to, set the **Sample Time**, **Data Type**, and **Fraction Length** parameters for signals explicitly, as discussed in the remaining steps.

When you have finished editing clock signals, click **Apply** to register your changes with Simulink.

The following dialog box shows port definitions for an HDL **Cosimulation** block. The signal path names match path names that appear in the HDL simulator **wave** window (Incisive example shown).

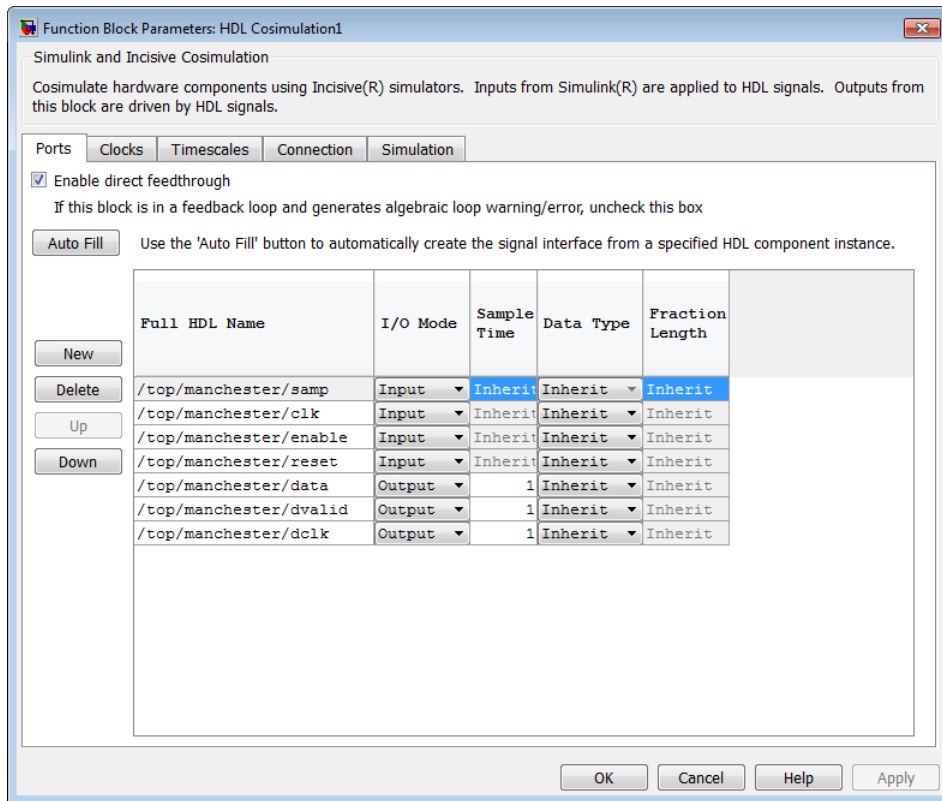

Note: When you define an input port, make sure that only one source is set up to force input to that port. If multiple sources drive a signal, your Simulink model may produce unpredictable results.

- 5 You must specify a sample time for the output ports. Simulink uses the value that you specify, and the current settings of the **Timescales** pane, to calculate an actual simulation sample time.

For more information on sample times in the HDL Verifier cosimulation environment, see “Simulation Timescales” on page 8-57.

- 6 You can configure the fixed-point data type of each output port explicitly if desired, or use a default (**Inherited**). In the default case, Simulink determines the data type for an output port as follows:

If Simulink can determine the data type of the signal connected to the output port, it applies that data type to the output port. For example, the data type of a connected Signal Specification block is known by back-propagation. Otherwise, Simulink queries the HDL simulator to determine the data type of the signal from the HDL module.

To assign an explicit fixed-point data type to a signal, perform the following steps:

- a Select either **Signed** or **Unsigned** from the **Data Type** column.
- b If the signal has a fractional part, enter the **Fraction Length**.

For example, if the model has an 8-bit signal with **Signed** data type and a **Fraction Length** of 5, the HDL Cosimulation block assigns it the data type `sfixed8_En5`. If the model has an **Unsigned** 16-bit signal with no fractional part (a **Fraction Length** of 0), the HDL Cosimulation block assigns it the data type `ufixed16`.

- 7 Before closing the dialog box, click **Apply** to register your edits.

Control Output Port Directly by Value of Input Port

Enabling direct feedthrough allows input port value changes to propagate to the output ports in zero time, thus eliminating the possible delay at output sample in HDL designs with pure combinational logic. Specify the option to enable direct feedthrough on the **Ports** pane, as shown in the following figure.

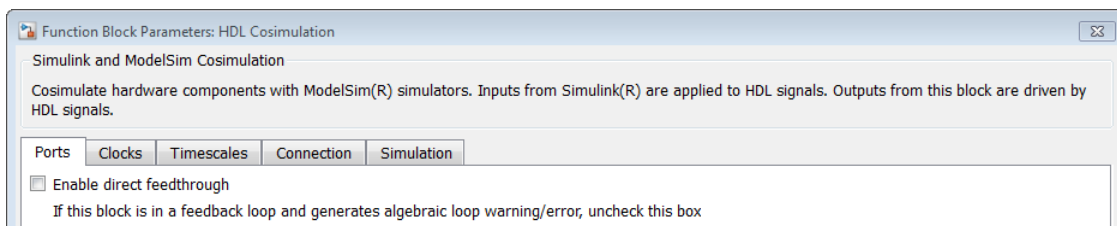

Specify Signal Data Types

The **Data Type** and **Fraction Length** parameters apply only to output signals. See **Data Type** and **Fraction Length** on the Ports pane description of the HDL Cosimulation block.

Configure Simulink and HDL Simulator Timing Relationship

You configure the timing relationship between Simulink and the HDL simulator by using the **Timescales** pane of the block parameters dialog box. Before setting the **Timescales** parameters, read “Simulation Timescales” on page 8-57 to understand the supported timing modes and the issues that will determine your choice of timing mode.

You can specify either a relative or an absolute timing relationship between Simulink and the HDL simulator in the **Timescales** pane, as described in the HDL Cosimulation block reference.

Simulink and HDL Simulator Timing Relationship

The differences in the representation of simulation time can be reconciled in one of two ways using the HDL Verifier interface:

- By defining the timing relationship manually (with **Timescales** pane)

When you define the relationship manually, you determine how many femtoseconds, picoseconds, nanoseconds, microseconds, milliseconds, seconds, or ticks in the HDL simulator represent 1 second in Simulink.

1 second in Simulink corresponds to in the HDL simulator

This quantity of HDL simulator time can be expressed in one of the following ways:

- In *relative* terms (i.e., as some number of HDL simulator ticks). In this case, the cosimulation is said to operate in *relative timing mode*. The HDL Cosimulation block defaults to relative timing mode for cosimulation. For more on relative timing mode, see “Relative Timing Mode” on page 8-60.
- In *absolute* units (such as milliseconds or nanoseconds). In this case, the cosimulation is said to operate in *absolute timing mode*. For more on absolute timing mode, see “Absolute Timing Mode” on page 8-65.

For more on relative and absolute time, see “Simulation Timescales” on page 8-57.

- By allowing HDL Verifier to define the timescale (with **Timescales** pane)

When you allow the link software to define the timing relationship, it attempts to set the timescale factor between the HDL simulator and Simulink to be as close as possible to 1 second in the HDL simulator = 1 second in Simulink. If this setting is not possible, the link product attempts to set the signal rate on the Simulink model port to the lowest possible number of HDL simulator ticks.

Before you begin, verify that the HDL simulator is running. HDL Verifier software can get the resolution limit of the HDL simulator only when that simulator is running.

You can choose to have HDL Verifier calculate a timescale while you are setting the parameters on the block dialog by clicking the **Timescale** option then clicking **Determine Timescale Now** or you can have HDL Verifier calculate the timescale when simulation begins by selecting **Automatically determine timescale at start of simulation**.

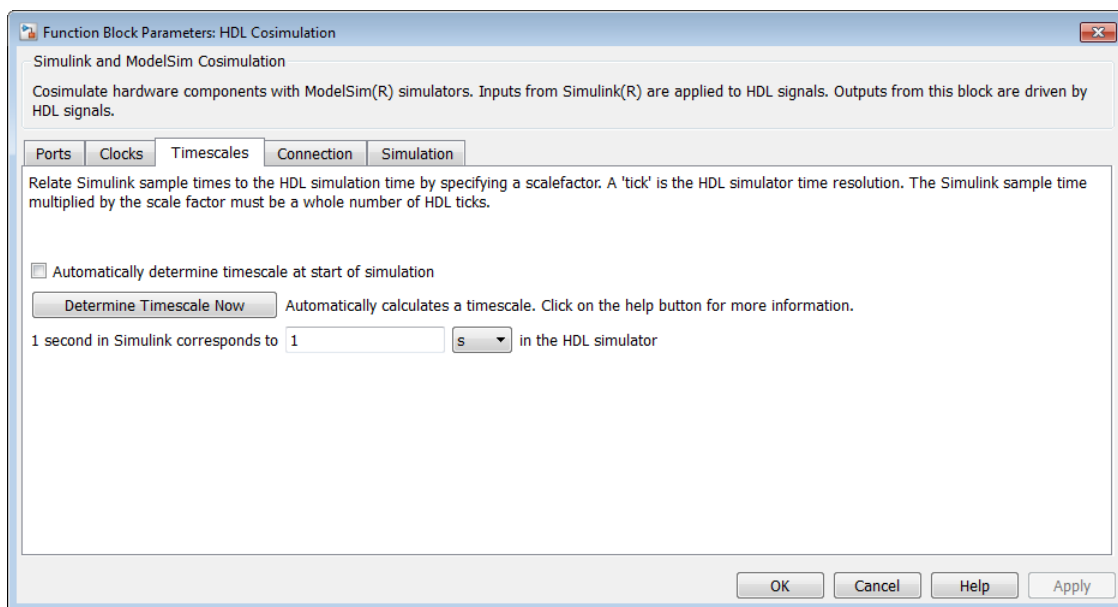

When you click **Determine Timescale Now**, HDL Verifier connects Simulink with the HDL simulator so that it can use the HDL simulator resolution to calculate the best timescale. You can accept the timescale HDL Verifier suggests or you can make changes in the port list directly. If you want to revert to the originally calculated settings, click **Use Suggested Timescale**. If you want to view sample times for all ports in the HDL design, select **Show all ports and clocks**.

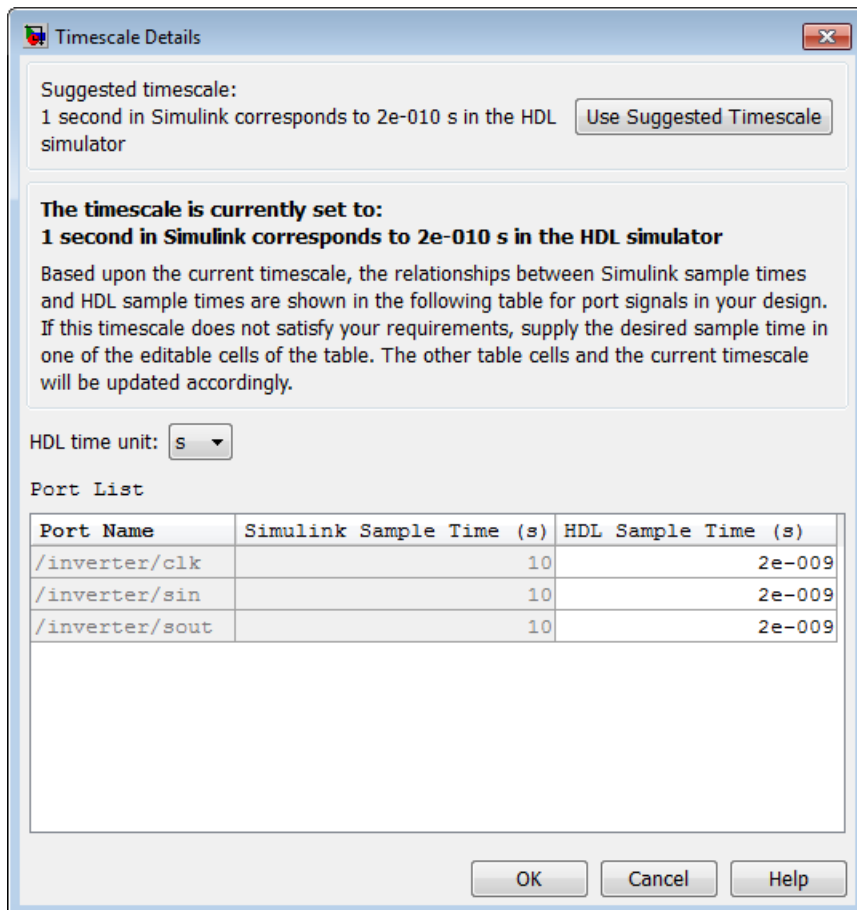

If you select **Automatically determine timescale at start of simulation**, you get the same dialog when the simulation starts in Simulink. Make the same adjustments

at that time, if applicable, that you would if you clicked **Determine Timescale Now** when you were configuring the block.

Configure Communication Link in the HDL Cosimulation Block

You must select shared memory or socket communication. See “HDL Cosimulation with MATLAB or Simulink”.

After you decide which type of communication, configure a block's communication link with the **Connection** pane of the block parameters dialog box (example shown for use with ModelSim).

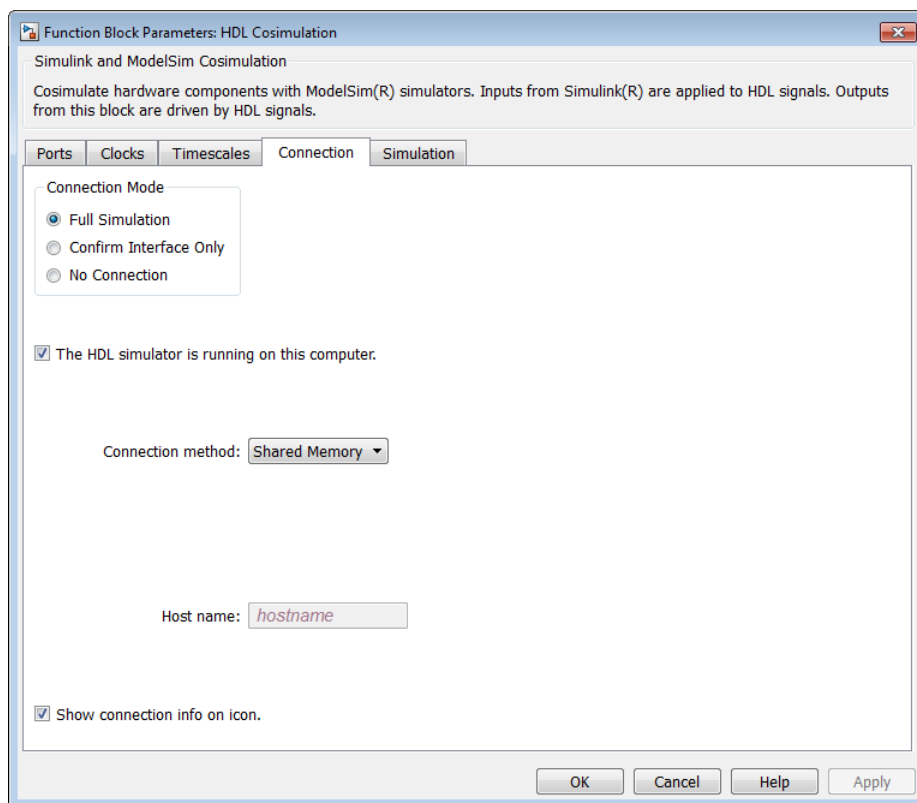

The following steps guide you through the communication configuration:

- 1 Determine whether Simulink and the HDL simulator are running on the same computer. If they are, skip to step 4.
- 2 Clear the **The HDL simulator is running on this computer** check box. (This check box defaults to selected.) Because Simulink and the HDL simulator are running on different computers, HDL Verifier sets the **Connection method** to **Socket**.
- 3 Enter the host name of the computer that is running your HDL simulation (in the HDL simulator) in the **Host name** text field. In the **Port number or service** text field, specify a valid port number or service for your computer system. For information on choosing TCP/IP socket ports, see “TCP/IP Socket Ports” on page 8-77. Skip to step 5.
- 4 If the HDL simulator and Simulink are running on the same computer, decide whether you are going to use shared memory or TCP/IP sockets for the communication channel. For information on the different modes of communication, see “HDL Cosimulation with MATLAB or Simulink”.

If you choose TCP/IP socket communication, specify a valid port number or service for your computer system in the **Port number or service** text field. For information on choosing TCP/IP socket ports, see “TCP/IP Socket Ports” on page 8-77.

If you choose shared memory communication, select the **Shared memory** check box.

- 5 If you want to bypass the HDL simulator when you run a Simulink simulation, use the **Connection Mode** options to specify what type of simulation connection you want. Select one of the following options:
 - **Full Simulation:** Confirm interface and run HDL simulation (default).
 - **Confirm Interface Only:** Check HDL simulator for expected signal names, dimensions, and data types, but do not run HDL simulation.
 - **No Connection:** Do not communicate with the HDL simulator. The HDL simulator does not need to be started.

With the second and third options, HDL Verifier software does not communicate with the HDL simulator during Simulink simulation.

- 6 Click **Apply**.

The following example dialog box shows communication definitions for an HDL Cosimulation block. The block is configured for Simulink and the HDL simulator

running on the same computer, communicating in TCP/IP socket mode over TCP/IP port 4449.

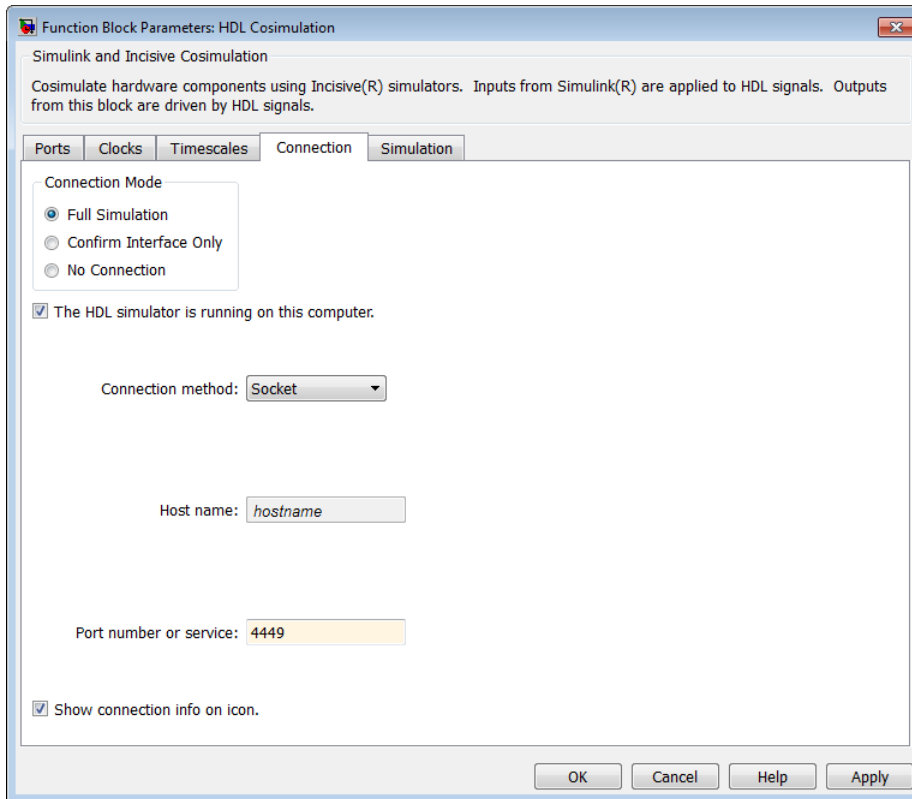

Specify Pre- and Post-Simulation Tcl Commands with HDL Cosimulation Block Parameters Dialog Box

You have the option of specifying Tcl commands to execute before and after the HDL simulator simulates the HDL component of your Simulink model. *Tcl* is a programmable scripting language supported by most HDL simulation environments. Use of Tcl can range from something as simple as a one-line `puts` command to confirm that a simulation is running or as complete as a complex script that performs an extensive simulation initialization and startup sequence. For example, you can use the **Post-simulation command** field on the Simulation Pane to instruct the HDL simulator to restart at the end of a simulation run.

Note for ModelSim Users After each simulation, it takes ModelSim time to update the coverage result. To prevent the potential conflict between this process and the next cosimulation session, add a short pause between each successive simulation.

You can specify the pre-simulation and post-simulation Tcl commands by entering Tcl commands in the **Pre-simulation** commands or **Post-simulation** commands text fields in the **Simulation** pane of the HDL Cosimulation block mask.

To specify Tcl commands, perform the following steps:

- 1 Select the **Simulation** tab of the Block Parameters dialog box. The dialog box appears as follows (example shown for use with ModelSim).

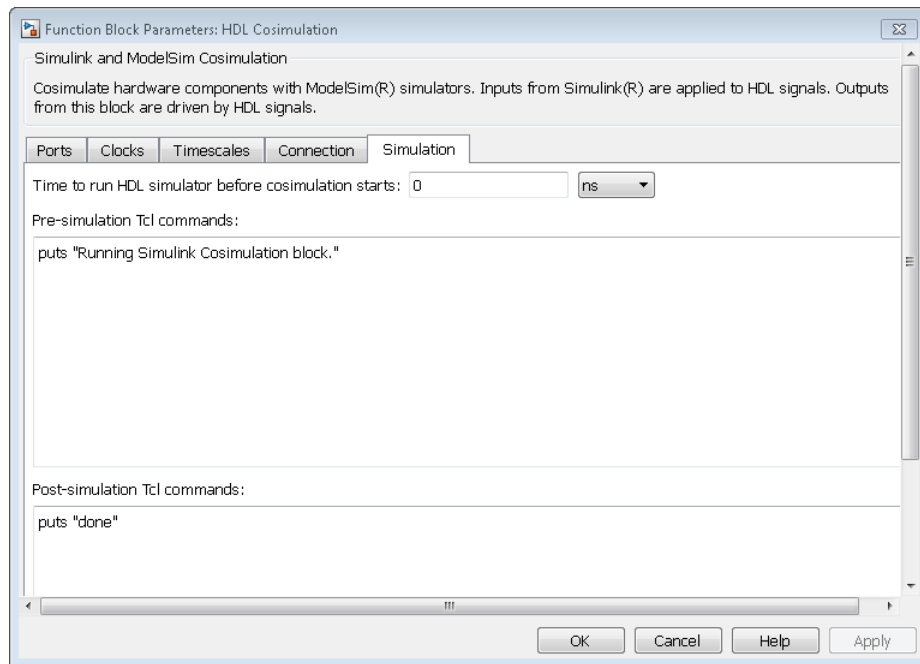

The **Pre-simulation commands** text box includes a `puts` command for reference purposes.

- 2 Enter one or more commands in the **Pre-simulation command** and **Post-simulation command** text boxes. You can specify one Tcl command per line in the

text box or enter multiple commands per line by appending each command with a semicolon (;), which is the standard Tcl concatenation operator.

ModelSim DO Files

Alternatively, you can create a ModelSim DO file that lists Tcl commands and then specify that file with the ModelSim `do` command as shown in the following figure.

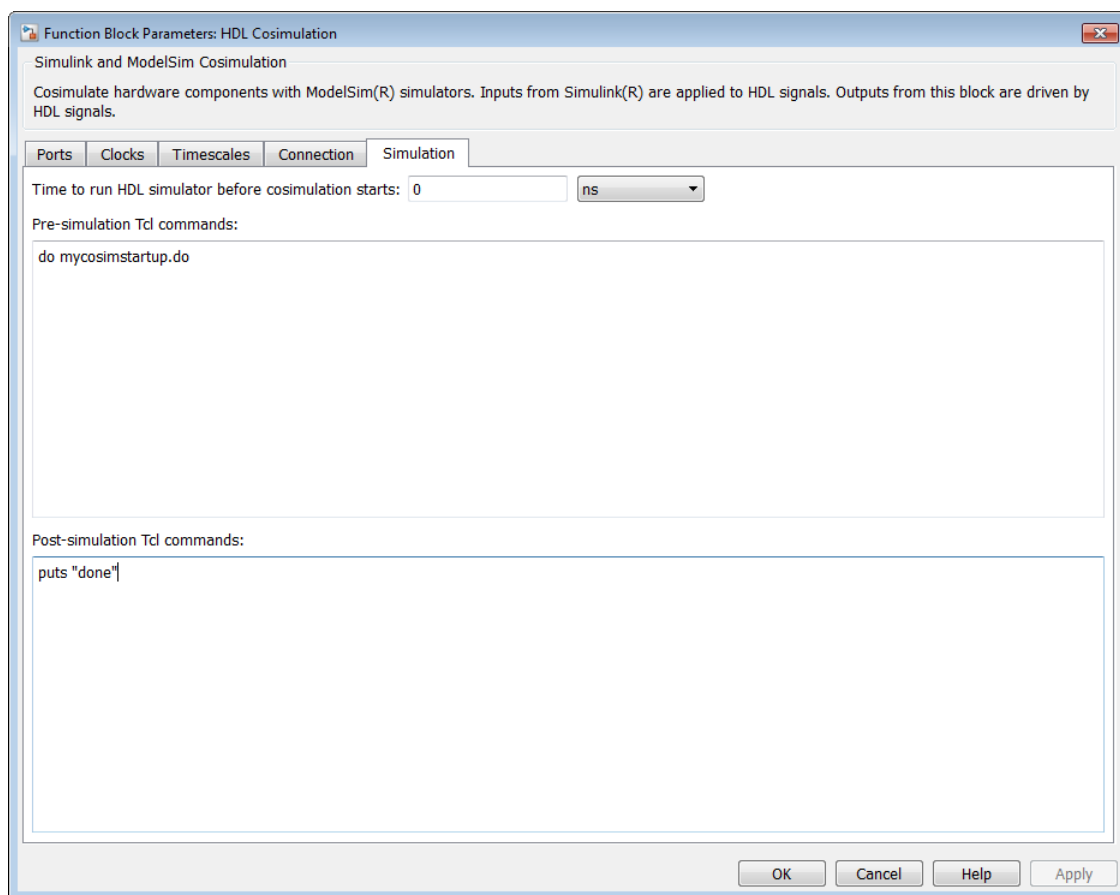

3 Click **Apply**.

Programmatically Control Block Parameters

One way to control block parameters is through the HDL `Cosimulation` block graphical dialog box. However, you can also control blocks by programmatically controlling the mask parameter values and the running of simulations. Parameter values can be read using the Simulink `get_param` function and written using the Simulink `set_param` function. All block parameters have attributes that indicate whether they are:

- **Tunable** — The attributes can change during the simulation run.
- **Evaluated** — The parameter string value undergoes an evaluation to determine its actual value used by the S-Function.

The HDL `Cosimulation` block does not have any tunable parameters; thus, you get an error if you try to change a value while the simulation is running. However, it does have a few evaluated parameters.

You can see the list of parameters and their attributes by performing a right-mouse click on the block, selecting **View Mask**, and then the **Parameters** tab. The **Variable** column shows the programmatic parameter names. Alternatively, you can get the names programmatically by selecting the HDL `Cosimulation` block and then typing the following commands at the MATLAB prompt:

```
>> get_param(gcb, 'DialogParameters')
```

Some examples of using MATLAB to control simulations and mask parameter values follow. Usually, the commands are put into a script or function file and are called by several callback hooks available to the model developer. You can place the code in any of these suggested locations, or anywhere you choose:

- In the model workspace, for example, **View > Model Explorer > Simulink Root > *model_name* > Model Workspace**, option **Data Source** is set to `Model File`.
- In a model callback, for example, **File > Model Properties > Callbacks**.
- A subsystem callback (right-mouse click on an empty subsystem and then select **Properties > Callbacks**). Many of the HDL Verifier demos use this technique to start the HDL simulator by placing MATLAB code in the `OpenFcn` callback.
- The HDL `Cosimulation` block callback (right-mouse click on HDL `Cosimulation` block, and then select **Properties > Callbacks**).

Example: Scripting the Value of the Socket Number for HDL Simulator Communication

In a regression environment, you may need to determine the socket number for the Simulink/HDL simulator connection during the simulation to avoid collisions with other simulation runs. This example shows code that could handle that task. The script is for a 32-bit Linux platform.

```
ttcp_exec = [matlabroot '/toolbox/shared/hdlink/scripts/ttcp_glnx'];
[status, results] = system([ttcp_exec ' -a']);
if ~s
    parsed_result = textscan(results, '%s');
    avail_port = parsed_result{1}{2};
else
    error(results);
end

set_param('MyModel/HDL Cosimulation', 'CommPortNumber', avail_port);
```

Run a Test Bench Cosimulation Session

In this section...

“Set Simulink Model Configuration Parameters” on page 4-42

“Determine Available Socket Port Number” on page 4-43

“Check Connection Status” on page 4-43

“Run and Test Test Bench Cosimulation Model” on page 4-43

“Avoid Race Conditions in HDL Simulation with Test Bench Cosimulation and the HDL Verifier HDL Cosimulation Block” on page 4-46

Set Simulink Model Configuration Parameters

When you create a Simulink model that includes one or more HDL Verifier Cosimulation blocks, you might want to adjust certain Simulink parameter settings to best meet the needs of HDL modeling. For example, you might want to adjust the value of the **Stop time** parameter in the **Solver** pane of the Model Configuration Parameters dialog box.

You can adjust the parameters individually or you can use DSP System Toolbox™ Simulink model templates to automatically configure the Simulink environment with the recommended settings for digital signal processing modeling.

Parameter	Default Setting
'SingleTaskRateTransMsg'	'error'
'Solver'	'fixedstepdiscrete'
'SolverMode'	'singletasking'
'StartTime'	'0.0'
'StopTime'	'inf'
'FixedStep'	'auto'
'SaveTime'	'off'
'SaveOutput'	'off'
'AlgebraicLoopMsg'	'error'

The default settings for `SaveTime` and `SaveOutput` improve simulation performance.

For more information on DSP System Toolbox Simulink model templates, see the DSP System Toolbox documentation.

Determine Available Socket Port Number

To determine an available socket number use: `ttcp -a` a shell prompt.

Check Connection Status

You can check the connection status by clicking the Update diagram button or by selecting **Simulation > Update Diagram**. If you have an error in the connection, Simulink will notify you.

The MATLAB command `pingHdlSim` can also be used to check the connection status. If a -1 is returned, then there is no connection with the HDL simulator.

Run and Test Test Bench Cosimulation Model

In general, the last stage of cosimulation is to run and test your model. There are some steps you must be aware of when changing your model during or between cosimulation sessions. although your testing methods may vary depending on which HDL simulator you have, You can review these steps in “Run and Test Test Bench Cosimulation Model” on page 4-43.

You can run the cosimulation in one of three ways:

- “Cosimulation Using the Simulink and HDL Simulator GUIs” on page 4-43
- “Cosimulation with Simulink Using the Command Line Interface (CLI)” on page 4-44
- “Cosimulation with Simulink Using Batch Mode” on page 4-45

Cosimulation Using the Simulink and HDL Simulator GUIs

Start the HDL simulator and load your HDL design. For test bench cosimulation, begin simulation first in the HDL simulator. Then, in Simulink, click **Simulation > Run** or the Run Simulation button. Simulink runs the model and displays any errors that it detects. You can alternate between the HDL simulator and Simulink GUIs to monitor the cosimulation results.

For component cosimulation, start the simulation in Simulink first, then begin simulation in the HDL simulator.

You can specify "GUI" as the property value for the run mode parameter of the HDL Verifier HDL simulator launch command, but since using the GUI is the default mode for HDL Verifier, you do not have to.

Cosimulation with Simulink Using the Command Line Interface (CLI)

Running your cosimulation session using the command-line interface allows you to interact with the HDL simulator during cosimulation, which can be helpful for debugging.

To use the CLI, specify "CLI" as the property value for the run mode parameter of the HDL Verifier HDL simulator launch command.

Caution Close the terminal window by entering `quit -f` at the command prompt. Do not close the terminal window by clicking the "X" in the upper right-hand corner. This causes a memory-type error to be issued from the system. This is not a bug with HDL Verifier but just the way the HDL simulator behaves in this context.

You can type CTRL+C to interrupt and terminate the simulation in the HDL simulator but this action also causes the memory-type error to be displayed.

Specify CLI mode with `nclaunch` (Cadence Incisive)

Issue the `nclaunch` command with "CLI" as the runmode property value, as follows (example entered into the MATLAB editor):

```
tclcmd = { ['cd ',unixprojdir],...
           ['exec ncvlog -linedebug ',unixsrcfile1],...
           'exec ncelab -access +wc work.inverter_v1',...
           'hdlsimulink -gui work.inverter_v1'
};

nclaunch('tclstart',tclcmd,'runmode','CLI');
```

Specify CLI mode with `vsim` (Mentor Graphics ModelSim)

Issue the `vsim` command with "CLI" as the runmode property value, as follows (example entered into the MATLAB editor):

```
tclcmd = {'vlib work',...
         'vlog addone_vlog.v add_vlog.v top_frame.v',...
         'vsimulink top =socket 5002'};

vsim('tclstart',tclcmd,'runmode','CLI');
```

Cosimulation with Simulink Using Batch Mode

Running your cosimulation session in batch mode allows you to keep the process in the background, reducing demand on memory by disengaging the GUI.

To use the batch mode, specify "Batch" as the property value for the run mode parameter of the HDL Verifier HDL simulator launch command. After you issue the HDL Verifier HDL simulator launch command with batch mode specified, start the simulation in Simulink. To stop the HDL simulator before the simulation is completed, issue the `breakHdlSim` command.

Specify Batch mode with nclaunch (Cadence Incisive)

Issue the `nclaunch` command with 'Batch' as the runmode parameter, as follows:

```
nclaunch('tclstart',manchestercmds,'runmode','Batch')
```

You can also set runmode to 'Batch with Xterm', which starts the HDL simulator in the background but shows the session in an Xterm.

Specify Batch mode with vsim (Mentor Graphics ModelSim)

On Windows, specifying batch mode causes ModelSim to be run in a non-interactive command window. On Linux, specifying batch mode causes ModelSim to be run in the background with no window.

Issue the `vsim` command with 'Batch' as the runmode parameter, as follows:

```
>> vsim('tclstart',manchestercmds,'runmode','Batch')
```

Test Cosimulation

If you wish to reset a clock during a cosimulation, you can do so in one of these ways:

- By entering HDL simulator `force` commands at the HDL simulator command prompt

- By specifying HDL simulator `force` commands in the **Post- simulation command** text field on the **Simulation** pane of the HDL Verifier Cosimulation block parameters dialog box.

See also “Clock, Reset, and Enable Signals” on page 8-70.

If you change any part of the Simulink model, including the HDL Cosimulation block parameters, update the diagram to reflect those changes. You can do this update in one of the following ways:

- Rerun the simulation
- Click the Update diagram button
- Select **Simulation > Update Diagram**

Avoid Race Conditions in HDL Simulation with Test Bench Cosimulation and the HDL Verifier HDL Cosimulation Block

In the HDL simulator, you cannot control the order in which clock signals (rising-edge or falling-edge) defined in the HDL Cosimulation block are applied, relative to the data inputs driven by these clocks. If you are careful to verify the relationship between the data and active edges of the clock, you can avoid race conditions that could create differing cosimulation results. See “Race Conditions in HDL Simulators” on page 8-46.

Verify HDL Model with Simulink Test Bench

In this section...

“Tutorial Overview” on page 4-47

“Develop VHDL Code” on page 4-47

“Compile VHDL” on page 4-49

“Create Simulink Model” on page 4-50

“Set Up ModelSim for Use with Simulink” on page 4-59

“Load Instances of VHDL Entity for Cosimulation with Simulink” on page 4-60

“Run Simulation” on page 4-61

“Shut Down Simulation” on page 4-64

Tutorial Overview

This chapter guides you through the basic steps for setting up an HDL Verifier session that uses Simulink and the HDL Cosimulation block to verify an HDL model. The HDL Cosimulation block cosimulates a hardware component by applying input signals to and reading output signals from an HDL model under simulation in ModelSim/Quarta[®] Sim. The HDL Cosimulation block supports simulation of either VHDL or Verilog models. In the tutorial in this section, you will cosimulate a simple VHDL model.

Note: This tutorial is specific to Mentor Graphics simulator users; however, much of the process will be the same for Incisive users.

Develop VHDL Code

A typical Simulink and ModelSim scenario is to create a model for a specific hardware component in ModelSim that you later need to integrate into a larger Simulink model. The first step is to design and develop a VHDL model in ModelSim. In this tutorial, you use ModelSim and VHDL to develop a model that represents the following inverter:

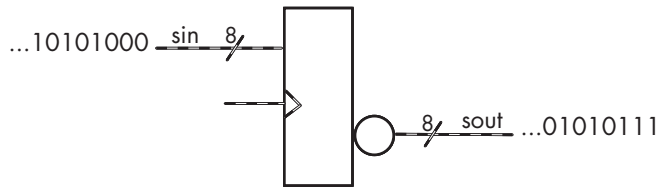

The VHDL entity for this model will represent 8-bit streams of input and output signal values with an IN port and OUT port of type `STD_LOGIC_VECTOR`. An input clock signal of type `STD_LOGIC` will trigger the bit inversion process when set.

Perform the following steps:

- 1 Start ModelSim
- 2 Change to the writable folder `MyPlayArea`, which you may have created for another tutorial. If you have not created the folder, create it now. The folder must be writable.

```
ModelSim>cd C:/MyPlayArea
```

- 3 Open a new VHDL source edit window.
- 4 Add the following VHDL code:

```
-----  
-- Simulink and ModelSim Inverter Tutorial  
--  
-- Copyright 2003-2004 The MathWorks, Inc.  
--  
-----  
LIBRARY ieee;  
USE ieee.std_logic_1164.ALL;  
ENTITY inverter IS PORT (  
    sin : IN  std_logic_vector(7 DOWNTO 0);  
    sout: OUT std_logic_vector(7 DOWNTO 0);  
    clk : IN  std_logic  
);  
END inverter;  
  
LIBRARY ieee;  
USE ieee.std_logic_1164.ALL;  
ARCHITECTURE behavioral OF inverter IS  
BEGIN  
    PROCESS(clk)
```

```

BEGIN
  IF (clk'EVENT AND clk = '1') THEN
    sout <= NOT sin;
  END IF;
END PROCESS;
END behavioral;

```

- 5 Save the file to `inverter.vhd`.

Compile VHDL

This section explains how to set up a design library and compile `inverter.vhd`, as follows:

- 1 Verify that the file `inverter.vhd` is in the current folder by entering the `ls` command at the ModelSim command prompt.
- 2 Create a design library to hold your compilation results. To create the library and required `_info` file, enter the `vlib` and `vmap` commands as follows:

```
ModelSim> vlib work
```

```
ModelSim> vmap work work
```

If the design library `work` already exists, ModelSim *does not* overwrite the current library, but displays the following warning:

```
# ** Warning: (vlib-34) Library already exists at "work".
```

Note: You must use the ModelSim **File** menu or `vlib` command to create the library folder so that the required `_info` file is created. Do not create the library with operating system commands.

- 3 Compile the VHDL file. One way of compiling the file is to click the file name in the project workspace and select **Compile > Compile All**. Another alternative is to specify the name of the VHDL file with the `vcom` command, as follows:

```
ModelSim> vcom inverter.vhd
```

If the compilations succeed, informational messages appear in the command window and the compiler populates the work library with the compilation results.

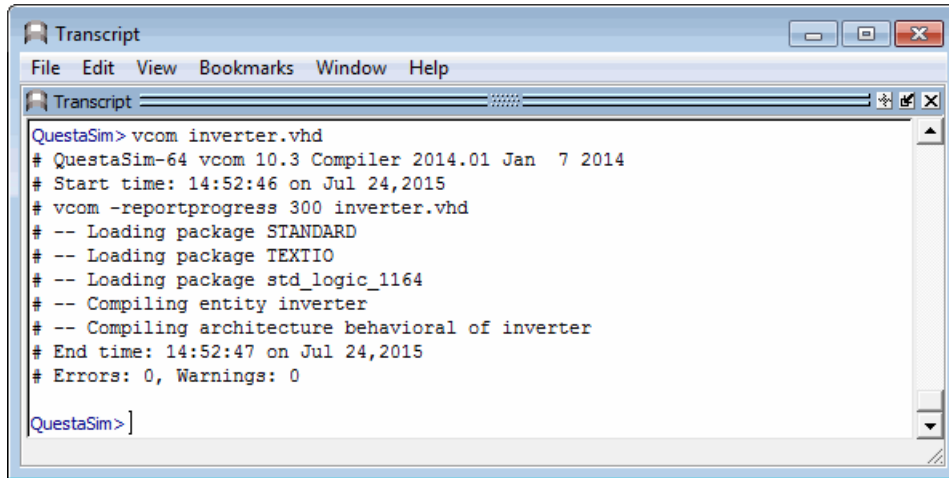

```
Transcript
File Edit View Bookmarks Window Help
Transcript
QuestaSim> vcom inverter.vhd
# QuestaSim-64 vcom 10.3 Compiler 2014.01 Jan 7 2014
# Start time: 14:52:46 on Jul 24,2015
# vcom -reportprogress 300 inverter.vhd
# -- Loading package STANDARD
# -- Loading package TEXTIO
# -- Loading package std_logic_1164
# -- Compiling entity inverter
# -- Compiling architecture behavioral of inverter
# End time: 14:52:47 on Jul 24,2015
# Errors: 0, Warnings: 0
QuestaSim> ]
```

Create Simulink Model

Now create your Simulink model. For this tutorial, you create a simple Simulink model that drives input into a block representing the VHDL inverter you coded in “Develop VHDL Code” on page 4-47 and displays the inverted output.

Start by creating a model, as follows:

- 1 Start MATLAB, if it is not already running. Open a new model window. Then, open the Simulink **Library Browser**.
- 2 Drag the following blocks from the Simulink **Library Browser** to your model window:
 - Constant block from the Simulink **Sources** library
 - HDL **Cosimulation** block from the HDL Verifier block library
 - Display block from the Simulink **Sinks** library

Arrange the three blocks in the order shown in the following figure.

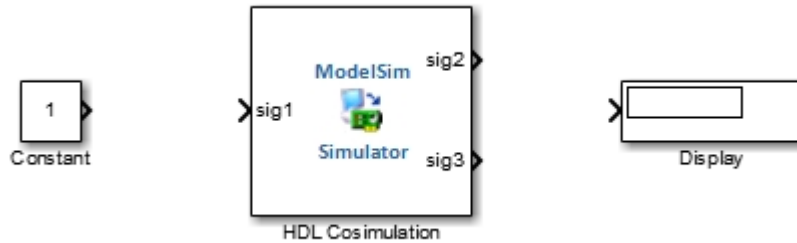

Next, configure the **Constant** block, which is the model's input source, by performing the following actions:

- 1 Double-click the **Constant** block icon to open the **Constant** block parameters dialog box. Enter the following parameter values in the **Main** pane:
 - **Constant value:** 0
 - **Sample time:** 10

Later you can change these initial values to see the effect various sample times have on different simulation runs.

The dialog box should now appear as follows.

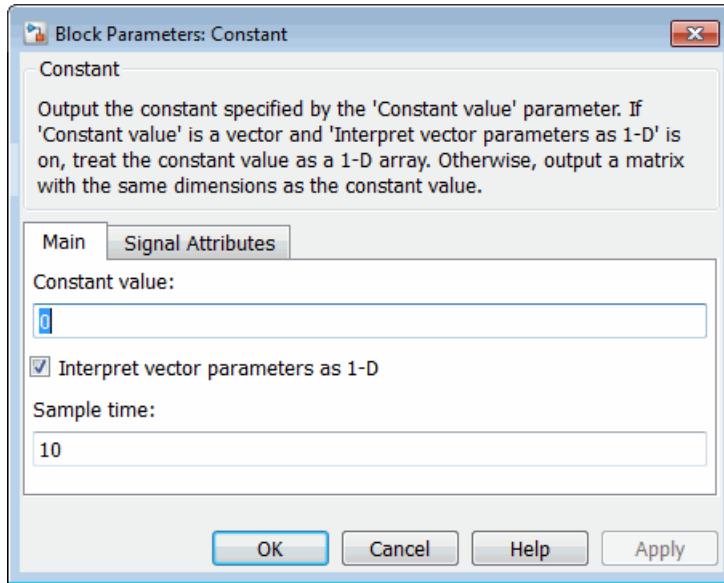

- 2 Click the **Signal Attributes** tab. The dialog box now displays the **Output data type** menu.

Select `uint8` from the **Output data type** menu. This data type specification is supported by HDL Verifier software without the need for a type conversion. It maps directly to the VHDL type for the VHDL port `sin`, `STD_LOGIC_VECTOR(7 DOWNTO 0)`.

The dialog box should now appear as follows.

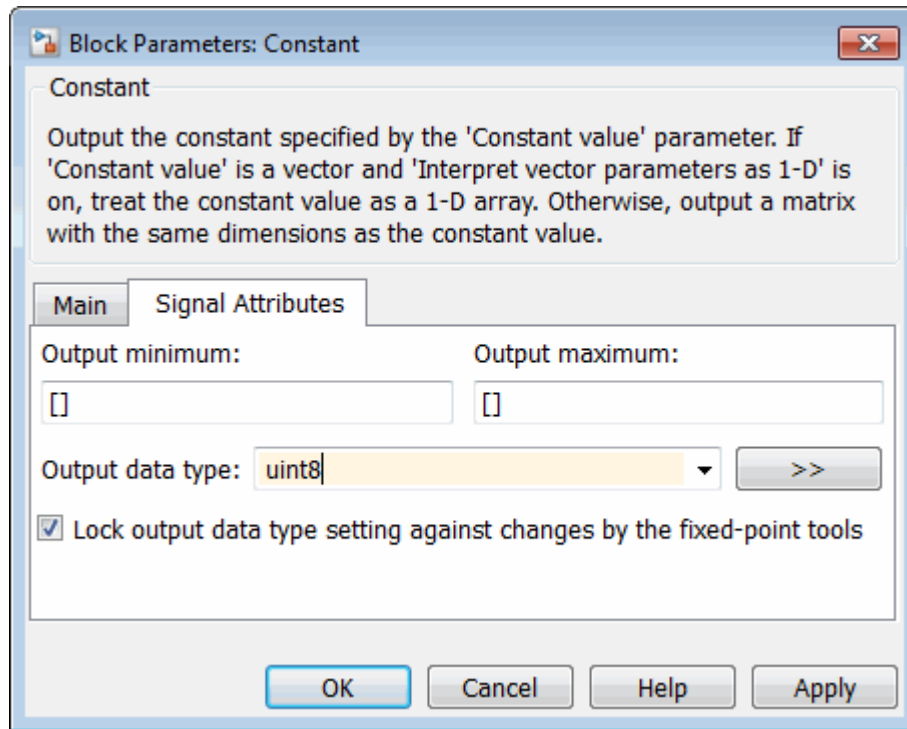

- 3 Click **OK**. The Constant block parameters dialog box closes and the value in the Constant block icon changes to 0.

Next, configure the HDL Cosimulation block, which represents the inverter model written in VHDL. Start with the **Ports** pane, by performing the following actions:

- 1 Double-click the HDL Cosimulation block icon. The **Block Parameters** dialog box for the HDL Cosimulation block appears. Click the **Ports** tab.
- 2 In the **Ports** pane, select the sample signal `/top/sig1` from the signal list in the center of the pane by double-clicking on it.
- 3 Replace the sample signal path name `/top/sig1` with `/inverter/sin`. Then click **Apply**. The signal name on the HDL Cosimulation block changes.
- 4 Similarly, select the sample signal `/top/sig2`. Change the **Full HDL Name** to `/inverter/sout`. Select **Output** from the **I/O Mode** list. Change the **Sample Time** parameter to 10. Then click **Apply** to update the list.

- 5 Select the sample signal `/top/sig3`. Click the **Delete** button. The signal is now removed from the list.

The **Ports** pane should appear as follows.

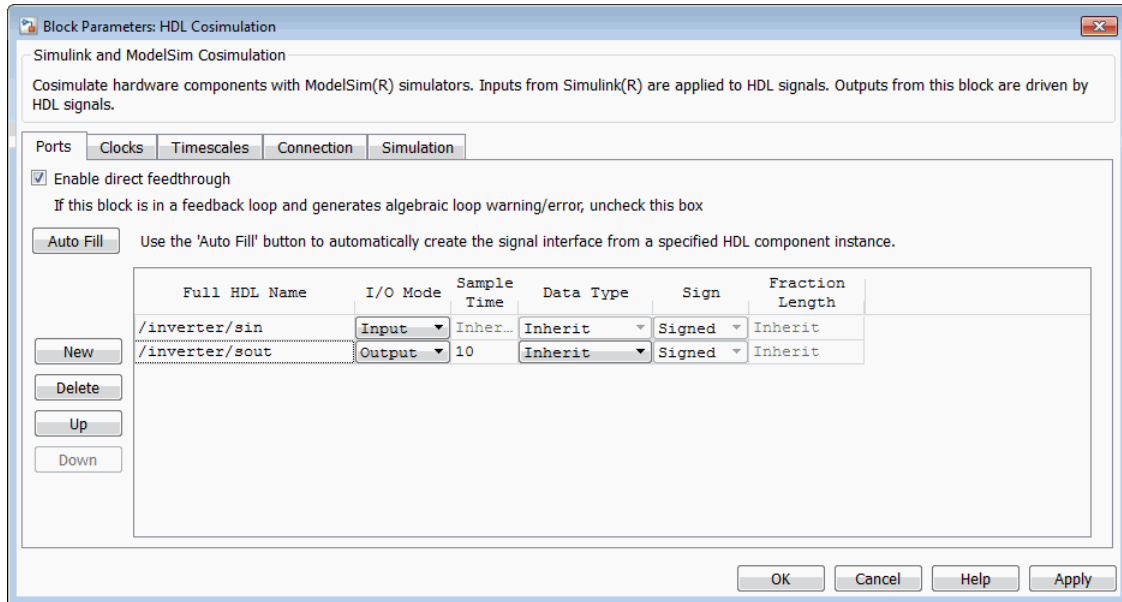

Now configure the parameters of the **Connection** pane by performing the following actions:

- 1 Click the **Connection** tab.
- 2 Leave **Connection Mode** as **Full Simulation**.
- 3 Select socket from the **Connection method** list. This option specifies that Simulink and ModelSim will communicate via a designated TCP/IP socket port. Observe that two additional fields, **Port number or service** and **Host name**, are now visible.

Note that, because **The HDL simulator is running on this computer option** is selected by default, the **Host name** field is disabled. In this configuration, both Simulink and ModelSim execute on the same computer, so you do not need to enter a remote host system name.

- 4 In the **Port number or service** text box, enter socket port number `4449` or, if this port is not available on your system, another valid port number or service name. The

model will use TCP/IP socket communication to link with ModelSim. Note what you enter for this parameter. You will specify the same socket port information when you set up ModelSim for linking with Simulink.

The **Connection** pane should appear as follows.

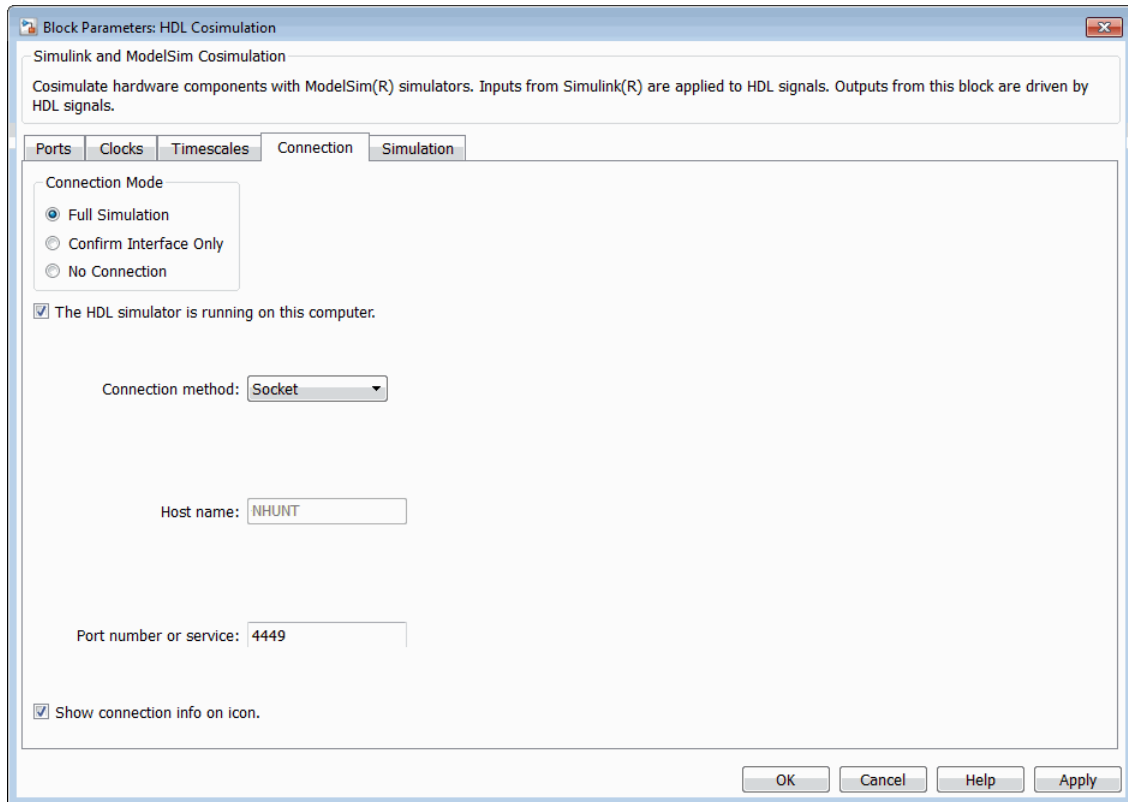

5 Click **Apply**.

Now configure the **Clocks** pane by performing the following actions:

- 1 Click the **Clocks** tab.
- 2 Click the **New** button. A new clock signal with an empty signal name is added to the signal list.
- 3 Double-click on the new signal name to edit. Enter the signal path `/inverter/clock`. Then select **Rising** from the **Edge** list. Set the **Period** parameter to 10.

4 The **Clocks** pane should appear as follows.

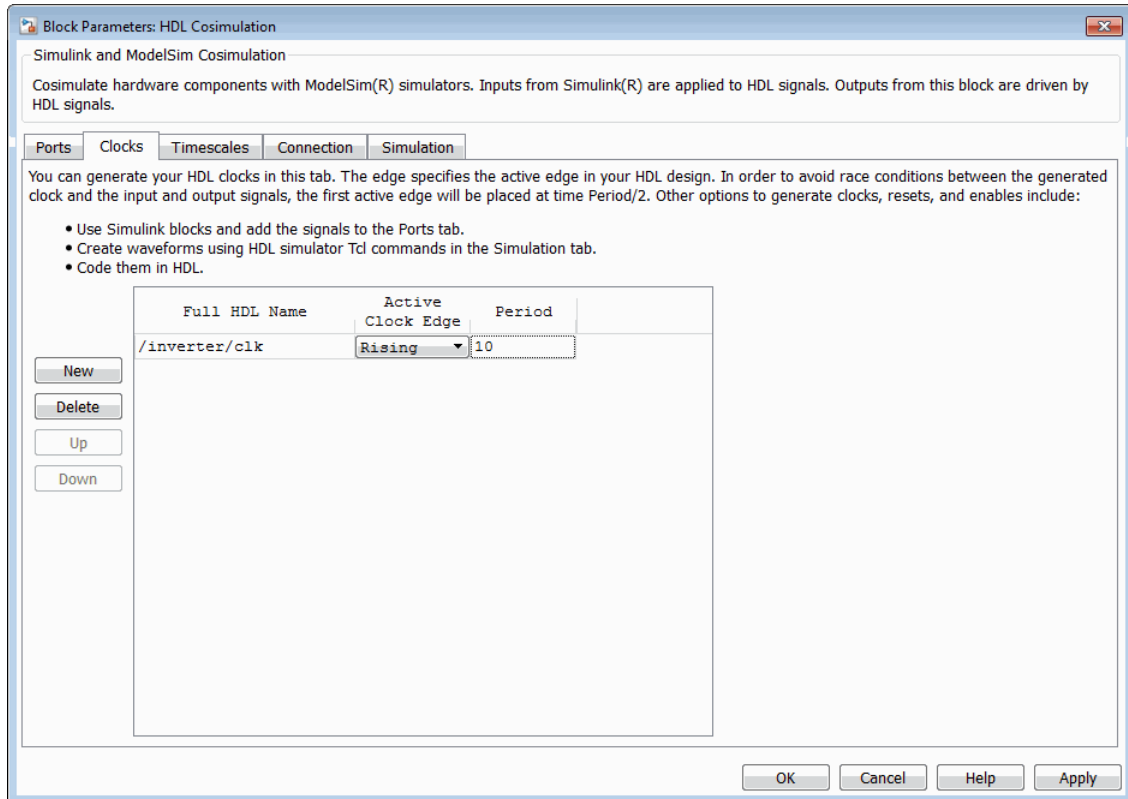

5 Click **Apply**.

Next, enter some simple Tcl commands to be executed before and after simulation, as follows:

- 1 Click the **Simulation** tab.
- 2 In the **Pre-simulation Tcl commands** text box, edit the default Tcl command:

```
puts "Running inverter in Simulink!"
```
- 3 In the **Post-simulation Tcl commands** text box, edit the default Tcl command:

```
puts "Inverter Done"
```

The **Simulation** pane should appear as follows.

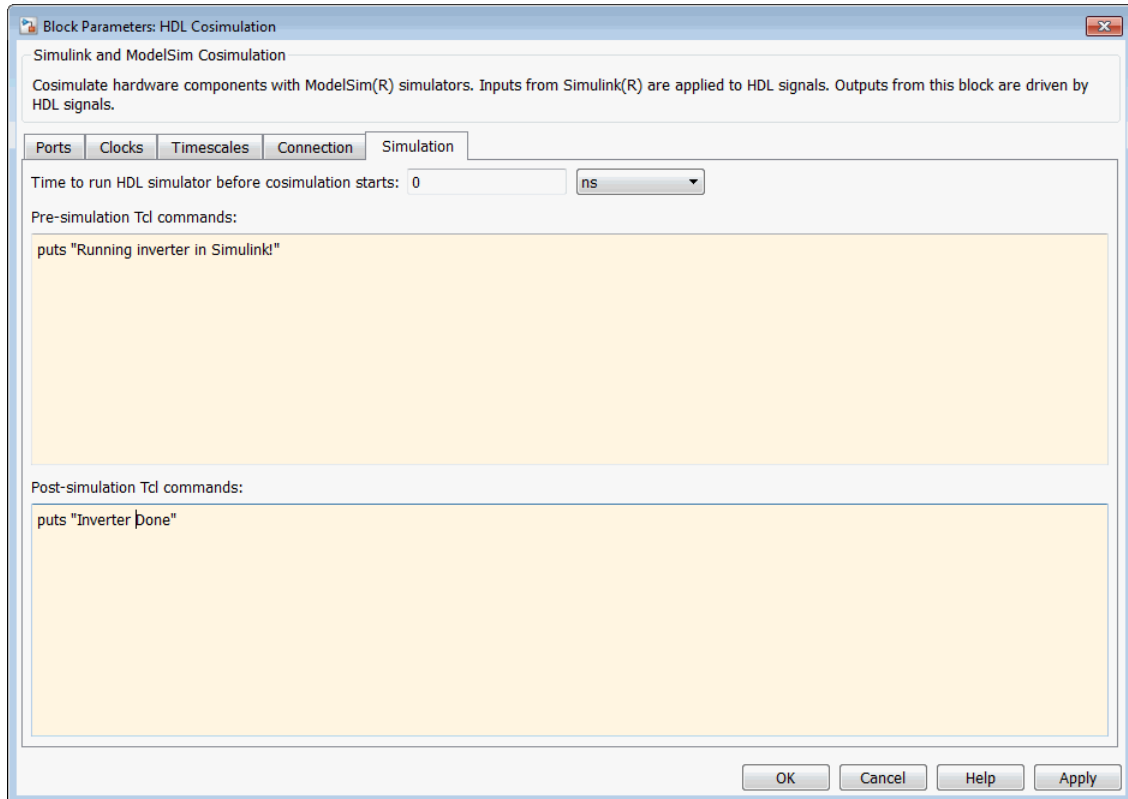

4 Click **Apply**.

Next, view the **Timescales** pane to make sure it is set to its default parameters, as follows:

- 1** Click the **Timescales** tab.
- 2** The default settings of the **Timescales** pane are shown in the following figure. These settings are required for operation of this example. See “Simulation Timescales” on page 8-57 for further information.

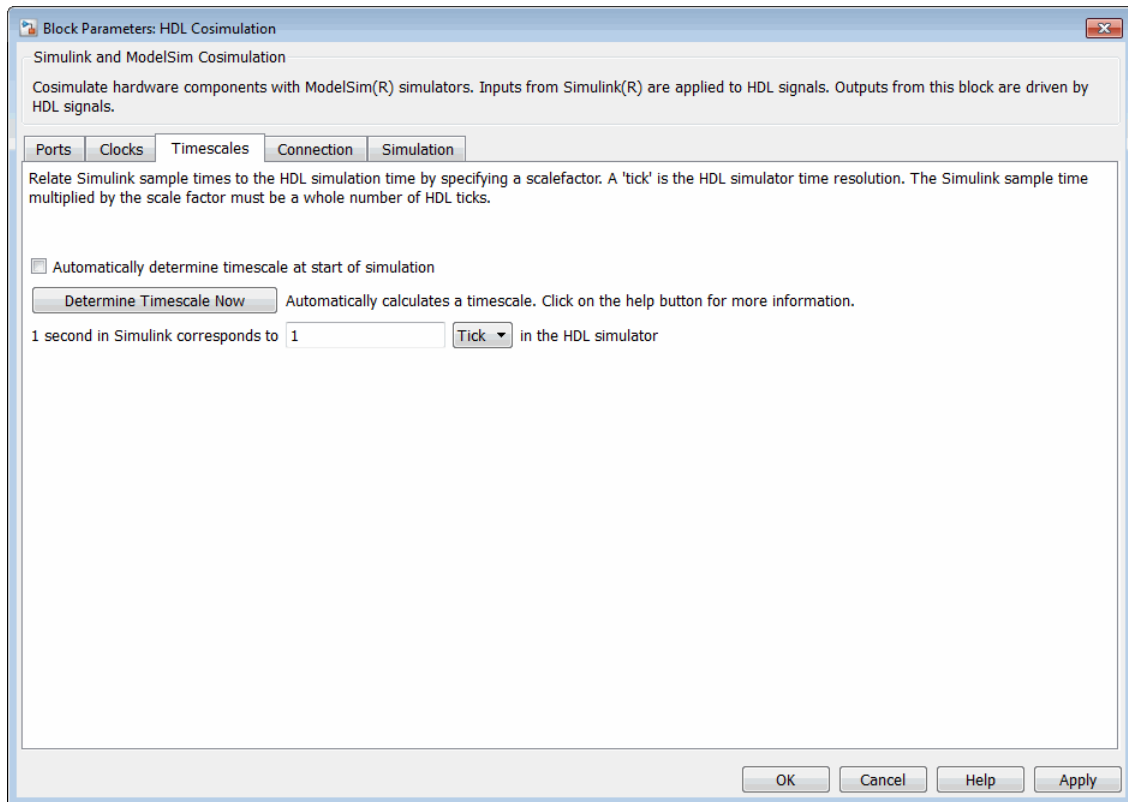

- 3 Click **OK** to close the **Block Parameters** dialog box.

The final step is to connect the blocks, configure model-wide parameters, and save the model. Perform the following actions:

- 1 Connect the blocks as shown in the following figure.

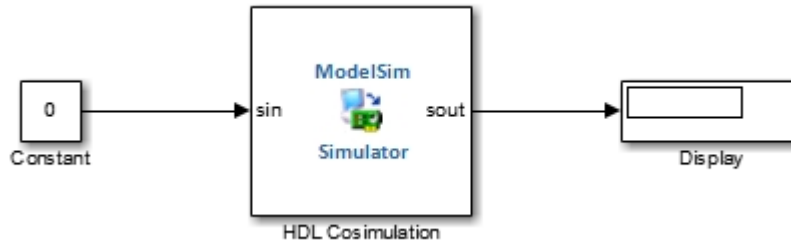

At this point, you might also want to consider adjusting block annotations.

- 2 Configure the Simulink solver options for a fixed-step, discrete simulation; this is required for cosimulation operation. Perform the following actions:
 - a Select **Model Configuration Parameters** from the **Simulation** menu in the model window. The **Model Configuration Parameters** dialog box opens, displaying the **Solver options** pane.
 - b Select **Fixed-step** from the **Type** menu.
 - c Select **discrete (no continuous states)** from the **Solver** menu.
 - d Click **Apply**.
 - e Click **OK** to close the **Model Configuration Parameters** dialog box.

See “Set Simulink Model Configuration Parameters” on page 4-42 for further information on Simulink settings that are optimal for use with HDL Verifier software.

- 3 Save the model.

Set Up ModelSim for Use with Simulink

You now have a VHDL representation of an inverter and a Simulink model that applies the inverter. To start ModelSim such that it is ready for use with Simulink, enter the following command line in the MATLAB Command Window:

```
vsim('socketsimulink', 4449)
```

Note: If you entered a different socket port specification when you configured the HDL Cosimulation block in Simulink, replace the port number 4449 in the preceding

command line with the applicable socket port information for your model. The `vsim` function informs ModelSim of the TCP/IP socket to use for establishing a communication link with your Simulink model.

Load Instances of VHDL Entity for Cosimulation with Simulink

This section explains how to use the `vsimulink` command to load an instance of your VHDL entity for cosimulation with Simulink. The `vsimulink` command is an HDL Verifier variant of the ModelSim `vsim` command. It is made available as part of the ModelSim configuration.

To load an instance of the `inverter` entity, perform the following actions:

- 1 Change your input focus to the ModelSim window.
- 2 If your VHD file is not in the current folder, change your folder to the location of your `inverter.vhd` file. For example:

```
ModelSim> cd C:/MyPlayArea
```

- 3 Enter the following `vsimulink` command:

```
ModelSim> vsimulink work.inverter
```

ModelSim starts the `vsim` simulator such that it is ready to simulate entity `inverter` in the context of your Simulink model. The ModelSim command window display should be similar to the following.

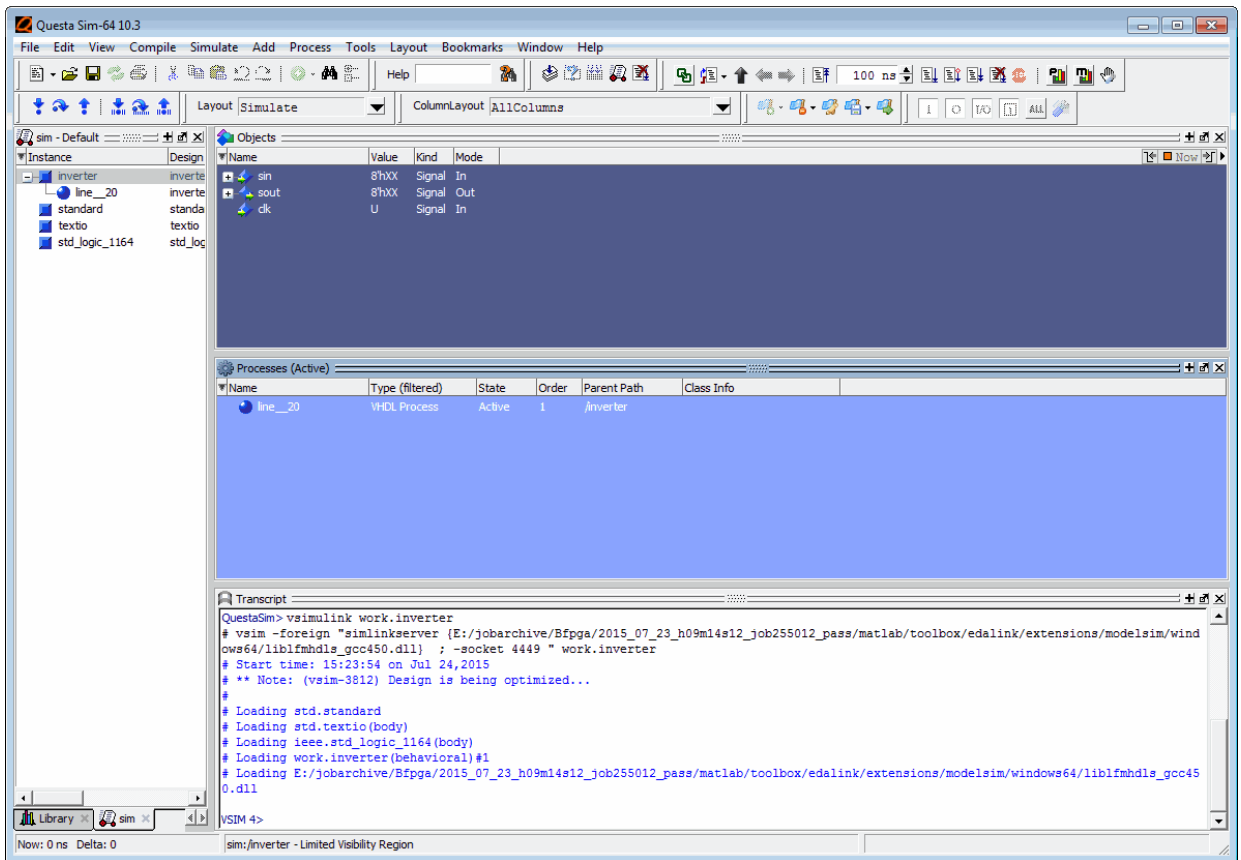

Run Simulation

This section guides you through a scenario of running and monitoring a cosimulation session.

Perform the following actions:

- 1 Open and add the inverter signals to a **wave** window by entering the following ModelSim command:

```
V$SIM n> add wave /inverter/*
```

The following **wave** window appears.

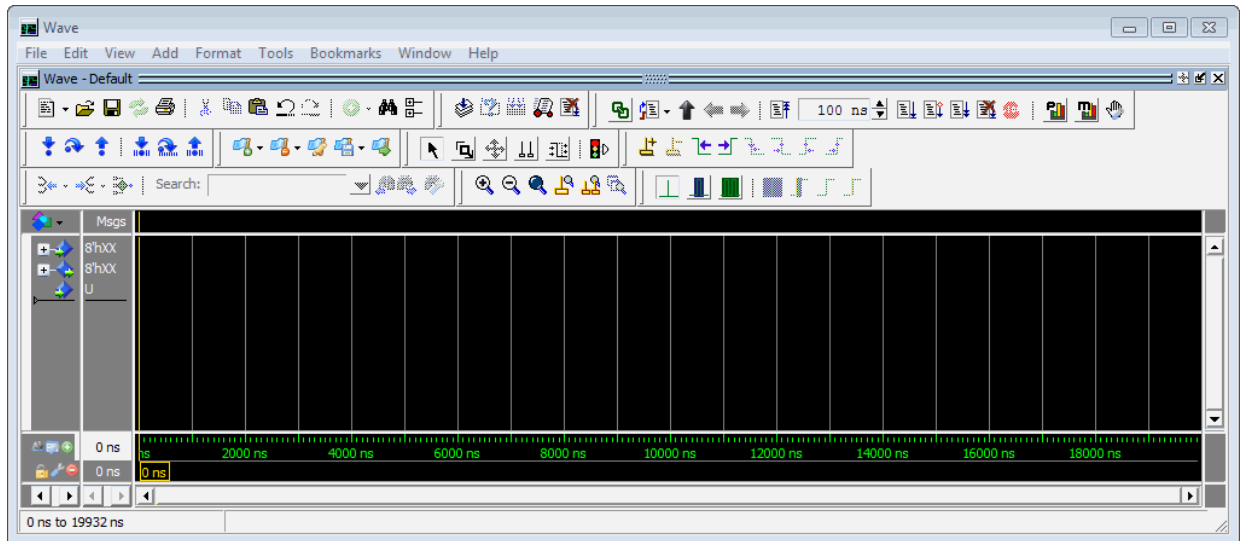

- 2 Change your input focus to your Simulink model window.
- 3 Start a Simulink simulation. The value in the `Display` block changes to 255. Also note the changes that occur in the ModelSim **wave** window. You might need to zoom in to get a better view of the signal data.

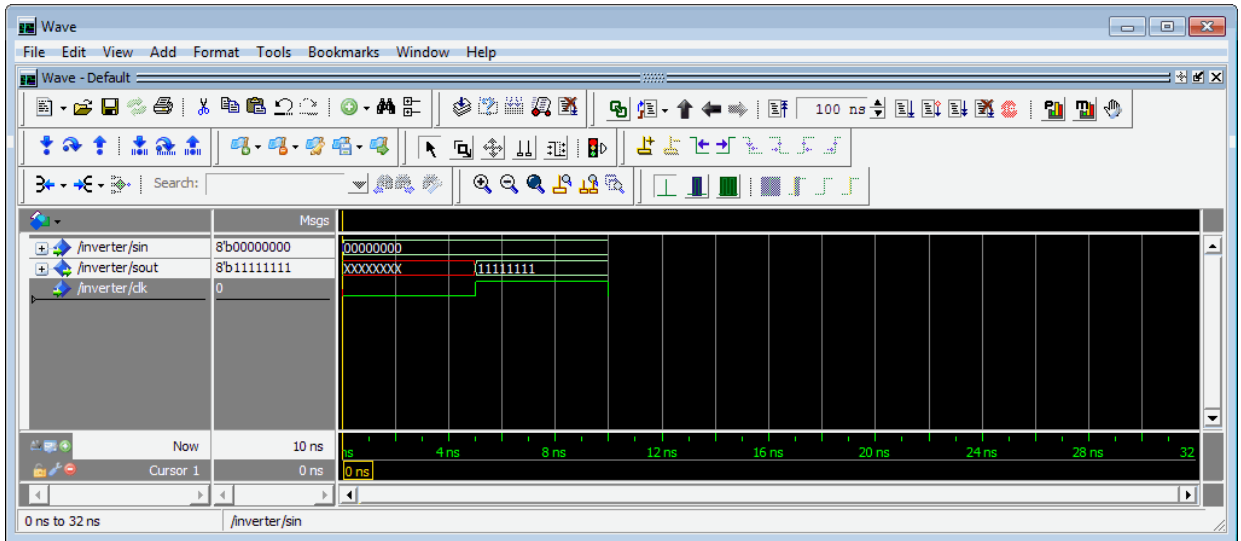

- 4 In the Simulink model, change **Constant** value to 255, save the model, and start another simulation. The value in the Display block changes to 0 and the ModelSim wave window is updated as follows.

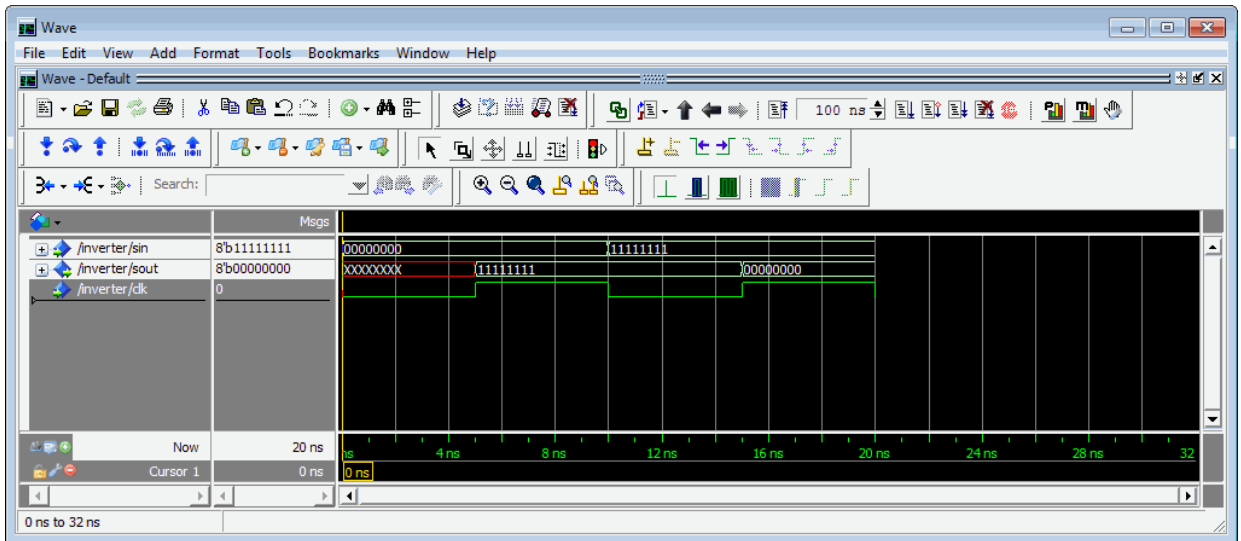

- 5 In the Simulink Model, change **Constant value** to 2 and **Sample time** to 20 and start another simulation. This time, the value in the **Display** block changes to 253 and the ModelSim **wave** window appears as shown in the following figure.

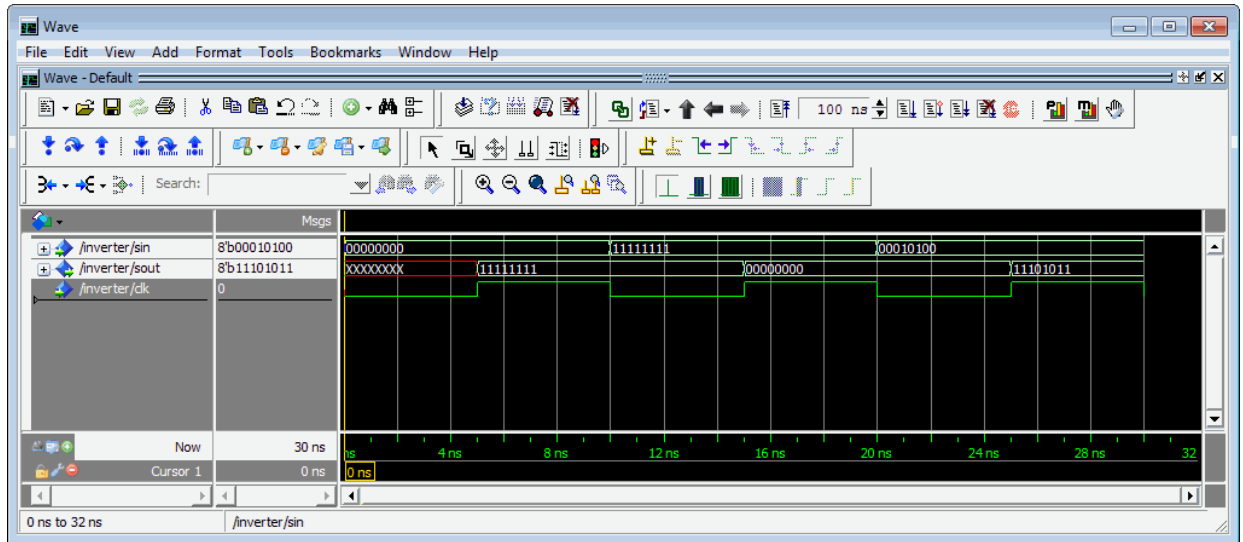

Note the change in the sample time in the **wave** window.

Shut Down Simulation

This section explains how to shut down a simulation in an orderly way, as follows:

- 1 In ModelSim, stop the simulation by selecting **Simulate > End Simulation**.
- 2 Quit ModelSim.
- 3 Close the Simulink model window.

Test Bench Automatic Verification with Simulink

The automatic verification feature integrates verification as part of the workflow for HDL Cosimulation using the HDL Workflow Advisor. During this workflow, Simulink generates a test bench model for HDL Cosimulation. This test bench model compares the generated HDL DUT outputs (coming through the HDL Cosimulation block) with the original Simulink block outputs. The automatic verification step automatically runs this test bench. This step returns pass/fail information depending if the outputs of the HDL DUT match the output of original Simulink block in the test bench.

- 1 Open HDL Workflow Advisor for your model.
- 2 Step 1.1, select **Generic ASIC/FPGA**.
- 3 Run all steps under 2, **Prepare Model For HDL Code Generation**.
- 4 At step 3.2, **Generate RTL Code and Testbench**, select **Generate cosimulation model (requires HDL Verifier)**. Then select either **Mentor Graphics ModelSim** or **Cadence Incisive** for your HDL simulator. Selecting these options causes step 3.3 to appear.

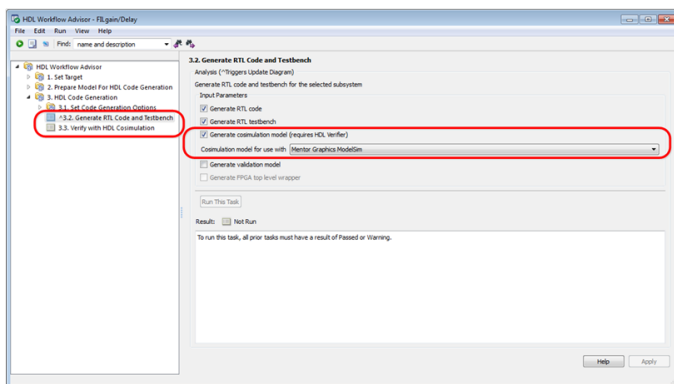

- 5 At step 3.3, click **Run This Task**. The HDL Workflow Advisor and HDL Verifier verify the generated HDL using cosimulation between the HDL Simulator and the Simulink test bench. Any relevant status messages are displayed in the status window in the HDL Workflow Advisor.

4 Simulink Test Bench for HDL Component

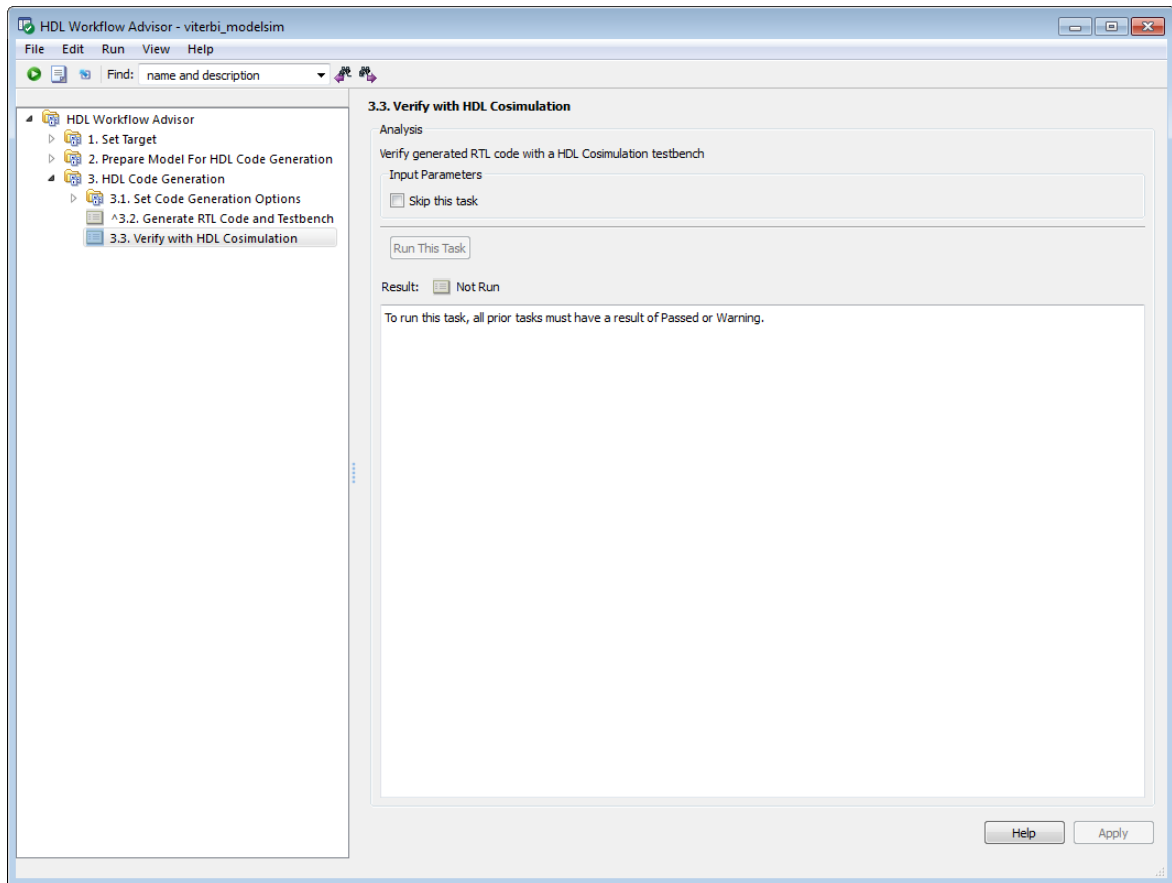

Replace HDL Component with Simulink Algorithm

- “Component Simulation with Simulink” on page 5-2
- “Replace HDL Component with Simulink Algorithm” on page 5-6
- “Code an HDL Component” on page 5-7
- “Create Simulink Model for Component Cosimulation” on page 5-10
- “Start HDL Simulator” on page 5-11
- “Add HDL Cosimulation Block to Model” on page 5-13
- “Define HDL Cosimulation Block Interface” on page 5-15
- “Run a Component Cosimulation Session” on page 5-41

Component Simulation with Simulink

In this section...

“How the HDL Simulator and Simulink Software Communicate Using HDL Verifier For Component Simulation” on page 5-2

“HDL Cosimulation Block Features for Component Simulation” on page 5-4

How the HDL Simulator and Simulink Software Communicate Using HDL Verifier For Component Simulation

When you link the HDL simulator with a Simulink application, the simulator functions as the server. As the following diagram shows, the HDL Cosimulation blocks inside the Simulink model accept signals from the HDL module under simulation in the HDL simulator via the output ports on the Ports panes and return data via the input ports on the Ports panes.

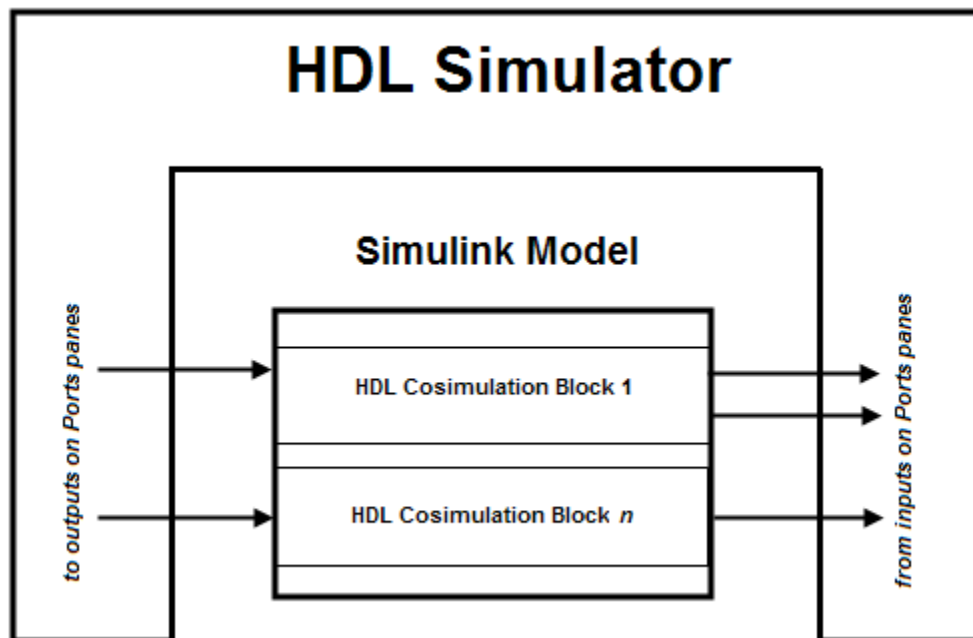

How Simulink Drives Cosimulation Signals

Although you can bind the output ports of an HDL `Cosimulation` block to any signal in an HDL model hierarchy, you must use some caution when connecting signals to input ports. You want to verify that the signal you are binding to does not have other drivers. If it does, use resolved logic types; otherwise you may get unpredictable results.

If you need to use a signal that has multiple drivers and it is resolved (for example, it is of VHDL type `STD_LOGIC`), Simulink applies the resolution function at each time step defined by the signal's Simulink sample rate. Depending on the other drivers, the Simulink value may or may not get applied. Furthermore, Simulink has no control over signal changes that occur between its sample times.

Note: Verify that signals used in cosimulation have read/write access. You can check read/write access through the HDL simulator—see HDL simulator documentation for details.

This rule applies to all signals on the **Ports**, **Clocks**, and **Simulation** panes and to signals added to the model in any other manner.

Multirate Signals During Component Cosimulation

HDL Verifier software supports the use of multirate signals, signals that are sampled or updated at different rates, in a single HDL `Cosimulation` block. An HDL `Cosimulation` block exchanges data for each signal at the Simulink sample rate for that signal. For input signals, an HDL `Cosimulation` block accepts and honors all signal rates.

The HDL `Cosimulation` block also lets you specify an independent sample time for each output port. You must explicitly set the sample time for each output port, or accept the default. Using this setting lets you control the rate at which Simulink updates an output port by reading the corresponding signal from the HDL simulator.

Continuous Time Signals

Use the Simulink `Zero-Order Hold` block to apply a zero-order hold (ZOH) on continuous signals that are driven into an HDL `Cosimulation` block.

HDL Cosimulation Block Features for Component Simulation

The HDL Verifier HDL Cosimulation Block links hardware components that are concurrently simulating in the HDL simulator to the rest of a Simulink model.

You can link Simulink and the HDL simulator in two possible ways:

- As a single HDL Cosimulation block fitted into the framework of a larger system-oriented Simulink model.
- As a Simulink model made up of a collection of HDL Cosimulation blocks, each representing a specific hardware component.

The block mask contains panels for entering port and signal information, setting communication modes, adding clocks (Incisive and ModelSim only), specifying pre- and post-simulation Tcl commands (Incisive and ModelSim only), and defining the timing relationship.

After you code one of your model's components in VHDL or Verilog and simulate it in the HDL simulator environment, you integrate the HDL representation into your Simulink model as an HDL Cosimulation block. There is one block for each supported HDL simulator. These blocks are located in the Simulink Library, within the HDL Verifier block library. As an example, the block for use with Mentor Graphics ModelSim is shown in the next figure.

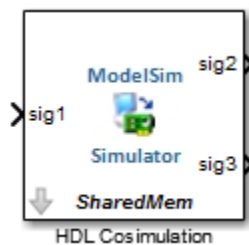

You configure an HDL Cosimulation block by specifying values for parameters in a block parameters dialog box. The HDL Cosimulation block parameters dialog box consists of tabbed panes that specify the following information:

- **Ports Pane:** Block input and output ports that correspond to signals, including internal signals, of your HDL design, and an output sample time.
- **Connection Pane:** Type of communication and related settings to be used for exchanging data between simulators.

- **Timescales Pane:** The timing relationship between Simulink software and the HDL simulator.
- **Clocks Pane** (Incisive and ModelSim only): Optional rising-edge and falling-edge clocks to apply to your model.
- **Simulation Pane** (Incisive and ModelSim only): Tcl commands to run before and after a simulation.

Replace HDL Component with Simulink Algorithm

The following workflow steps describe how to cosimulate an HDL design that tests the algorithm being modeled with the Simulink software.

- 1** Create, compile, and elaborate HDL design. See “Code an HDL Component” on page 5-7.
- 2** Design algorithm and model algorithm in Simulink. See “Create Simulink Model for Component Cosimulation” on page 5-10.
- 3** Start HDL simulator for use with MATLAB and Simulink and load HDL Verifier libraries. See “Start HDL Simulator” on page 5-11.
- 4** Add one or more HDL Cosimulation blocks to provide communication between simulators. See “Add HDL Cosimulation Block to Model” on page 5-13.
- 5** Define HDL Cosimulation block interfaces. See “Define HDL Cosimulation Block Interface” on page 5-15.
- 6** Start simulation in Simulink. See “Run a Component Cosimulation Session” on page 5-41.
- 7** Run cosimulation in HDL simulator. See “Run a Component Cosimulation Session” on page 5-41.

Code an HDL Component

In this section...

“Overview to Coding HDL Modules for Simulink Component Simulation” on page 5-7

“Specify Port Direction Modes in HDL Module for Component Simulation” on page 5-7

“Specify Port Data Types in HDL Module for Component Simulation” on page 5-7

“Compile and Elaborate HDL Design for Component Simulation” on page 5-9

Overview to Coding HDL Modules for Simulink Component Simulation

The HDL Verifier interface passes all data between the HDL simulator and Simulink as port data. The HDL Verifier software works with any existing HDL module. However, when you code an HDL module that is targeted for Simulink verification, you should consider the types of data to be shared between the two environments and the direction modes.

Specify Port Direction Modes in HDL Module for Component Simulation

In your module statement, you must specify each port with a direction mode (input, output, or bidirectional). The following table defines these three modes.

Use VHDL Mode...	Use Verilog Mode...	For Ports That...
IN	input	Represent signals that can be driven by a MATLAB function
OUT	output	Represent signal values that are passed to a MATLAB function
INOUT	inout	Represent bidirectional signals that can be driven by or pass values to a MATLAB function

Specify Port Data Types in HDL Module for Component Simulation

This section describes how to specify data types compatible with MATLAB for ports in your HDL modules. For details on how the HDL Verifier interface converts data types for the MATLAB environment, see “Data Type Conversions” on page 8-49.

Note: If you use unsupported types, the HDL Verifier software issues a warning and ignores the port at run time. For example, if you define your interface with five ports, one of which is a VHDL access port, at run time, then the interface displays a warning and your code sees only four ports.

Port Data Types for VHDL Entities

In your entity statement, you must define each port that you plan to test with MATLAB with a VHDL data type that is supported by the HDL Verifier software. The interface can convert scalar and array data of the following VHDL types to comparable MATLAB types:

- STD_LOGIC, STD_ULOGIC, BIT, STD_LOGIC_VECTOR, STD_ULOGIC_VECTOR, and BIT_VECTOR
- INTEGER and NATURAL
- REAL
- TIME
- Enumerated types, including user-defined enumerated types and CHARACTER

The interface also supports all subtypes and arrays of the preceding types.

Note: The HDL Verifier software does not support VHDL extended identifiers for the following components:

- Port and signal names used in cosimulation
- Enum literals when used as array indices of port and signal names used in cosimulation

However, the software does support basic identifiers for VHDL.

Port Data Types for Verilog Modules

In your module definition, you must define each port that you plan to test with MATLAB with a Verilog port data type that is supported by the HDL Verifier software. The interface can convert data of the following Verilog port types to comparable MATLAB types:

- reg

- integer
- wire

Note: HDL Verifier software does not support Verilog escaped identifiers for port and signal names used in cosimulation. However, it does support simple identifiers for Verilog.

Compile and Elaborate HDL Design for Component Simulation

Refer to the HDL simulator documentation for instruction in compiling and elaborating the HDL design.

Create Simulink Model for Component Cosimulation

In this section...
“Simulink Model for Component Cosimulation” on page 5-10
“Run and Test Component Hardware Model in Simulink” on page 5-10
“Add Value Change Dump (VCD) File to Component Model (Optional)” on page 5-10

Simulink Model for Component Cosimulation

For the most part, there is nothing different about creating a Simulink model to act as an HDL component than there is from creating a Simulink model to use as a test bench. When using Simulink as a component, you may have multiple HDL Cosimulation blocks rather than a single HDL Cosimulation block, though there's no limitation on how many HDL Cosimulation blocks you may use in either situation.

Create a Simulink test bench model by adding Simulink blocks from the Simulink Block libraries. For help with creating a Simulink model, see the Simulink documentation.

Run and Test Component Hardware Model in Simulink

If you design a Simulink model first, run and test your model thoroughly before replacing or adding hardware model components as HDL Verifier Cosimulation blocks.

Add Value Change Dump (VCD) File to Component Model (Optional)

You might want to add a VCD file to log changes to variable values during a simulation session. See “Add a Value Change Dump (VCD) File” on page 6-2 for instructions on adding the To VCD File block.

Start HDL Simulator

In this section...

“Start HDL Simulator from MATLAB” on page 5-11

“Load Instance of HDL Module for Component Cosimulation” on page 5-11

Start HDL Simulator from MATLAB

Start the HDL simulator directly from MATLAB by calling the HDL Verifier function `vsim` or `nclaunch`.

```
>>vsim
```

Note that if both tools (MATLAB and the HDL simulator) are not running on the same system, you must start the HDL simulator manually and load the HDL Verifier libraries yourself. See “HDL Verifier Libraries” on page 8-10.

You can call `vsim` or `nclaunch` with additional parameters; see the reference pages for details.

You must make sure the HDL simulator executables — also called `vsim` (ModelSim) and `nclaunch` (Cadence Incisive) — are on the system path. See your system documentation for instruction on setting environment variables.

Linux Users Make sure the HDL simulator executable is still on the system path after the shell is launched from MATLAB. If it is not, make sure the shell startup file does not remove it from the path environment variable.

Load Instance of HDL Module for Component Cosimulation

Incisive users load an instance of the HDL module for cosimulation using the `hdlsimulink` function. ModelSim users do the same using the `vsimulink` function.

Example of loading HDL Module instance — Incisive users

After you start the HDL simulator from MATLAB, load an instance of an HDL module for cosimulation with the function `hdlsimulink`. Issue the command for each instance of an HDL module in your model that you want to cosimulate.

For example:

```
hdlsimulink work.manchester
```

Example of loading HDL Module instance — ModelSim users

After you start the HDL simulator from MATLAB, load an instance of an HDL module for cosimulation with the function `vsimulink`. Issue the command for each instance of an HDL module in your model that you want to cosimulate.

For example:

```
vsimulink work.manchester
```

This command opens a simulation workspace for `manchester` and displays a series of messages in the HDL simulator command window as the simulator loads the packages and architectures for the HDL module.

Add HDL Cosimulation Block to Model

In this section...

“Insert HDL Cosimulation Block” on page 5-13

“Connect Block Ports” on page 5-14

Insert HDL Cosimulation Block

After you code one of your model's components in VHDL or Verilog and simulate it in the HDL simulator environment, integrate the HDL representation into your Simulink model as an HDL Cosimulation block by performing the following steps:

- 1 Open your Simulink model, if it is not already open.
- 2 Delete the model component that the HDL Cosimulation block is to replace.
- 3 In the Simulink Library Browser, click the HDL Verifier block library. You can then select the block library for your supported HDL simulator. Select either the Mentor Graphics ModelSim HDL Cosimulation block, or the Cadence Incisive HDL Cosimulation block, as shown below.

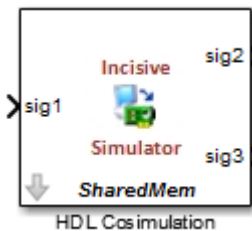
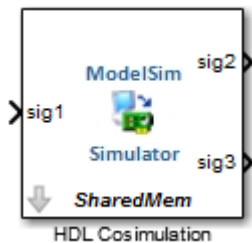

- 4 Copy the HDL Cosimulation block icon from the Library Browser to your model. Simulink creates a link to the block at the point where you drop the block icon.

Connect Block Ports

Connect any HDL Cosimulation block ports to the applicable block ports in your Simulink model.

- To model a sink device, configure the block with inputs only.
- To model a source device, configure the block with outputs only.

Define HDL Cosimulation Block Interface

In this section...

“Open HDL Cosimulation Block Interface” on page 5-15

“Map HDL Signals to Block Ports” on page 5-16

“Specify Signal Data Types” on page 5-31

“Configure Simulink and HDL Simulator Timing Relationship” on page 5-31

“Configure Communication Link in the HDL Cosimulation Block” on page 5-34

“Specify Pre- and Post-Simulation Tcl Commands with HDL Cosimulation Block Parameters Dialog Box” on page 5-36

“Programmatically Control Block Parameters” on page 5-39

Open HDL Cosimulation Block Interface

To open the block parameters dialog box for the HDL `Cosimulation` block, double-click the block icon. Simulink displays the following Block Parameters dialog box (as an example, the dialog box for the HDL `Cosimulation` block for use with ModelSim is shown below).

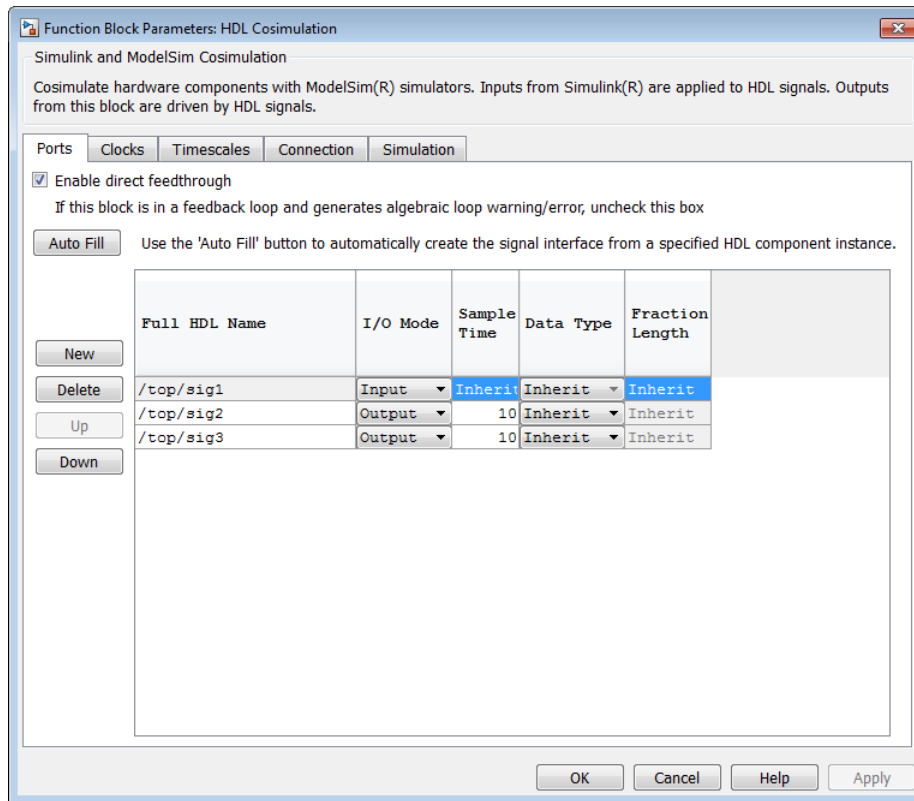

Map HDL Signals to Block Ports

- “Specify HDL Signal/Port and Module Paths for Cosimulation” on page 5-17
- “Get Signal Information from the HDL Simulator” on page 5-19
- “Enter Signal Information Manually” on page 5-25
- “Import Signal Information Directly by Value of Input Port” on page 5-30

The first step to configuring your HDL Verifier Cosimulation block is to map signals and signal instances of your HDL design to port definitions in your HDL Cosimulation block. In addition to identifying input and output ports, you can specify a sample time for each output port. You can also specify a fixed-point data type for each output port.

The signals that you map can be at any level of the HDL design hierarchy.

To map the signals, you can perform either of the following actions:

- Enter signal information manually into the **Ports** pane of the HDL Cosimulation Block Parameters dialog box. This approach can be more efficient when you want to connect a small number of signals from your HDL model to Simulink. See “Enter Signal Information Manually” on page 4-26.
- Use the **Auto Fill** button to have the HDL Cosimulation block obtain signal information for you by transmitting a query to the HDL simulator. This approach can save significant effort when you want to cosimulate an HDL model that has many signals that you want to connect to your Simulink model. However, in some cases, you will need to edit the signal data returned by the query. See “Get Signal Information from HDL Simulator” on page 4-20 for details.

Note: Verify that signals used in cosimulation have read/write access. For higher performance, you want to provide access only to those signals used in cosimulation. This rule applies to all signals on the **Ports**, **Clocks**, and **Simulation** panes, and to all signals added in any other manner.

Specify HDL Signal/Port and Module Paths for Cosimulation

These rules are for signal/port and module path specifications in Simulink. Other specifications may work but are not explicitly or implicitly supported in this or future releases.

HDL designs generally do have hierarchy; that is the reason for this syntax. This specification does not represent a file name hierarchy.

Path specifications must follow the rules listed in the following sections:

- “Path Specifications for Simulink Cosimulation Sessions with Verilog Top Level” on page 4-18
- “Path Specifications for Simulink Cosimulation Sessions with VHDL Top Level” on page 4-19

Path Specifications for Simulink Cosimulation Sessions with Verilog Top Level

- Path specification must start with a top-level module name.
- Path specification can include "." or "/" path delimiters, but cannot include a mixture.
- The leaf module or signal must match the HDL language of the top-level module.

The following examples show valid signal and module path specifications:

```
top.port_or_sig
/top/sub/port_or_sig
top
top/sub
top.sub1.sub2
```

The following examples show *invalid* signal and module path specifications:

- top.sub/port_or_sig

Why this specification is invalid: You cannot use mixed delimiters.

- :sub:port_or_sig

:

:sub

Why this specification is invalid: When you use VHDL-specific delimiters you limit the interoperability with paths when moving between HDL simulators and between VHDL and Verilog.

Path Specifications for Simulink Cosimulation Sessions with VHDL Top Level

- Path specification may include the top-level module name but it is not required.
- Path specification can include "." or "/" path delimiters, but cannot include a mixture.
- The leaf module or signal must match the HDL language of the top-level module.

The following examples show valid signal and module path specifications:

```
top.port_or_sig
/sub/port_or_sig
top
top/sub
top.sub1.sub2
```

The following examples show *invalid* signal and module path specifications:

- top.sub/port_or_sig

Why this specification is invalid: You cannot use mixed delimiters.

- `:sub:port_or_sig`
`:`
`:sub`

Why this specification is invalid: When you use VHDL-specific delimiters you limit the interoperability with paths when moving between HDL simulators and between VHDL and Verilog.

Get Signal Information from the HDL Simulator

The **Auto Fill** button lets you begin an HDL simulator query and supply a path to a component or module in an HDL model under simulation in the HDL simulator. Usually, some change of the port information is required after the query completes. You must have the HDL simulator running with the HDL module loaded for **Auto Fill** to work.

The following example describes the required steps.

Note: The example is based on a modified copy of the Manchester Receiver model, in which all signals were first deleted from the **Ports** and **Clocks** panes.

- 1 Open the block parameters dialog box for the HDL Cosimulation block. Click the **Ports** tab. The **Ports** pane opens (as an example, the **Ports** pane for the HDL Cosimulation block for use with ModelSim is shown in the illustrations below).

5 Replace HDL Component with Simulink Algorithm

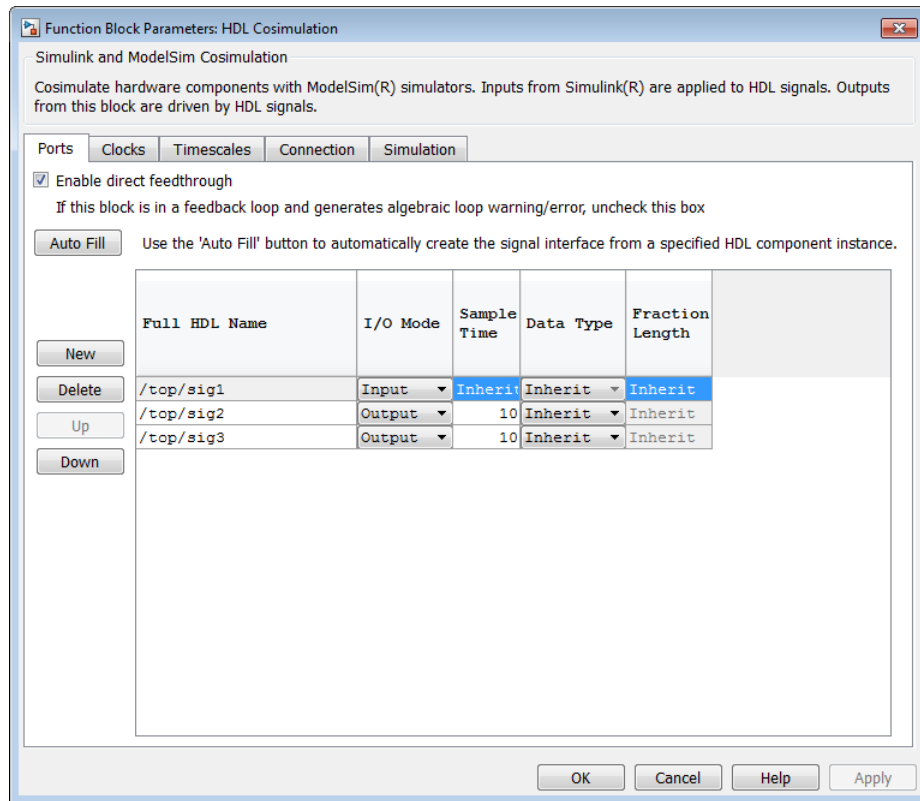

Tip Delete all ports before performing **Auto Fill** to make sure that no unused signal remains in the Ports list at any time.

- 2 Click the **Auto Fill** button. The **Auto Fill** dialog box opens.

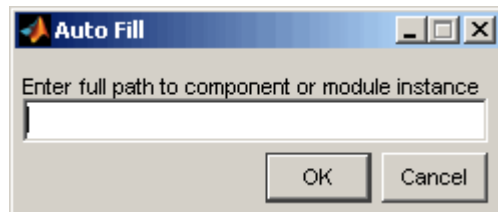

This modal dialog box requests an instance path to a component or module in your HDL model; here you enter an explicit HDL path into the edit field. The path you enter is not a file path and has nothing to do with the source files.

- 3 In this example, the Auto Fill feature obtains port data for a VHDL component called **manchester**. The HDL path is specified as `/top/manchester`. Path specifications will vary depending on your HDL simulator, see “Specify HDL Signal/Port and Module Paths for Cosimulation” on page 4-18.

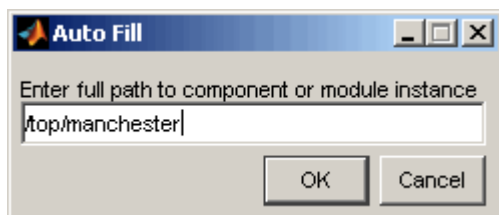

- 4 Click **OK** to dismiss the dialog box and the query is transmitted.
- 5 After the HDL simulator returns the port data, the Auto Fill feature enters it into the **Ports** pane, as shown in the following figure (examples shown for use with Cadence Incisive).

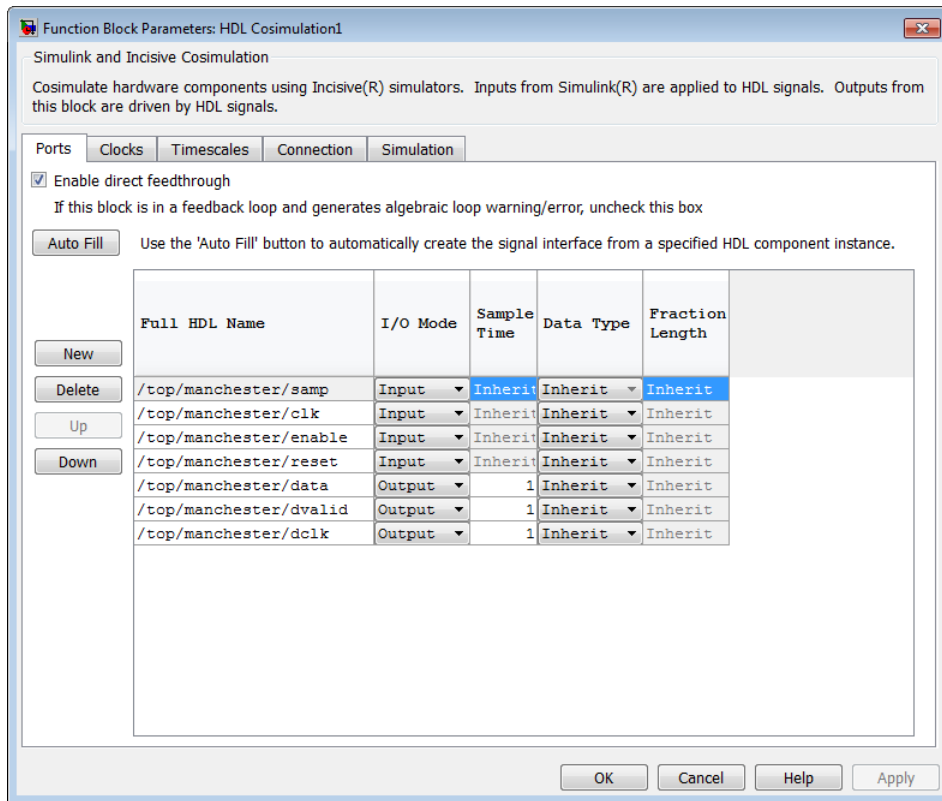

- 6 Click **Apply** to commit the port additions.
- 7 Delete unused signals from Ports pane and add Clock signal.

The preceding figure shows that the query entered clock, clock enable, and reset ports (labeled `clk`, `enable`, and `reset` respectively) into the ports list.

Delete the `enable` and `reset` signals from the **Ports** pane, and add the `clk` signal in the **Clocks** pane.

These actions result in the signals shown in the next figures.

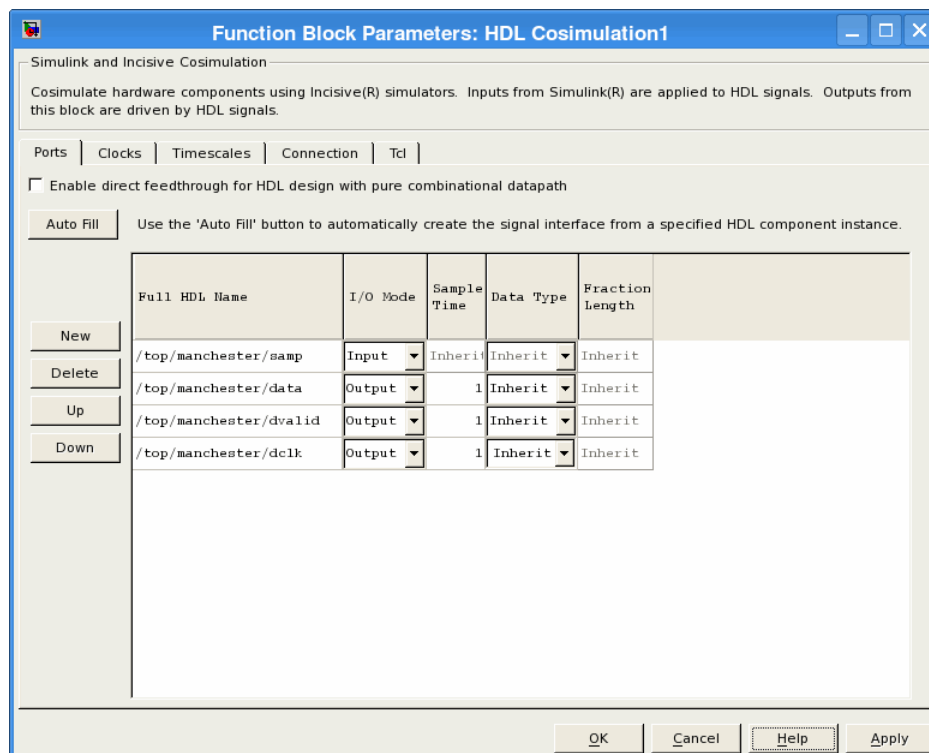

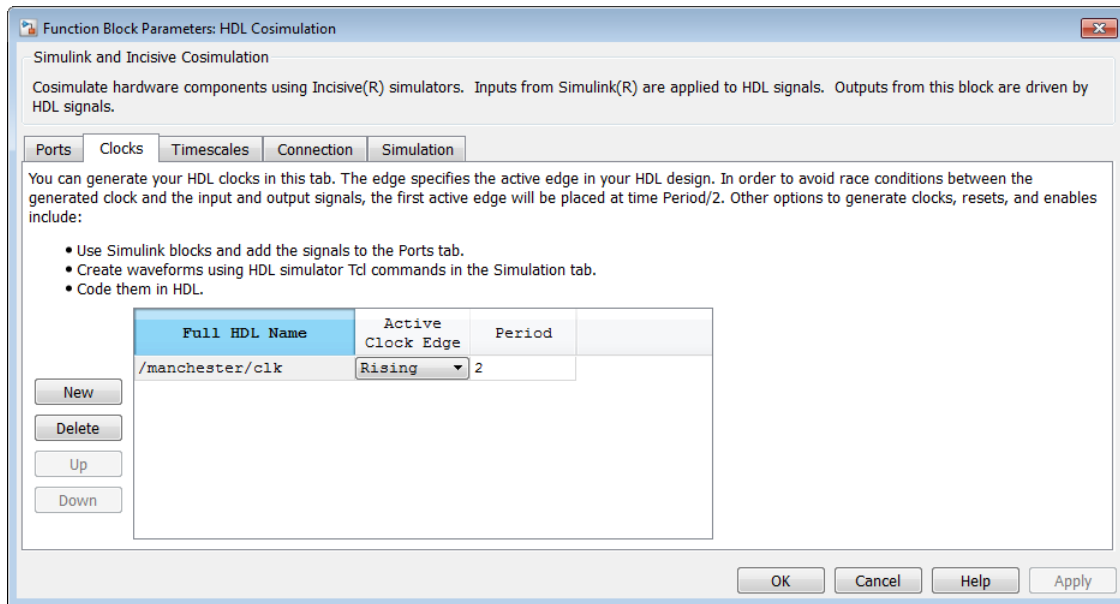

8 Auto Fill returns default values for output ports:

- **Sample time:** 1
- **Data type:** Inherit
- **Fraction length:** Inherit

You may need to change these values as required by your model. In this example, the **Sample time** should be set to 10 for all outputs. See also “Specify Signal Data Types” on page 4-32.

9 Before closing the HDL Cosimulation block parameters dialog box, click **Apply** to commit any edits you have made.

Observe that **Auto Fill** returned information about *all* inputs and outputs for the targeted component. In many cases, this will include signals that function in the HDL simulator but cannot be connected in the Simulink model. You may delete any such entries from the list in the **Ports** pane if they are unwanted. You *can* drive the signals from Simulink; you just have to define their values by laying down Simulink blocks.

Note that **Auto Fill** does not return information for internal signals. If your Simulink model needs to access such signals, you must enter them into the **Ports** pane manually.

For example, in the case of the Manchester Receiver model, you would need to add output port entries for `top/manchester/sync_i`, `top/manchester/isum_i`, and `top/manchester/qsum_i`, as shown in step 8.

Incisive and ModelSim users: Note that `clk`, `reset`, and `clk_enable` *may* be in the Clocks and Simulation panes but they don't *have* to be. These signals can be ports if you choose to drive them explicitly from Simulink.

Note: When you import VHDL signals using **Auto Fill**, the HDL simulator returns the signal names in all capitals.

Enter Signal Information Manually

To enter signal information directly in the **Ports** pane, perform the following steps:

- 1 In the HDL simulator, determine the signal path names for the HDL signals you plan to define in your block. For example, in the ModelSim simulator, the following wave window shows all signals are subordinate to the top-level module `manchester`.

5 Replace HDL Component with Simulink Algorithm

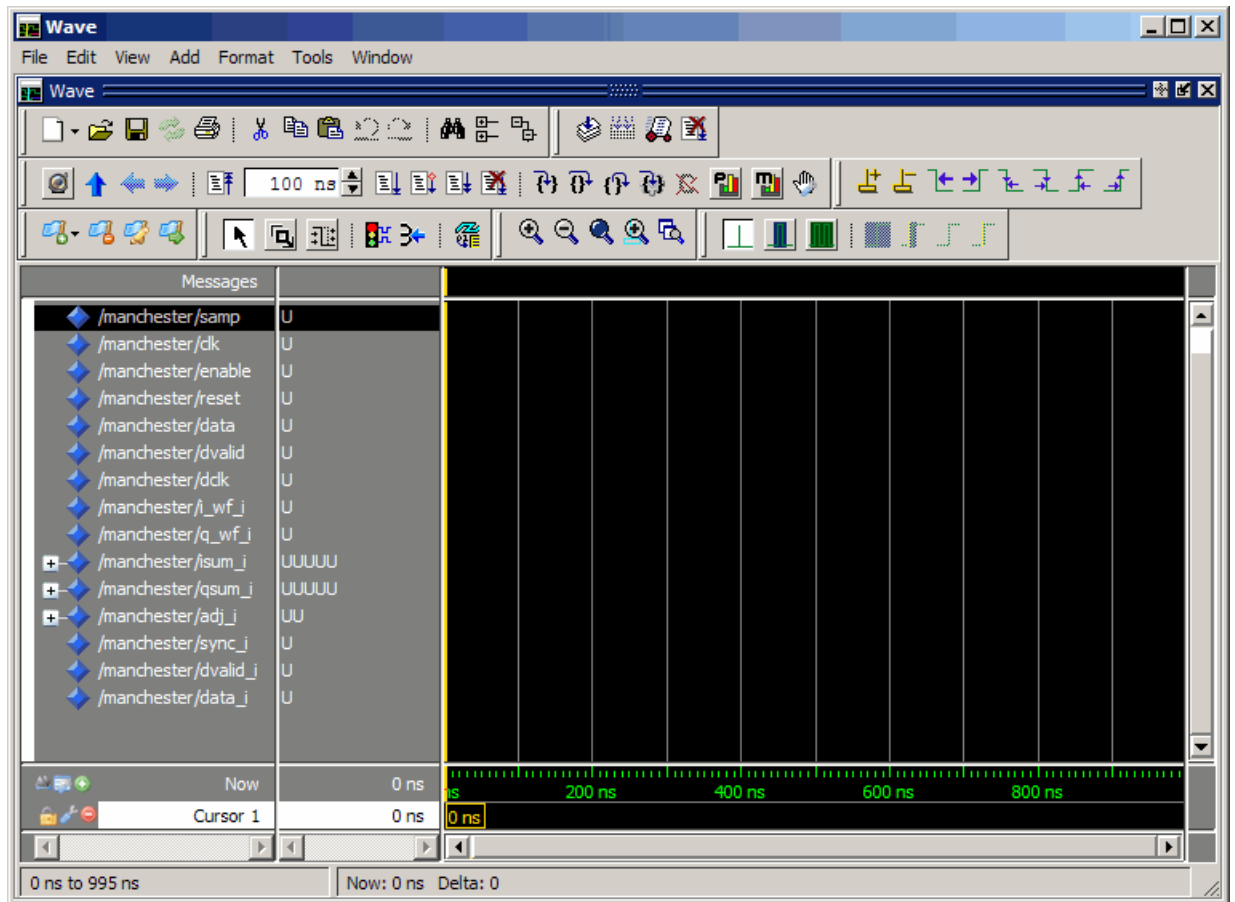

- 2 In Simulink, open the block parameters dialog box for your HDL Cosimulation block, if it is not already open.
- 3 Select the **Ports** pane tab. Simulink displays the following dialog box (example shown for use with Incisive).

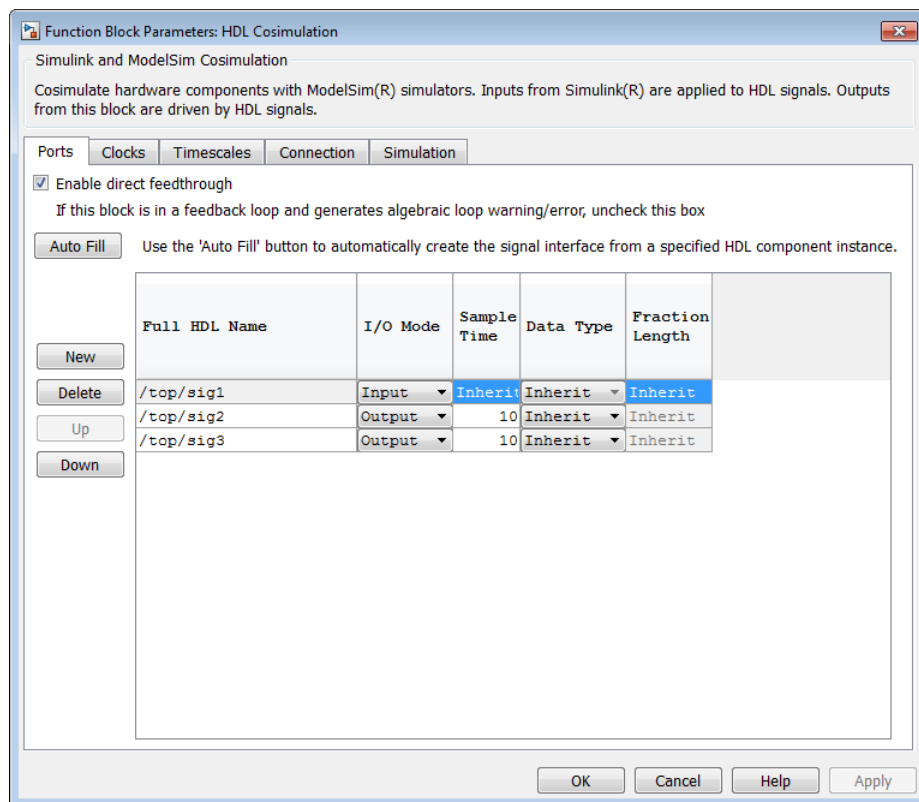

In this pane, you define the HDL signals of your design that you want to include in your Simulink block and set a sample time and data type for output ports. The parameters that you should specify on the **Ports** pane depend on the type of device the block is modeling as follows:

- For a device having both inputs and outputs: specify block input ports, block output ports, output sample times and output data types.

For output ports, accept the default or enter an explicit sample time. Data types can be specified explicitly, or set to `Inherit` (the default). In the default case, the output port data type is inherited either from the signal connected to the port, or derived from the HDL model.

- For a sink device: specify block output ports.

- For a source device: specify block input ports.
- 4** Enter signal path names in the **Full HDL name** column by double-clicking on the existing default signal.
- Use HDL simulator path name syntax (as described in “Specify HDL Signal/Port and Module Paths for MATLAB Test Bench Cosimulation” on page 1-22).
 - If you are adding signals, click **New** and then edit the default values. Select either **Input** or **Output** from the **I/O Mode** column.
 - If you want to, set the **Sample Time**, **Data Type**, and **Fraction Length** parameters for signals explicitly, as discussed in the remaining steps.

When you have finished editing clock signals, click **Apply** to register your changes with Simulink.

The following dialog box shows port definitions for an HDL **Cosimulation** block. The signal path names match path names that appear in the HDL simulator **wave** window (Incisive example shown).

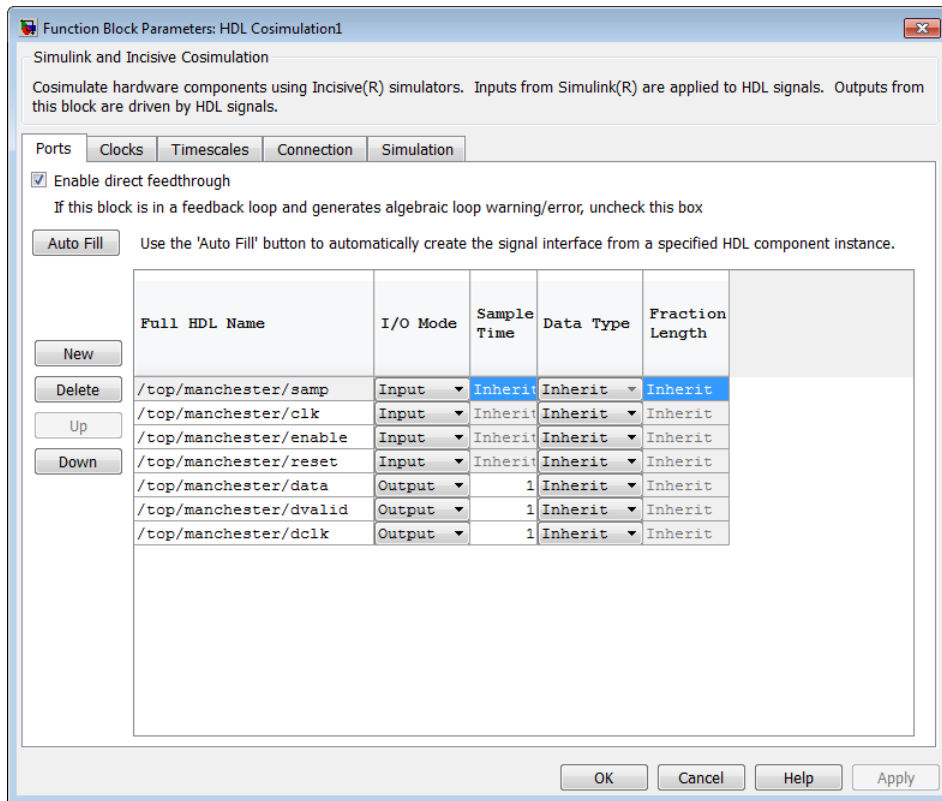

Note: When you define an input port, make sure that only one source is set up to force input to that port. If multiple sources drive a signal, your Simulink model may produce unpredictable results.

- 5 You must specify a sample time for the output ports. Simulink uses the value that you specify, and the current settings of the **Timescales** pane, to calculate an actual simulation sample time.

For more information on sample times in the HDL Verifier cosimulation environment, see “Simulation Timescales” on page 8-57.

- 6 You can configure the fixed-point data type of each output port explicitly if desired, or use a default (**Inherited**). In the default case, Simulink determines the data type for an output port as follows:

If Simulink can determine the data type of the signal connected to the output port, it applies that data type to the output port. For example, the data type of a connected Signal Specification block is known by back-propagation. Otherwise, Simulink queries the HDL simulator to determine the data type of the signal from the HDL module.

To assign an explicit fixed-point data type to a signal, perform the following steps:

- a Select either **Signed** or **Unsigned** from the **Data Type** column.
- b If the signal has a fractional part, enter the **Fraction Length**.

For example, if the model has an 8-bit signal with **Signed** data type and a **Fraction Length** of 5, the HDL Cosimulation block assigns it the data type `sfixed8_En5`. If the model has an **Unsigned** 16-bit signal with no fractional part (a **Fraction Length** of 0), the HDL Cosimulation block assigns it the data type `ufixed16`.

- 7 Before closing the dialog box, click **Apply** to register your edits.

Import Signal Information Directly by Value of Input Port

Enabling direct feedthrough allows input port value changes to propagate to the output ports in zero time, thus eliminating the possible delay at output sample in HDL designs with pure combinational logic. Specify the option to enable direct feedthrough on the **Ports** pane, as shown in the following figure.

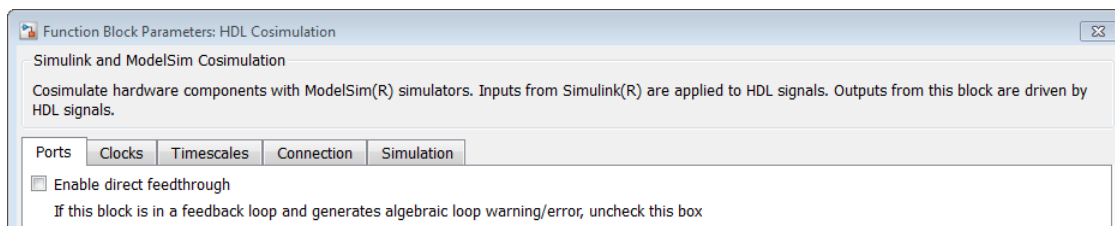

Specify Signal Data Types

The **Data Type** and **Fraction Length** parameters apply only to output signals. See **Data Type** and **Fraction Length** on the Ports pane description of the HDL Cosimulation block.

Configure Simulink and HDL Simulator Timing Relationship

You configure the timing relationship between Simulink and the HDL simulator by using the **Timescales** pane of the block parameters dialog box. Before setting the **Timescales** parameters, read “Simulation Timescales” on page 8-57 to understand the supported timing modes and the issues that will determine your choice of timing mode.

You can specify either a relative or an absolute timing relationship between Simulink and the HDL simulator in the **Timescales** pane, as described in the HDL Cosimulation block reference.

Define Simulink and HDL Simulator Timing Relationship

The differences in the representation of simulation time can be reconciled in one of two ways using the HDL Verifier interface:

- By defining the timing relationship manually (with **Timescales** pane)

When you define the relationship manually, you determine how many femtoseconds, picoseconds, nanoseconds, microseconds, milliseconds, seconds, or ticks in the HDL simulator represent 1 second in Simulink.

1 second in Simulink corresponds to in the HDL simulator

This quantity of HDL simulator time can be expressed in one of the following ways:

- In *relative* terms (i.e., as some number of HDL simulator ticks). In this case, the cosimulation is said to operate in *relative timing mode*. The HDL Cosimulation block defaults to relative timing mode for cosimulation. For more on relative timing mode, see “Relative Timing Mode” on page 8-60.
- In *absolute* units (such as milliseconds or nanoseconds). In this case, the cosimulation is said to operate in *absolute timing mode*. For more on absolute timing mode, see “Absolute Timing Mode” on page 8-65.

For more on relative and absolute time, see “Simulation Timescales” on page 8-57.

- By allowing HDL Verifier to define the timescale (with **Timescales** pane)

When you allow the link software to define the timing relationship, it attempts to set the timescale factor between the HDL simulator and Simulink to be as close as possible to 1 second in the HDL simulator = 1 second in Simulink. If this setting is not possible, the link product attempts to set the signal rate on the Simulink model port to the lowest possible number of HDL simulator ticks.

Before you begin, verify that the HDL simulator is running. HDL Verifier software can get the resolution limit of the HDL simulator only when that simulator is running.

You can choose to have HDL Verifier calculate a timescale while you are setting the parameters on the block dialog by clicking the **Timescale** option then clicking **Determine Timescale Now** or you can have HDL Verifier calculate the timescale when simulation begins by selecting **Automatically determine timescale at start of simulation**.

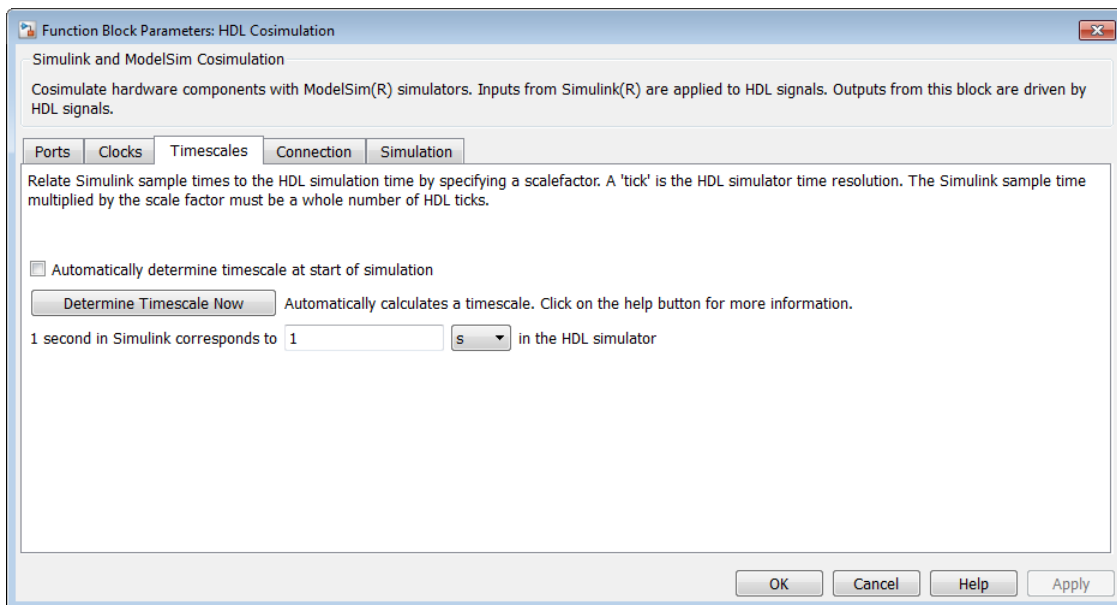

When you click **Determine Timescale Now**, HDL Verifier connects Simulink with the HDL simulator so that it can use the HDL simulator resolution to calculate the best timescale. You can accept the timescale HDL Verifier suggests or you can make changes in the port list directly. If you want to revert to the originally calculated settings, click **Use Suggested Timescale**. If you want to view sample times for all ports in the HDL design, select **Show all ports and clocks**.

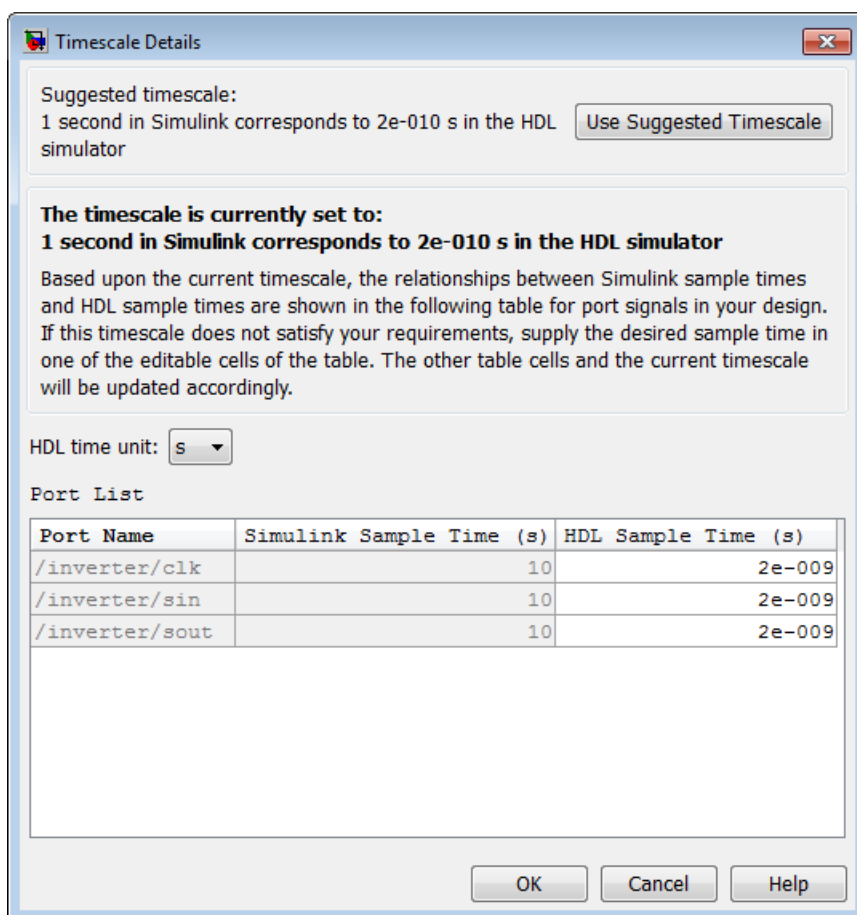

If you select **Automatically determine timescale at start of simulation**, you get the same dialog when the simulation starts in Simulink. Make the same adjustments

at that time, if applicable, that you would if you clicked **Determine Timescale Now** when you were configuring the block.

Configure Communication Link in the HDL Cosimulation Block

You must select shared memory or socket communication. See “HDL Cosimulation with MATLAB or Simulink”.

After you decide which type of communication, configure a block's communication link with the **Connection** pane of the block parameters dialog box (example shown for use with ModelSim).

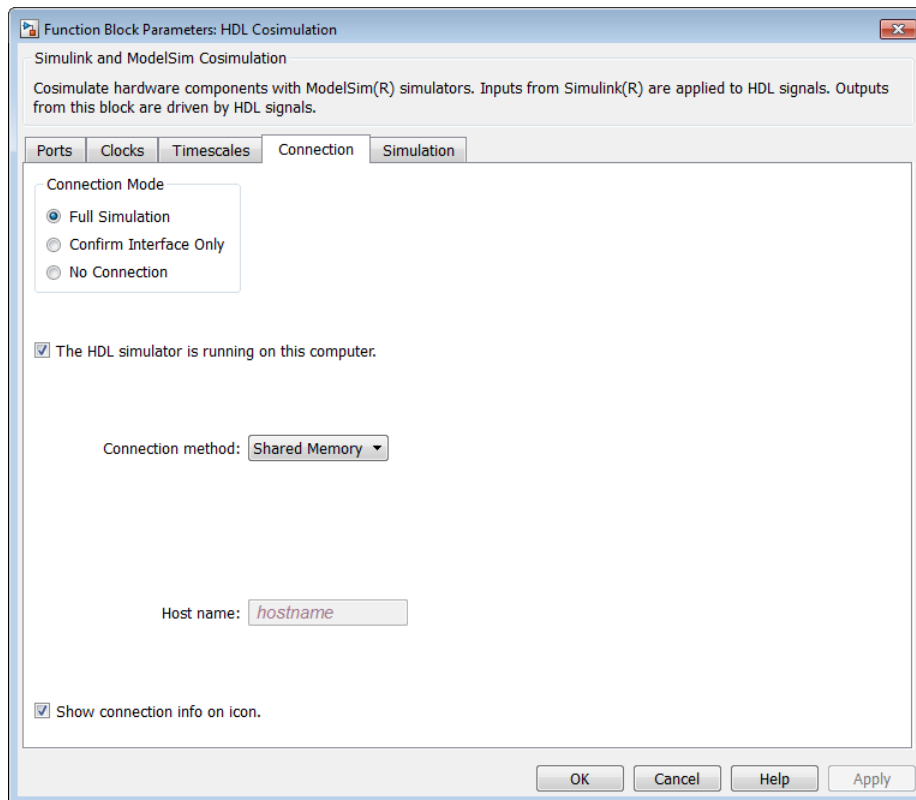

The following steps guide you through the communication configuration:

- 1 Determine whether Simulink and the HDL simulator are running on the same computer. If they are, skip to step 4.
- 2 Clear the **The HDL simulator is running on this computer** check box. (This check box defaults to selected.) Because Simulink and the HDL simulator are running on different computers, HDL Verifier sets the **Connection method** to **Socket**.
- 3 Enter the host name of the computer that is running your HDL simulation (in the HDL simulator) in the **Host name** text field. In the **Port number or service** text field, specify a valid port number or service for your computer system. For information on choosing TCP/IP socket ports, see “TCP/IP Socket Ports” on page 8-77. Skip to step 5.
- 4 If the HDL simulator and Simulink are running on the same computer, decide whether you are going to use shared memory or TCP/IP sockets for the communication channel. For information on the different modes of communication, see “HDL Cosimulation with MATLAB or Simulink”.

If you choose TCP/IP socket communication, specify a valid port number or service for your computer system in the **Port number or service** text field. For information on choosing TCP/IP socket ports, see “TCP/IP Socket Ports” on page 8-77.

If you choose shared memory communication, select the **Shared memory** check box.

- 5 If you want to bypass the HDL simulator when you run a Simulink simulation, use the **Connection Mode** options to specify what type of simulation connection you want. Select one of the following options:
 - **Full Simulation:** Confirm interface and run HDL simulation (default).
 - **Confirm Interface Only:** Check HDL simulator for expected signal names, dimensions, and data types, but do not run HDL simulation.
 - **No Connection:** Do not communicate with the HDL simulator. The HDL simulator does not need to be started.

With the second and third options, HDL Verifier software does not communicate with the HDL simulator during Simulink simulation.

- 6 Click **Apply**.

The following example dialog box shows communication definitions for an HDL Cosimulation block. The block is configured for Simulink and the HDL simulator

running on the same computer, communicating in TCP/IP socket mode over TCP/IP port 4449.

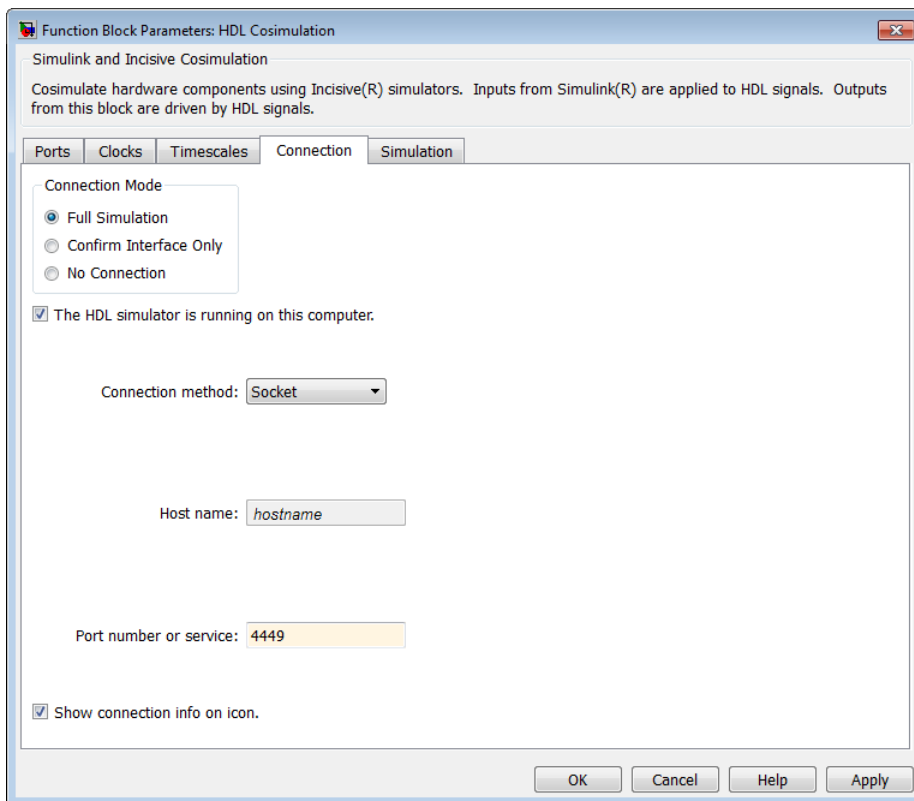

Specify Pre- and Post-Simulation Tcl Commands with HDL Cosimulation Block Parameters Dialog Box

You have the option of specifying Tcl commands to execute before and after the HDL simulator simulates the HDL component of your Simulink model. *Tcl* is a programmable scripting language supported by most HDL simulation environments. Use of Tcl can range from something as simple as a one-line `puts` command to confirm that a simulation is running or as complete as a complex script that performs an extensive simulation initialization and startup sequence. For example, you can use the **Post-simulation command** field on the Simulation Pane to instruct the HDL simulator to restart at the end of a simulation run.

Note for ModelSim Users After each simulation, it takes ModelSim time to update the coverage result. To prevent the potential conflict between this process and the next cosimulation session, add a short pause between each successive simulation.

You can specify the pre-simulation and post-simulation Tcl commands by entering Tcl commands in the **Pre-simulation** commands or **Post-simulation** commands text fields in the **Simulation** pane of the HDL Cosimulation block mask.

To specify Tcl commands, perform the following steps:

- 1 Select the **Simulation** tab of the Block Parameters dialog box. The dialog box appears as follows (example shown for use with ModelSim).

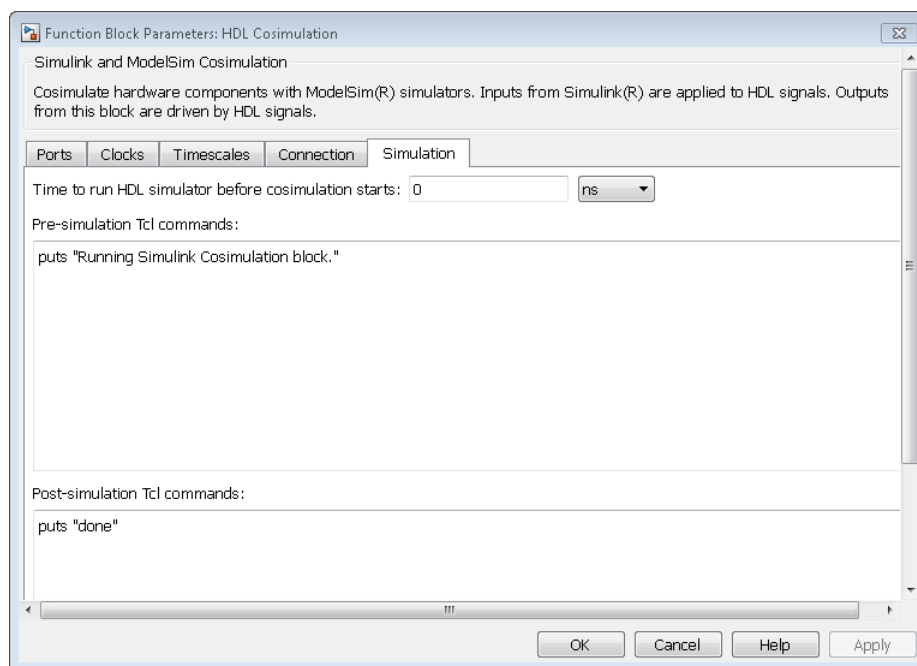

The **Pre-simulation commands** text box includes a `puts` command for reference purposes.

- 2 Enter one or more commands in the **Pre-simulation command** and **Post-simulation command** text boxes. You can specify one Tcl command per line in the

text box or enter multiple commands per line by appending each command with a semicolon (;), which is the standard Tcl concatenation operator.

ModelSim DO Files

Alternatively, you can create a ModelSim DO file that lists Tcl commands and then specify that file with the ModelSim `do` command as shown in the following figure.

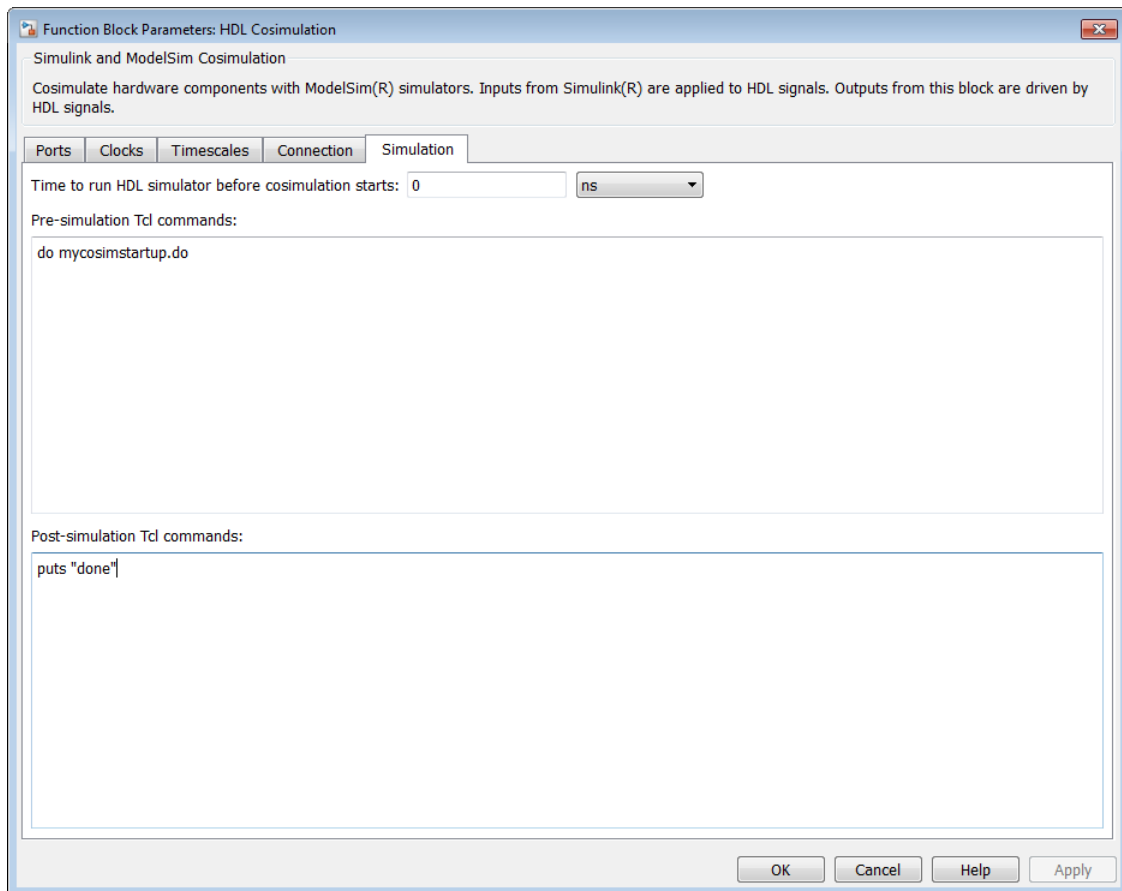

3 Click **Apply**.

Programmatically Control Block Parameters

One way to control block parameters is through the HDL `Cosimulation` block graphical dialog box. However, you can also control blocks by programmatically controlling the mask parameter values and the running of simulations. Parameter values can be read using the Simulink `get_param` function and written using the Simulink `set_param` function. All block parameters have attributes that indicate whether they are:

- **Tunable** — The attributes can change during the simulation run.
- **Evaluated** — The parameter string value undergoes an evaluation to determine its actual value used by the S-Function.

The HDL `Cosimulation` block does not have any tunable parameters; thus, you get an error if you try to change a value while the simulation is running. However, it does have a few evaluated parameters.

You can see the list of parameters and their attributes by performing a right-mouse click on the block, selecting **View Mask**, and then the **Parameters** tab. The **Variable** column shows the programmatic parameter names. Alternatively, you can get the names programmatically by selecting the HDL `Cosimulation` block and then typing the following commands at the MATLAB prompt:

```
>> get_param(gcf, 'DialogParameters')
```

Some examples of using MATLAB to control simulations and mask parameter values follow. Usually, the commands are put into a script or function file and are called by several callback hooks available to the model developer. You can place the code in any of these suggested locations, or anywhere you choose:

- In the model workspace, for example, **View > Model Explorer > Simulink Root > *model_name* > Model Workspace**, option **Data Source** is set to `Model File`.
- In a model callback, for example, **File > Model Properties > Callbacks**.
- A subsystem callback (right-mouse click on an empty subsystem and then select **Properties > Callbacks**). Many of the HDL Verifier demos use this technique to start the HDL simulator by placing MATLAB code in the `OpenFcn` callback.
- The HDL `Cosimulation` block callback (right-mouse click on HDL `Cosimulation` block, and then select **Properties > Callbacks**).

Example: Scripting the Value of the Socket Number for HDL Simulator Communication

In a regression environment, you may need to determine the socket number for the Simulink/HDL simulator connection during the simulation to avoid collisions with other simulation runs. This example shows code that could handle that task. The script is for a 32-bit Linux platform.

```
ttcp_exec = [matlabroot '/toolbox/shared/hdlink/scripts/ttcp_glnx'];
[status, results] = system([ttcp_exec ' -a']);
if ~s
    parsed_result = textscan(results, '%s');
    avail_port = parsed_result{1}{2};
else
    error(results);
end

set_param('MyModel/HDL Cosimulation', 'CommPortNumber', avail_port);
```

Run a Component Cosimulation Session

In this section...

“Simulink Software Configuration Parameters” on page 5-41

“Determine Available Socket Port Number” on page 5-42

“Check Connection Status” on page 5-42

“Run and Test Component Cosimulation Model” on page 5-42

“Avoid Race Conditions in HDL Simulation with Component Cosimulation and the HDL Verifier HDL Cosimulation Block” on page 5-45

Simulink Software Configuration Parameters

When you create a Simulink model that includes one or more HDL Verifier Cosimulation blocks, you might want to adjust certain Simulink parameter settings to best meet the needs of HDL modeling. For example, you might want to adjust the value of the **Stop time** parameter in the **Solver** pane of the Model Configuration Parameters dialog box.

You can adjust the parameters individually or you can use DSP System Toolbox Simulink model templates to automatically configure the Simulink environment with the recommended settings for digital signal processing modeling.

Parameter	Default Setting
'SingleTaskRateTransMsg'	'error'
'Solver'	'fixedstepdiscrete'
'SolverMode'	'singletasking'
'StartTime'	'0.0'
'StopTime'	'inf'
'FixedStep'	'auto'
'SaveTime'	'off'
'SaveOutput'	'off'
'AlgebraicLoopMsg'	'error'

The default settings for `SaveTime` and `SaveOutput` improve simulation performance.

For more information on DSP System Toolbox Simulink model templates, see the DSP System Toolbox documentation.

Determine Available Socket Port Number

To determine an available socket number use: `ttcp -a` a shell prompt.

Check Connection Status

You can check the connection status by clicking the Update diagram button or by selecting **Simulation > Update Diagram**. If you have an error in the connection, Simulink will notify you.

The MATLAB command `pingHdlSim` can also be used to check the connection status. If a -1 is returned, then there is no connection with the HDL simulator.

Run and Test Component Cosimulation Model

In general, the last stage of cosimulation is to run and test your model. There are some steps you must be aware of when changing your model during or between cosimulation sessions. although your testing methods may vary depending on which HDL simulator you have, You can review these steps in “Run and Test Test Bench Cosimulation Model” on page 4-43.

You can run the cosimulation in one of three ways:

- “Cosimulation Using the Simulink and HDL Simulator GUIs” on page 4-43
- “Cosimulation with Simulink Using the Command Line Interface (CLI)” on page 4-44
- “Cosimulation with Simulink Using Batch Mode” on page 4-45

Cosimulation Using the Simulink and HDL Simulator GUIs

Start the HDL simulator and load your HDL design. For test bench cosimulation, begin simulation first in the HDL simulator. Then, in Simulink, click **Simulation > Run** or the Run Simulation button. Simulink runs the model and displays any errors that it detects. You can alternate between the HDL simulator and Simulink GUIs to monitor the cosimulation results.

For component cosimulation, start the simulation in Simulink first, then begin simulation in the HDL simulator.

You can specify "GUI" as the property value for the run mode parameter of the HDL Verifier HDL simulator launch command, but since using the GUI is the default mode for HDL Verifier, you do not have to.

Cosimulation with Simulink Using the Command Line Interface (CLI)

Running your cosimulation session using the command-line interface allows you to interact with the HDL simulator during cosimulation, which can be helpful for debugging.

To use the CLI, specify "CLI" as the property value for the run mode parameter of the HDL Verifier HDL simulator launch command.

Caution Close the terminal window by entering `quit -f` at the command prompt. Do not close the terminal window by clicking the "X" in the upper right-hand corner. This causes a memory-type error to be issued from the system. This is not a bug with HDL Verifier but just the way the HDL simulator behaves in this context.

You can type CTRL+C to interrupt and terminate the simulation in the HDL simulator but this action also causes the memory-type error to be displayed.

Specify CLI mode with `nc1launch` (Cadence Incisive)

Issue the `nc1launch` command with "CLI" as the runmode property value, as follows (example entered into the MATLAB editor):

```
tclcmd = { ['cd ',unixprojdir],...
           ['exec ncvlog -linedebug ',unixsrcfile1],...
           'exec ncelab -access +wc work.inverter_v1',...
           'hdlsimulink -gui work.inverter_v1'
         };

nc1launch('tclstart',tclcmd,'runmode','CLI');
```

Specify CLI mode with `vsim` (Mentor Graphics ModelSim)

Issue the `vsim` command with "CLI" as the runmode property value, as follows (example entered into the MATLAB editor):

```
tclcmd = {'vlib work',...
          'vlog addone_vlog.v add_vlog.v top_frame.v',...
        };
```

```
'vsimulink top =socket 5002'};
vsim('tclstart',tclcmd,'runmode','CLI');
```

Cosimulation with Simulink Using Batch Mode

Running your cosimulation session in batch mode allows you to keep the process in the background, reducing demand on memory by disengaging the GUI.

To use the batch mode, specify "Batch" as the property value for the run mode parameter of the HDL Verifier HDL simulator launch command. After you issue the HDL Verifier HDL simulator launch command with batch mode specified, start the simulation in Simulink. To stop the HDL simulator before the simulation is completed, issue the `breakHdlSim` command.

Specify Batch mode with `nclaunch` (Cadence Incisive)

Issue the `nclaunch` command with 'Batch' as the runmode parameter, as follows:

```
nclaunch('tclstart',manchestercmds,'runmode','Batch')
```

You can also set runmode to 'Batch with Xterm', which starts the HDL simulator in the background but shows the session in an Xterm.

Specify Batch mode with `vsim` (Mentor Graphics ModelSim)

On Windows, specifying batch mode causes ModelSim to be run in a non-interactive command window. On Linux, specifying batch mode causes ModelSim to be run in the background with no window.

Issue the `vsim` command with 'Batch' as the runmode parameter, as follows:

```
>> vsim('tclstart',manchestercmds,'runmode','Batch')
```

Test Cosimulation

If you wish to reset a clock during a cosimulation, you can do so in one of these ways:

- By entering HDL simulator `force` commands at the HDL simulator command prompt
- By specifying HDL simulator `force` commands in the **Post- simulation command** text field on the **Simulation** pane of the HDL Verifier Cosimulation block parameters dialog box.

See also “Clock, Reset, and Enable Signals” on page 8-70.

If you change any part of the Simulink model, including the HDL Cosimulation block parameters, update the diagram to reflect those changes. You can do this update in one of the following ways:

- Rerun the simulation
- Click the Update diagram button
- Select **Simulation > Update Diagram**

Avoid Race Conditions in HDL Simulation with Component Cosimulation and the HDL Verifier HDL Cosimulation Block

In the HDL simulator, you cannot control the order in which clock signals (rising-edge or falling-edge) defined in the HDL Cosimulation block are applied, relative to the data inputs driven by these clocks. If you are careful to verify the relationship between the data and active edges of the clock, you can avoid race conditions that could create differing cosimulation results. See “Race Conditions in HDL Simulators” on page 8-46.

Record Simulink Signal State Transitions for Post-Processing

- “Add a Value Change Dump (VCD) File” on page 6-2
- “Visually Compare Simulink Signals with HDL Signals” on page 6-6

Add a Value Change Dump (VCD) File

In this section...
“Introduction to the To VCD File Block” on page 6-2
“Using the To VCD File Block” on page 6-3

Introduction to the To VCD File Block

A value change dump (VCD) file logs changes to variable values, such as the values of signals, in a file during a simulation session. VCD files can be useful during design verification. Some examples of how you might apply VCD files include the following cases:

- For comparing results of multiple simulation runs, using the same or different simulator environments
- As input to post-simulation analysis tools
- For porting areas of an existing design to a new design

VCD files can provide data that you might not otherwise acquire unless you understood the details of a device's internal logic. In addition, they include data that can be graphically displayed or analyzed with postprocessing tools, including, for example, the extraction of data about a particular section of a design hierarchy or data generated during a specific time interval.

Another example, this specifically for ModelSim users, is the ModelSim `vcd2wlf` tool, which converts a VCD file to a Wave Log Format (WLF) file that you can view in a ModelSim `wave` window.

The `To VCD File` block provided in the HDL Verifier block library serves as a VCD file generator during Simulink sessions. The block generates a VCD file that contains information about changes to signals connected to the block's input ports and names the file with a specified file name.

Note: The `To VCD File` block logs changes to states '1' and '0' only. The block does *not* log changes to states 'X' and 'Z'.

Using the To VCD File Block

To generate a VCD file, perform the following steps:

- 1 Open your Simulink model, if it is not already open.
- 2 Identify where you want to add the To VCD File block. For example, you might temporarily replace a scope with this block.
- 3 In the Simulink Library Browser, click HDL Verifier and then select the block library for your HDL simulator. You will see the HDL Cosimulation block icon and the To VCD File block icon.

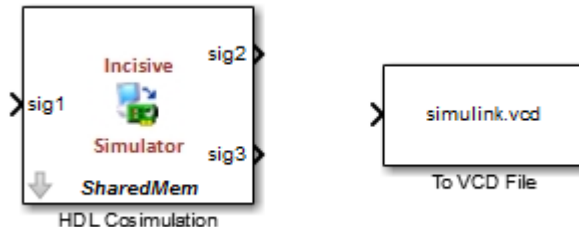

- 4 Copy the To VCD File block from the Library Browser to your model by clicking the block and dragging it from the browser to your model window.
- 5 Connect the block ports to the applicable blocks in your Simulink model.

Note: Because multidimensional signals are not part of the VCD specification, they are flattened to a 1-D vector in the file.

- 6 Configure the To VCD File block by specifying values for parameters in the Block Parameters dialog box, as follows:
 - a Double-click the block icon. Simulink displays the following dialog box.

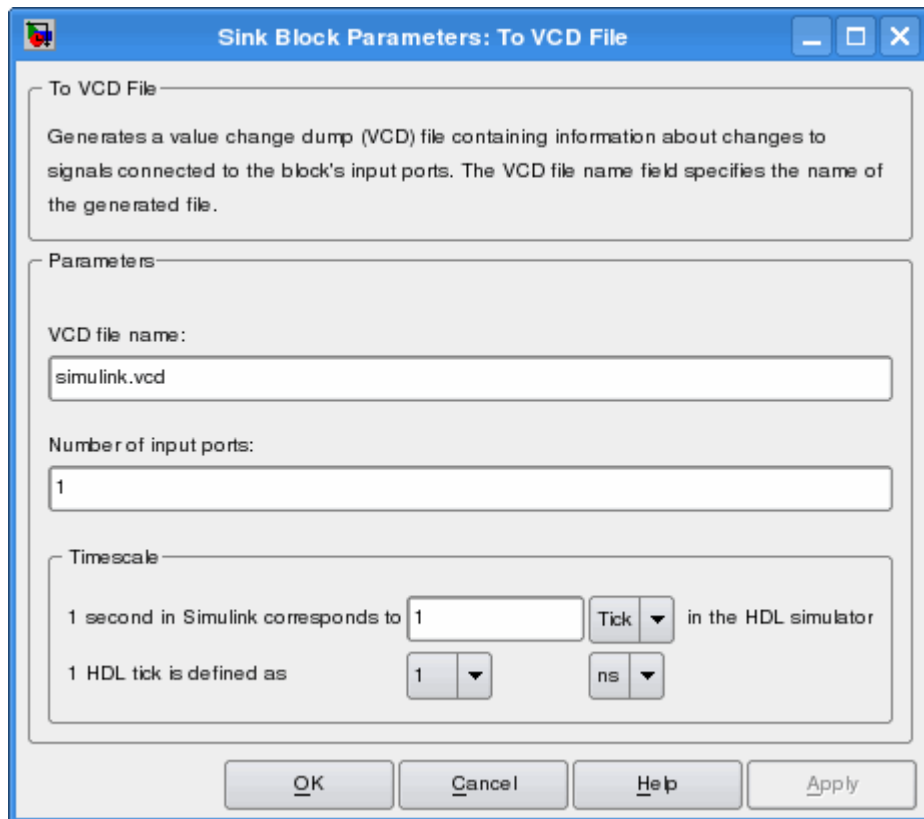

- b** Specify a file name for the generated VCD file in the **VCD file name** text box.
- If you specify a file name only, Simulink places the file in your current MATLAB folder.
 - Specify a complete path name to place the generated file in a different location.
 - If you want the generated file to have a `.vcd` file type extension, you must specify it explicitly.

Note: Do not give the same file name to different VCD blocks. Doing so results in invalid VCD files.

- c** Specify an integer in the **Number of input ports** text box that indicates the number of block input ports on which signal data is to be collected. The block can handle up to 94^3 (830,584) signals, each of which maps to a unique symbol in the VCD file.
 - d** Click **OK**.
- 7** Choose a timing relationship between Simulink and the HDL simulator. The time scale options specify a correspondence between one second of Simulink time and some quantity of HDL simulator time. Choose relative time or absolute time. For more on the To VCD File time scale, see the reference documentation for the **To VCD File** block.
 - 8** Run the simulation. Simulink captures the simulation data in the VCD file as the simulation runs.

For a description of the VCD file format see “VCD File Format”. For a sample application of a VCD file, see “Visually Compare Simulink Signals with HDL Signals” on page 6-6.

Visually Compare Simulink Signals with HDL Signals

In this section...
“Tutorial: Overview” on page 6-6
“Tutorial: Instructions” on page 6-6

Tutorial: Overview

Note: This tutorial and the tool used are specific to ModelSim users; however, much of the process will be the same for Incisive users with a similar tool. See HDL simulator documentation for details.

VCD files include data that can be graphically displayed or analyzed with postprocessing tools. An example of such a tool is the ModelSim `vcd2wlf` tool, which converts a VCD file to a WLF file that you can then view in a ModelSim **wave** window. This tutorial shows how you might apply the `vcd2wlf` tool.

Tutorial: Instructions

Perform the following steps to view VCD data:

- 1 Place a copy of the Manchester Receiver Simulink example `modelmanchestermodel` in a writable folder.
- 2 Open your writable copy of the Manchester Receiver model. For example, select **File > Open**, select the file `manchestermodel` and click **Open**. The Simulink model should appear as follows. The HDL Cosimulation block is marked “VHDL Manchester Receiver”.

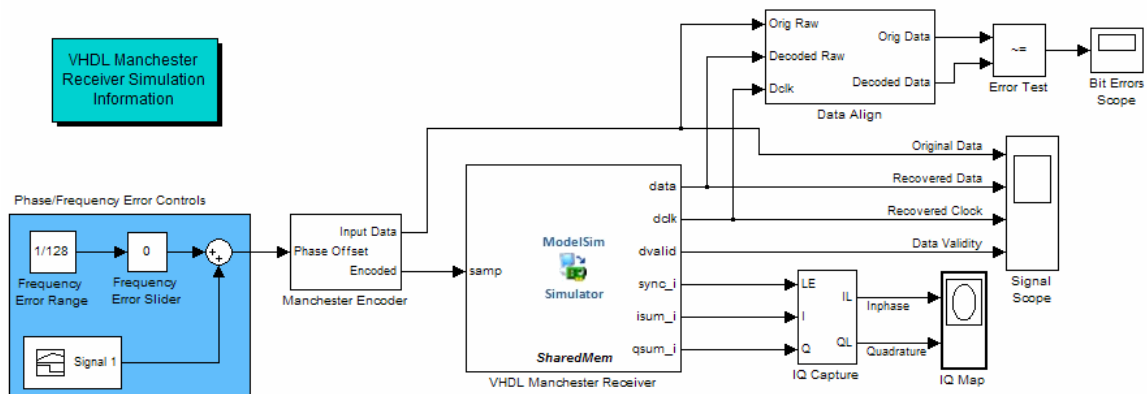

Before running this model you must first launch ModelSim.
 You can launch ModelSim on this computer using either a
 shared memory link or a TCP/IP socket link.

Shared memory link:

- 1) Be sure that the 'Connection' tab of the Cosimulation block dialog is set as follows:
 'ModelSim running on this computer' is checked
 and 'Shared memory' is selected
- 2) Execute the following MATLAB command:
`vsim('tclstart','manchestercmds')`
- 3) Start the Simulink simulation.

```

vsim('tclstart','manchestercmds')
%Double-click here to launch a new ModelSim
    
```

ModelSim Startup Command(Shared Memory)

TCP/IP socket link:

- 1) Be sure that the 'Connection' tab of the Cosimulation block dialog is set as follows:
 'ModelSim running on this computer' is checked
 and 'Socket' is selected
 'Port number or service' matches the port number used
 in the command below.
- 2) Execute the following MATLAB command:
`vsim('tclstart','manchestercmds','socketsimulink',4442)`
- 3) Start the Simulink simulation.

```

vsim('tclstart','manchestercmds','socketsimulink',4442)
%Double-click here to launch a new ModelSim
    
```

ModelSim Startup Command(TCP/IP Socket)

Copyright 2003-2009 The MathWorks, Inc.

Do not follow the numbered steps in the Manchester Receiver model. Follow only the steps provided in this tutorial.

- 3** Open the Library Browser.
- 4** Replace the Signal Scope block with a To VCD File block, as follows:
 - a** Delete the Signal Scope block. The lines representing the signal connections to that block change to dashed lines, indicating the disconnection.
 - b** Find and open the HDL Verifier block library.
 - c** Click "For Use with Mentor Graphics ModelSim" to access the HDL Verifier Simulink blocks for use with ModelSim.

- d Copy the **To VCD File** block from the Library Browser to the model by clicking the block and dragging it from the browser to the location in your model window previously occupied by the **Signal Scope** block.
- e Double-click the **To VCD File** block icon. The **Block Parameters** dialog box appears.
- f Type `MyVCDfile.vcd` in the **VCD file name** text box.
- g Type `4` in the **Number of input ports** text box.

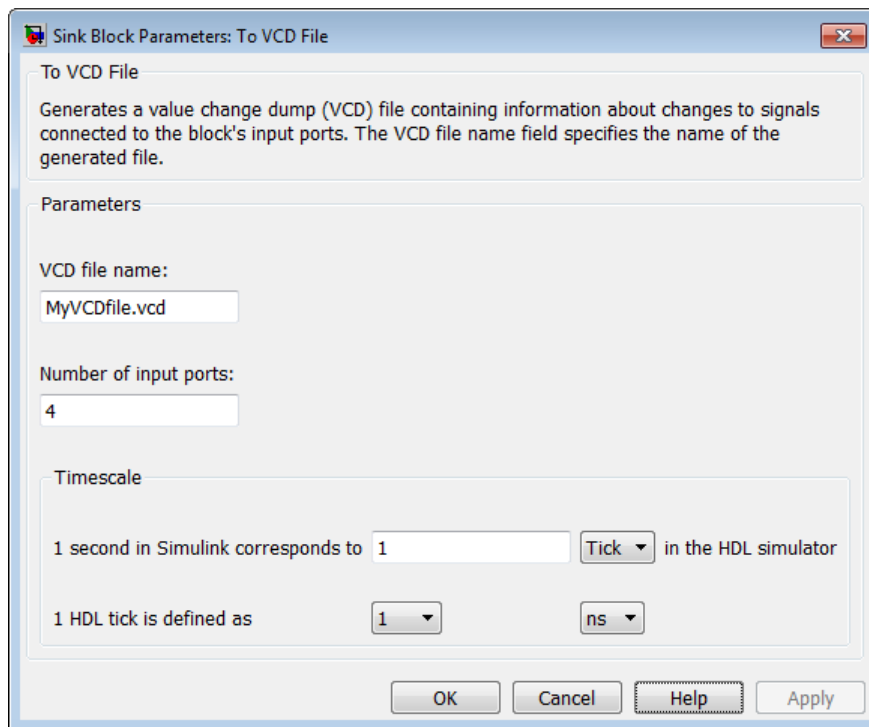

- h Click **OK**. Simulink applies the new parameters to the block.
- 5 Connect the signals **Original Data**, **Recovered Data**, **Recovered Clock**, and **Data Validity** to the block ports. The following display highlights the modified area of the model.

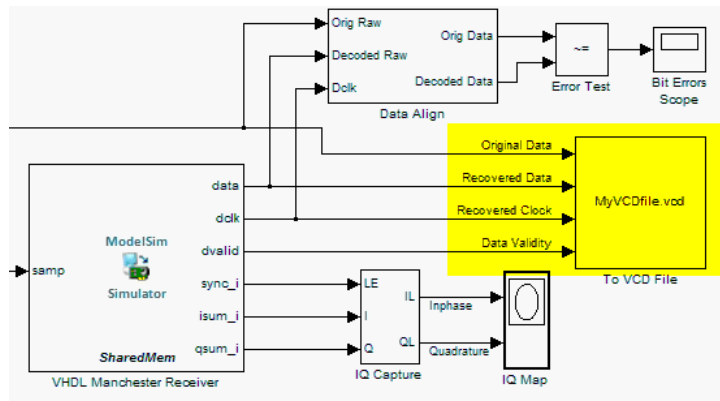

- 6 Save the model.
- 7 Select the following command line from the instructional text that appears in the demonstration model:

```
vsim('tclstart',manchestercmds,'socketsimulink',4442)
```
- 8 Paste the command in the MATLAB Command Window and execute the command line. This command starts ModelSim and configures it for a Simulink cosimulation session.
- 9 Open the HDL Cosimulation block parameters dialog box and select the **Connection** tab. Change the Connection method to Socket and “4442” for the TCP/IP socket port. The port you specify here must match the value specified in the call to the `vsim` command in the previous step.
- 10 Start the simulation from the Simulink model window.
- 11 When the simulation is complete, locate, open, and browse through the generated VCD file, `MyVCDfile.vcd` (any text editor will do).
- 12 Close the VCD file.
- 13 Change your input focus to ModelSim and end the simulation.
- 14 Change the current folder to the folder containing the VCD file and enter the following command at the ModelSim command prompt:

```
vcd2wlf MyVCDfile.vcd MyVCDfile.wlf
```

The `vcd2wlf` utility converts the VCD file to a WLF file that you display with the command `vsim -view`.

- 15 In ModelSim, open the wave file MyVCDfile.wlf as data set MyVCDwlf by entering the following command:

```
vsim -view MyVCDfile.wlf
```

- 16 Open the MyVCDwlf data set with the following command:

```
add wave MyVCDfile:/*
```

A **wave** window appears showing the signals logged in the VCD file.

- 17

Click the Zoom Full button  to view the signal data. The **wave** window should appear as follows.

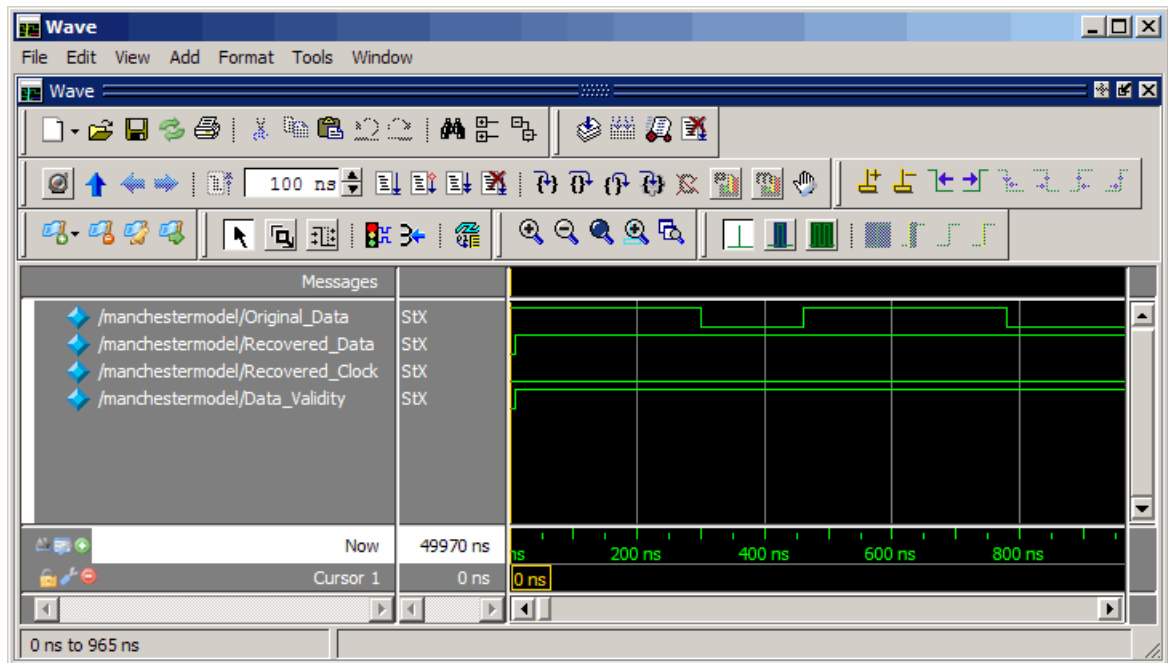

- 18 Exit the simulation. One way of exiting is to enter the following command:

```
dataset close MyVCDfile
```

ModelSim closes the data set, clears the **wave** window, and exits the simulation.

For more information on the `vcd2wlf` utility and working with data sets, see the ModelSim documentation.

HDL Code Import for Cosimulation

- “Import HDL Code for Cosimulation” on page 7-2
- “Invoke the Cosimulation Wizard” on page 7-5
- “Import HDL Code for MATLAB Function” on page 7-6
- “Import HDL Code for MATLAB System Object” on page 7-17
- “Import HDL Code for HDL Cosimulation Block” on page 7-33
- “Performing Cosimulation” on page 7-48
- “Cosimulation Wizard for MATLAB System Object” on page 7-50
- “Verify Raised Cosine Filter Design Using MATLAB” on page 7-69
- “Verify Raised Cosine Filter Design Using Simulink” on page 7-84
- “Help Button” on page 7-103

Import HDL Code for Cosimulation

In this section...
“HDL Code Import Features” on page 7-2
“HDL Code Import Workflows” on page 7-3
“Cosimulation Wizard Navigation” on page 7-3
“Cosimulation Wizard Limitations” on page 7-4

HDL Code Import Features

The HDL Verifier Cosimulation Wizard lets you take existing HDL code, from any source, and use it to create a MATLAB component or test bench function, System object, or Simulink HDL `Cosimulation` block. You can then use one of these *cosimulation interfaces* for cosimulation with a supported HDL simulator. See “Supported EDA Tools and Hardware”.

Each cosimulation type workflow requires that you complete the generated cosimulation interface when the wizard is completed. For example, if you specified a MATLAB function, the generated script contains some simple port I/O instructions and empty routines, which you will then need to complete for HDL cosimulation.

What You Need to Know

You are expected to understand the following about the HDL code you want to import:

- The name of the HDL files or compilation scripts to use in creating the block or function
- For Simulink blocks and MATLAB System objects:
 - The name of the top module to be used for cosimulation
 - Output port types and sample times
 - Whether there are clocks and resets and which of them you want to use, and timing parameters
 - Timescale
- For MATLAB functions:
 - Whether you want to create a component function or test bench function, or both

- How you want to trigger the callback (rising or falling edge, repeat, sensitivity)

For Simulink blocks, you must also have a destination model to receive the newly-generated block.

What the Cosimulation Wizard Needs to Know

The Cosimulation Wizard guides you through specifying the following types of information (some information depends on which type of cosimulation interface you want it to create):

- Type of cosimulation (MATLAB, MATLAB System object, or Simulink)
- Which HDL simulator to use
- HDL files to be included and compilation instructions
- HDL module information
- Callback details
- Input and output port details
- Clock and reset information and HDL simulator start time alignment

HDL Code Import Workflows

To learn more about how to use the Cosimulation Wizard, follow the workflow documentation specific to the cosimulation interface you want to create:

- “Import HDL Code for MATLAB Function” on page 7-6
- “Import HDL Code for MATLAB System Object” on page 7-17
- “Import HDL Code for HDL Cosimulation Block” on page 7-33

When you are ready to begin:

- 1 Close the ModelSim or Incisive simulator.
- 2 “Invoke the Cosimulation Wizard” on page 7-5.

Cosimulation Wizard Navigation

On each selection pane there is a status window and navigational options.

- The status window displays the current status of the options you have selected. Warnings are displayed here also.

- Click **Help** to display this HDL Code Import topic.
- Click **Cancel** to exit the Cosimulation Wizard without creating a cosimulation component.
- Click **Back** and **Next** to navigate forwards and backwards, respectively, through the application. Note that you can move forwards only after you have provided all information for the step you are on.

The last step of the Cosimulation Wizard generates the function scripts, System objects, or blocks and launches the specified HDL simulator.

- If you select a function or System object, the MATLAB Editor opens with the unfinished script or System object ready for editing.
- If you select a block, Simulink opens with the new block inside an untitled model.

Cosimulation Wizard Limitations

- When creating an HDL `Cosimulation` block or System object for use with Simulink, you may access only the I/O ports on the top level of the HDL design. If you want to cosimulate at multiple levels of your design, you cannot use this application to set up your HDL `Cosimulation` block or System object.
- You cannot create multiple HDL `Cosimulation` blocks, nor can you use multiple generated HDL `Cosimulation` blocks in the same model. This is primarily because you can only access the top level of the HDL design. There is no need for additional blocks.

Invoke the Cosimulation Wizard

- 1 Start MATLAB.
- 2 Enter the following command at the command prompt:

```
cosimWizard
```

The Cosimulation Wizard opens.

Select one of the following topics to continue instruction for the cosimulation interface you selected:

- “Import HDL Code for MATLAB Function” on page 7-6
- “Import HDL Code for MATLAB System Object” on page 7-17
- “Import HDL Code for HDL Cosimulation Block” on page 7-33

Import HDL Code for MATLAB Function

In this section...

“Cosimulation Type—MATLAB Function” on page 7-6

“HDL Files—MATLAB Function” on page 7-8

“HDL Compilation—MATLAB Function” on page 7-9

“HDL Modules—MATLAB Function” on page 7-10

“Callback Schedule—MATLAB Function” on page 7-12

“Script Generation—MATLAB Function” on page 7-14

“Complete the Component or Test Bench Function” on page 7-15

Cosimulation Type—MATLAB Function

If you have not yet done so, invoke the Cosimulation Wizard. See “Invoke the Cosimulation Wizard” on page 7-5.

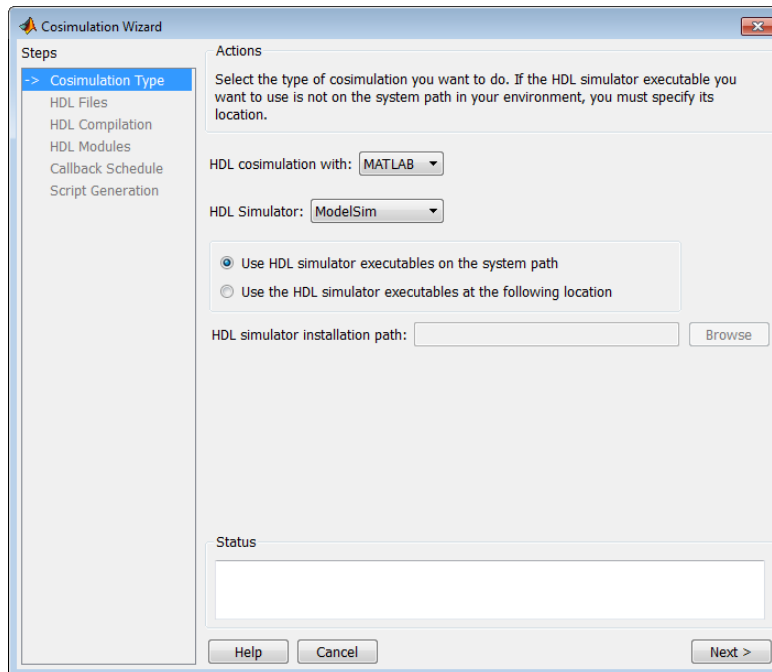

- 1 In the **Cosimulation Type** pane, select MATLAB in the field **HDL cosimulation with** to create a MATLAB function template (test bench or component).
- 2 Select ModelSim or Incisive for the **HDL Simulator**.
- 3 Select **Use HDL simulator executables on the system path** if that is where the files are located. The Cosimulation Wizard assumes by default that they are on the system path.

If the HDL simulator executables are *not* on the system path, select **Use the following HDL simulator executables at the following location** and specify the folder location in the text box below.

If you click **Next** and the Cosimulation Wizard does not find the executables, the following occurs:

- You are returned to this dialog and the Cosimulation Wizard displays an error in the status pane.
- The Cosimulation Wizard switches the option to **Use the following HDL simulator executables at the following location**.
- The Cosimulation Wizard makes the HDL simulation path field editable.

You must enter a valid path to the HDL simulator executables before you are allowed to continue.

- 4 Click **Next**.

HDL Files — MATLAB Function

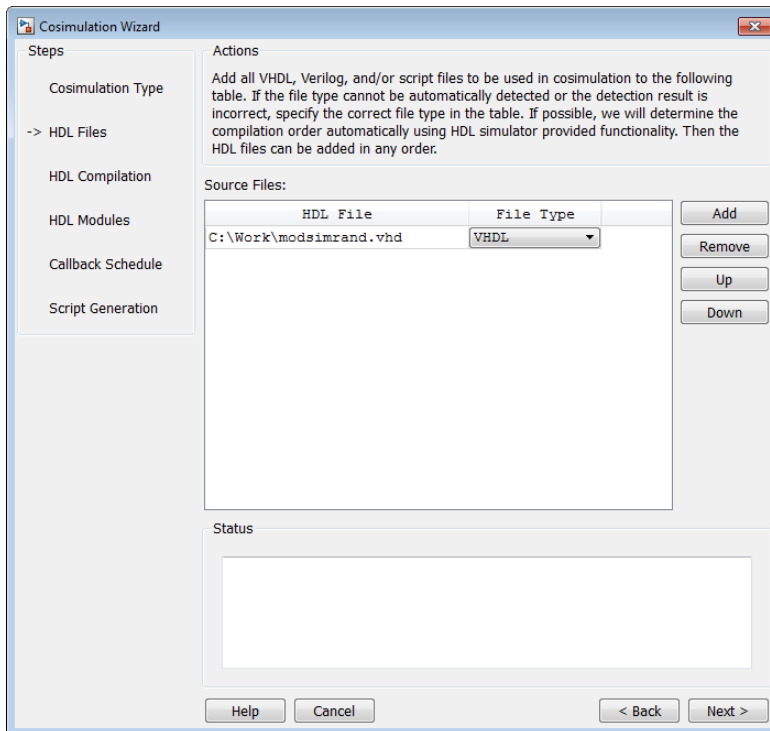

In the **HDL Files** pane, specify the files to be used in creating the function or block.

- The Cosimulation Wizard attempts to determine the file type of each file and display the type in the **File List** next to the file name. If the Cosimulation Wizard cannot determine the type or displays the wrong type, you can change the type directly in the **File Type** column.
- If possible, the Cosimulation Wizard will determine the compilation order automatically using HDL simulator provided functionality. This means you can add the files in any order.
- If you are using ModelSim, you will see compilation scripts listed as .do files (ModelSim macro file). If you are using Incisive, you will see compilation scripts listed as system scripts.

- 1 Click **Add** to select one or more file names.

- 2 Remove files by first highlighting the file name in the **File List**, then clicking **Remove Selected File**.
- 3 Click **Next**.

HDL Compilation—MATLAB Function

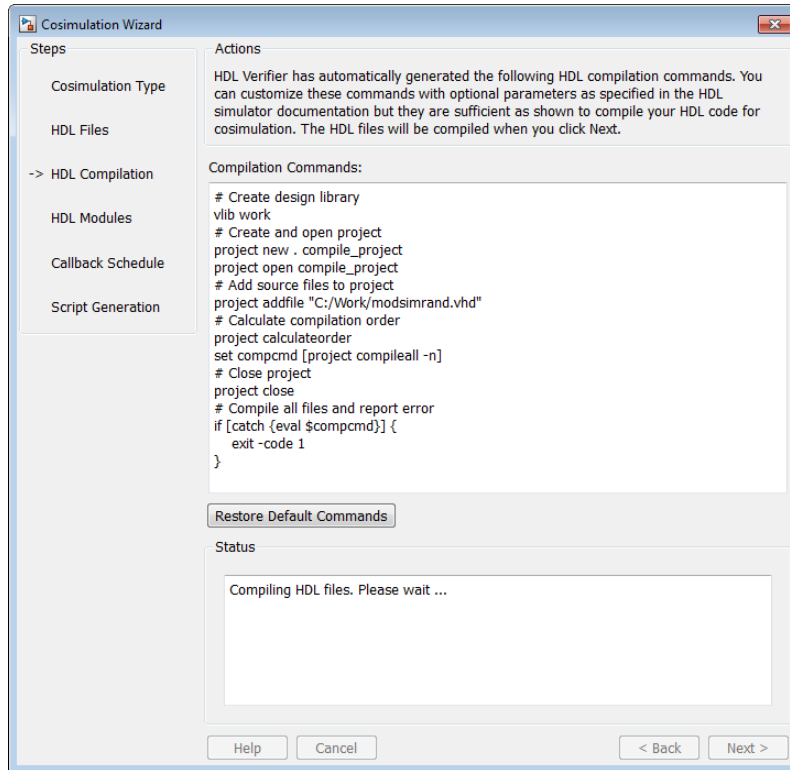

In the **HDL Compilation** pane, you can review the generated HDL compilation commands. You may override and/or customize those commands, if you wish. If you included compilation scripts instead of HDL files, this pane will show you the command to run those scripts.

- 1 Enter any changes to the commands in the **Compilation Commands** box.

Note: Do not include system shell commands; for example:

```
set file = a.vhd vcom $file
```

When control returns to the Cosimulation Wizard from executing the command, the variable no longer holds the value that was set. If you do try to include this type of command, you will see an error in the **Status** panel.

- 2 Click **Restore default commands** to go back to the generated HDL compilation commands. You are asked to confirm that you want to discard any changes.
- 3 Click **Next** to proceed.

HDL Modules — MATLAB Function

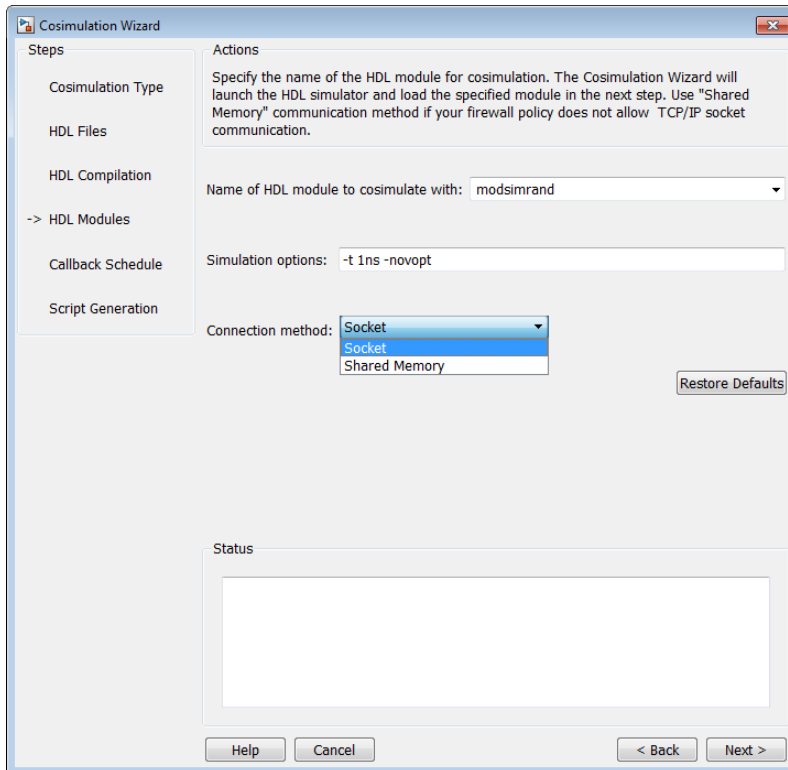

In the **HDL Module** pane, provide the name of the HDL module to be used in cosimulation.

- 1 Enter the name of the module at **Name of HDL module to cosimulate with**.
- 2 Specify additional simulation options at **Simulation options**. For example, in the previous image, the options shown are:
 - HDL simulator resolution
 - Turn off optimizations that remove signals from the simulation view

Click **Restore Defaults** to change the options back to the default.

- 3 For **Connection method**, select **Shared Memory** if your firewall policy does not allow TCP/IP socket communication.
- 4 Click **Next** to proceed to the next step. At this time in the process, the application performs the following actions in a command window:
 - Starts the HDL simulator.
 - Loads the HDL module in the HDL simulator.
 - Starts the HDL server, and waits to receive notice that the server has started.
 - Connects with the HDL server to get the port information.
 - Disconnects and shuts down the HDL server.

Callback Schedule—MATLAB Function

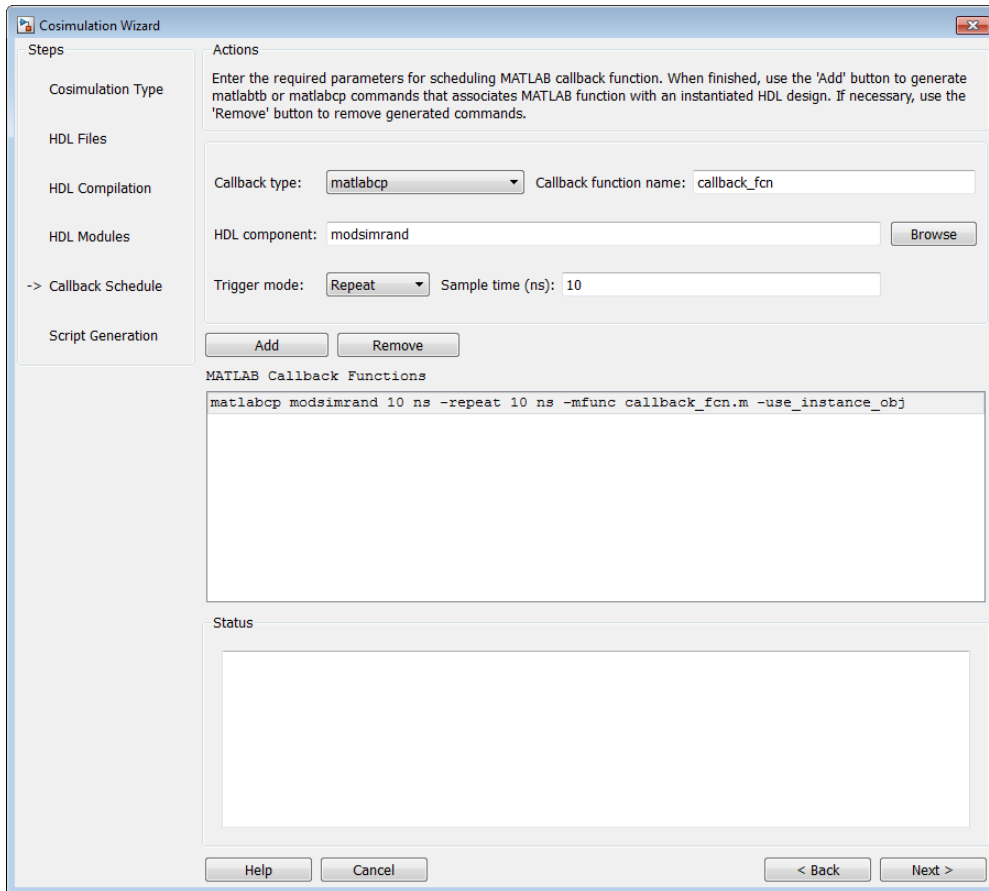

- 1 In the **Callback Schedule** pane, enter multiple component or test bench function callbacks from the HDL simulator. Enter the following information for each callback function:
 - **Callback type:** select `matlabcp` to create a component function or `matlabtb` to create a test bench function.
 - **Callback function name** (optional): Specify the name of component or test bench function, if it is not the same as the HDL component. The default assumption is that the function name is the same as the HDL component name.

- **HDL component:** Enter component name manually or browse for it by clicking **Browse**.
- **Trigger mode:** Specify one of the following to trigger the callback function:
 - Repeat
 - Rising Edge
 - Falling Edge
 - Sensitivity
- **Sample time (ns) or Trigger Signal:**
 - If you selected trigger **Repeat**, enter the sample time in nanoseconds.
 - If you selected **Rising Edge**, **Falling Edge**, or **Sensitivity**, **Sample time (ns)** changes to **Trigger Signal**. Enter the signal name to be used to trigger the callback.

You can browse the existing signals in the HDL component you specified by clicking **Browse**.

- 2 Click **Add** to add the command to the MATLAB Callback Functions list.

If you have more callback functions you want to schedule, repeat the above steps. If you want to remove any callback functions, highlight the line you want to remove and click **Remove**.

Note: If you attempt to add a callback function for the same HDL module as an existing callback function in the MATLAB Callback Functions list, the new callback function will overwrite the existing one (this is true even if you change the callback type). You will see a warning in the **Status** window:

Warning: This HDL component already has a scheduled callback function, which is replaced by this new one.

- 3 Click **Next**.

Script Generation—MATLAB Function

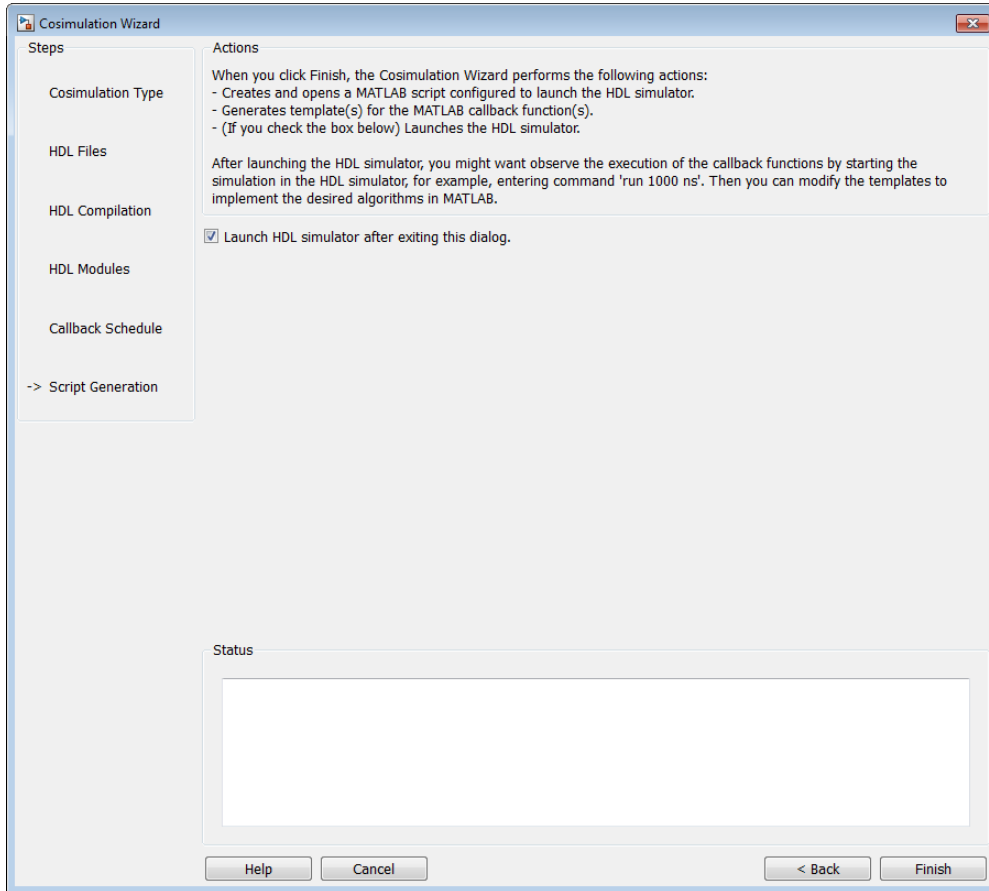

- 1 Click **Back** to review or change your settings.
- 2 Click **Finish** to generate scripts.

Generated Files—MATLAB Function

The Cosimulation Wizard creates the following files and opens each one in a separate MATLAB Editor windows.

- `launchHDLsimulator`: script for launching the HDL simulator for cosimulation with MATLAB.

- `compileHDLDesign`: compilation script you can reuse for subsequent compilation of this particular component.
- Function files (`*.m`): component and test bench customized function templates, one for each component specified in the Cosimulation Wizard.

Complete the Component or Test Bench Function

The template that the wizard generates contains some simple port I/O instructions and empty routines where you add your own code, as shown in the example below. For a full example of creating and using a MATLAB function, see “Verify Raised Cosine Filter Design Using MATLAB” on page 7-69.

```
function osc_top_u_osc_filter1x(obj)
% Automatically generated MATLAB(R) callback function.

% Copyright 2010 The MathWorks, Inc.
% $Revision $

% Initialize state of callback function.
if (strcmp(obj.simstatus, 'Init'))
    disp('Initializing states ...');

    % Store port information in userdata
    % The name strings of ports that sends data from HDL simulator to
    % MATLAB callback function
    obj.userdata.FromHdlPortNames = fields(obj.portinfo.out);
    obj.userdata.FromHdlPortNum   = length(fields(obj.portinfo.out));

    % The name strings of ports that sends data from MATLAB callback
    % function to HDL simulator
    obj.userdata.ToHdlPortNames   = fields(obj.portinfo.in);
    obj.userdata.ToHdlPortNum     = length(fields(obj.portinfo.in));

    % Initialize state
    obj.userdata.State = 0;
end

% Obj.tnow is the current HDL simulation time specified in seconds
disp(['Callback function is executed at time ' num2str(obj.tnow)]);

if(obj.userdata.FromHdlPortNum > 0)
    % The name of the first input port
    portName = obj.userdata.FromHdlPortNames{1};
    disp(['Reading input port ' portName]);
    % Convert the multi-valued logic value of the first port to decimal
    portValueDec = mvl2dec( ...
        obj.portvalues.(portName), ... % Multi-valued logic of the first port
        obj.portinfo.out.(portName).size); %#ok<NASGU> % Bit width
    % Then perform any necessary operations on this value passed by HDL simulator.
    % ...
    % Optionally, you can translate the port value into fixed point object,
    % e.g.
    % myfiobj = fi(portValueDec,1, 16, 4);
end

% Update your state(s). In the following example, we use this internal
```

```
% state to implement a one-bit counter
obj.userdata.State = -obj.userdata.State;

if(obj.userdata.ToHdlPortNum > 0)
    % The name of the first output port in HDL
    portName = obj.userdata.ToHdlPortNames{1};
    disp(['Writing output port ' portName]);

    % Assign the first port value to internal state obj.userdata.State.
    % Before assignment, convert decimal value to multi-valued logic.
    % You can change obj.userdata.State to another other valid decimal values.
    obj.portvalues.(portName) = dec2mvl(...
        obj.userdata.State, ...
        obj.portinfo.in.(portName).size);

    % Operate on other out ports, if there are any.
    % ...
end
```

Import HDL Code for MATLAB System Object

In this section...

“Cosimulation Type—MATLAB System Object” on page 7-17

“HDL Files—MATLAB System Object” on page 7-20

“HDL Compilation—MATLAB System Object” on page 7-21

“Simulation Options—MATLAB System Object” on page 7-23

“Input/Output Ports—MATLAB System Objects” on page 7-24

“Output Port Details—MATLAB System Object” on page 7-25

“Clock/Reset Details—MATLAB System Object” on page 7-26

“Start Time Alignment—MATLAB System Object” on page 7-28

“System Object Generation” on page 7-29

“Write System Object Test Bench” on page 7-30

“Run Cosimulation and Verify HDL Design” on page 7-32

Cosimulation Type—MATLAB System Object

If you have not yet done so, invoke the Cosimulation Wizard. See “Invoke the Cosimulation Wizard” on page 7-5.

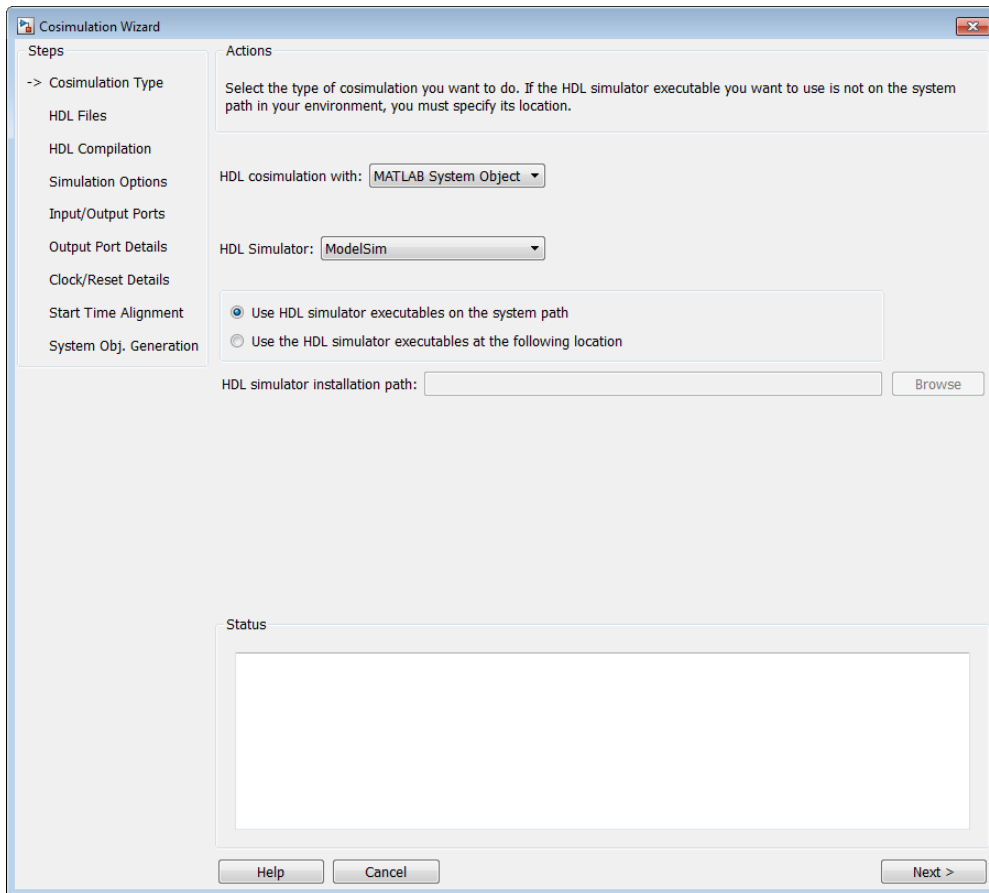

- 1 In the **Cosimulation Type** pane, select **MATLAB System object** in the field **HDL cosimulation with**.
- 2 Select **ModelSim** or **Incisive** for the **HDL Simulator**.
- 3 Select **Use HDL simulator executables on the system path** if that is where the files are located. The Cosimulation Wizard assumes by default that they are on the system path.

If the HDL simulator executables are *not* on the system path, select **Use the following HDL simulator executables at the following location** and specify the folder location in the text box below.

If you click **Next** and the Cosimulation Wizard does not find the executables, the following occurs:

- You are returned to this dialog and the Cosimulation Wizard displays an error in the status pane.
- The Cosimulation Wizard switches the option to **Use the following HDL simulator executables at the following location**.
- The Cosimulation Wizard makes the HDL simulation path field editable.

You must enter a valid path to the HDL simulator executables before you are allowed to continue.

4 Click **Next**.

HDL Files — MATLAB System Object

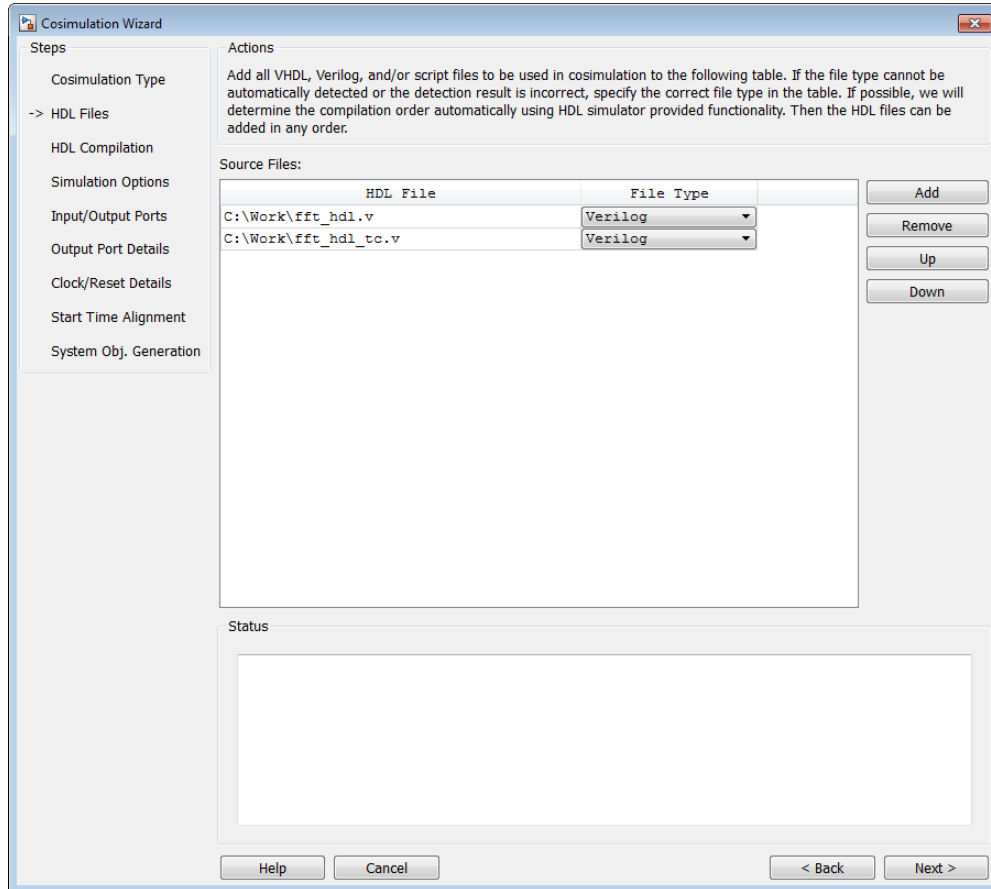

In the **HDL Files** pane, specify the files to be used in creating the function or block.

- The Cosimulation Wizard attempts to determine the file type of each file and display the type in the **File List** next to the file name. If the Cosimulation Wizard cannot determine the type or displays the wrong type, you can change the type directly in the **File Type** column.
- If possible, the Cosimulation Wizard will determine the compilation order automatically using HDL simulator provided functionality. This means you can add the files in any order.

- If you are using ModelSim, you will see compilation scripts listed as .do files (ModelSim macro file). If you are using Incisive, you will see compilation scripts listed as system scripts.
- 1 Click **Add** to select one or more file names.
 - 2 Remove files by first highlighting the file name in the **File List**, then clicking **Remove Selected File**.
 - 3 Click **Next**.

HDL Compilation—MATLAB System Object

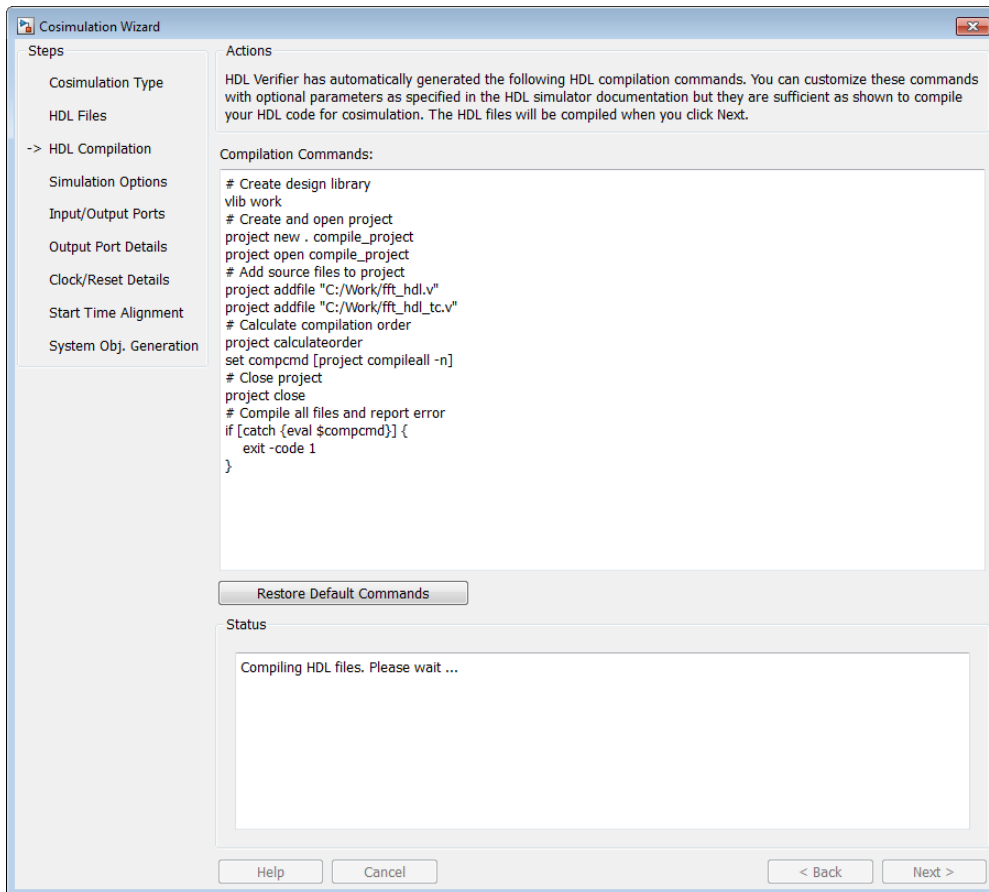

In the **HDL Compilation** pane, you can review the generated HDL compilation commands. You may override and/or customize those commands, if you wish. If you included compilation scripts instead of HDL files, this pane will show you the command to run those scripts.

- 1 Enter any changes to the commands in the **Compilation Commands** box.

Note: Do not include system shell commands; for example:

```
set file = a.vhd vcom $file
```

When control returns to the Cosimulation Wizard from executing the command, the variable no longer holds the value that was set. If you do try to include this type of command, you will see an error in the **Status** panel.

- 2 Click **Restore default commands** to go back to the generated HDL compilation commands. You are asked to confirm that you want to discard any changes.
- 3 Click **Next** to proceed.

Simulation Options—MATLAB System Object

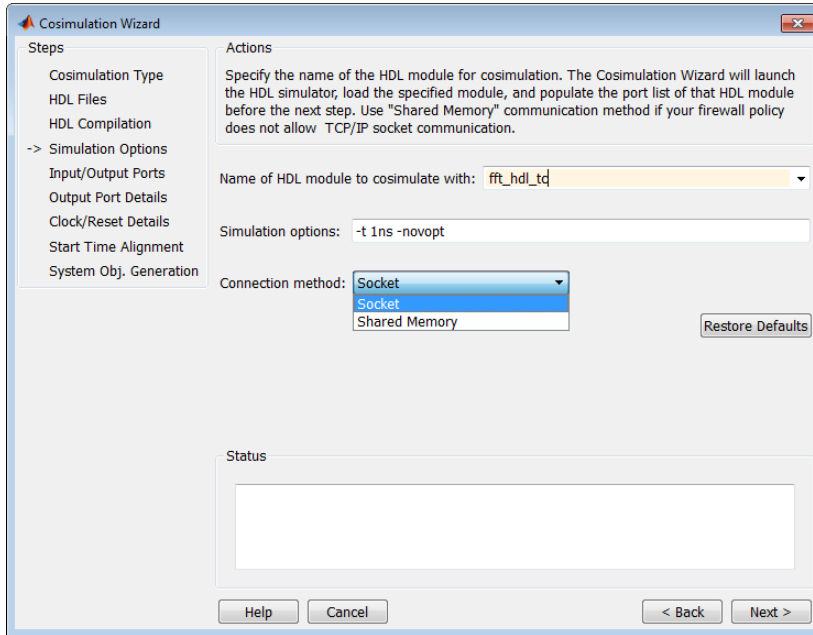

In the **HDL Module** pane, provide the name of the HDL module to be used in cosimulation.

- 1 Enter the name of the module at **Name of HDL module to cosimulate with**.
- 2 Specify additional simulation options at **Simulation options**. For example, in the previous image, the options shown are:

- HDL simulator resolution
- Turn off optimizations that remove signals from the simulation view

Click **Restore Defaults** to change the options back to the default.

- 3 For **Connection method**, select **Shared Memory** if your firewall policy does not allow TCP/IP socket communication.
- 4 Click **Next** to proceed to the next step. At this time in the process, the application performs the following actions in a command window:
 - Starts the HDL simulator.

- Loads the HDL module in the HDL simulator.
- Starts the HDL server, and waits to receive notice that the server has started.
- Connects with the HDL server to get the port information.
- Disconnects and shuts down the HDL server.

Input/Output Ports—MATLAB System Objects

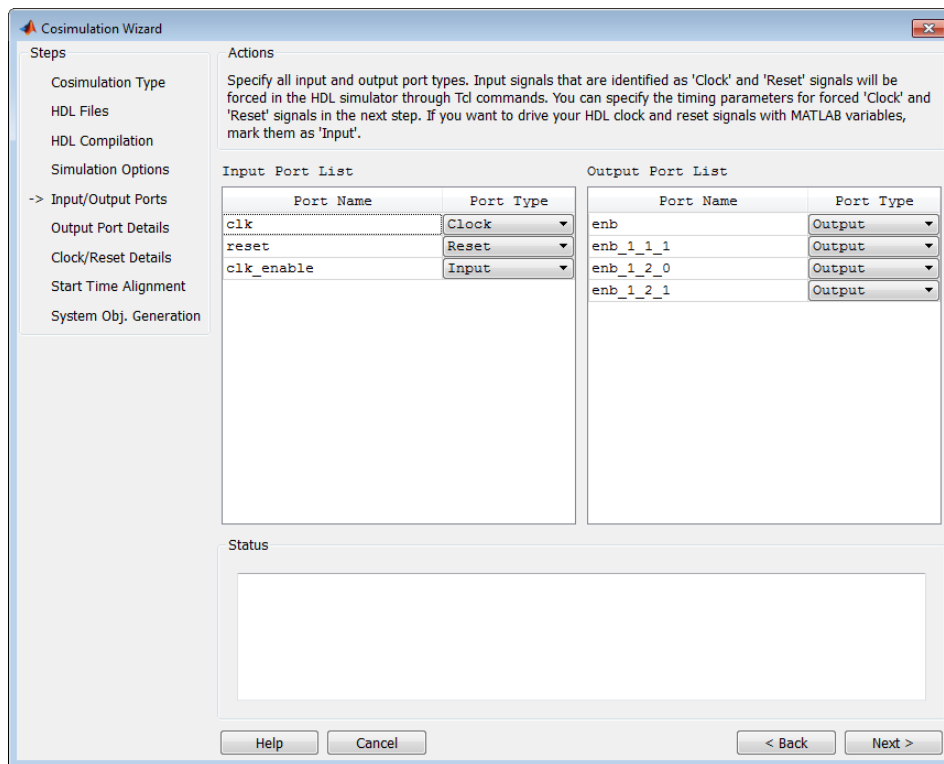

- 1 In the **Input/Output Ports** pane, specify the type of each input and output port (Input, Clock, Reset, or Unused).
 - The Cosimulation Wizard attempts to determine the port types for you, but you may override any setting.

- MATLAB forces clock and reset signals in the HDL simulator through Tcl commands. You can specify clock and reset signal timing in a later step (see “Clock/Reset Details—MATLAB System Object” on page 7-26).

2 Click **Next**.

Output Port Details—MATLAB System Object

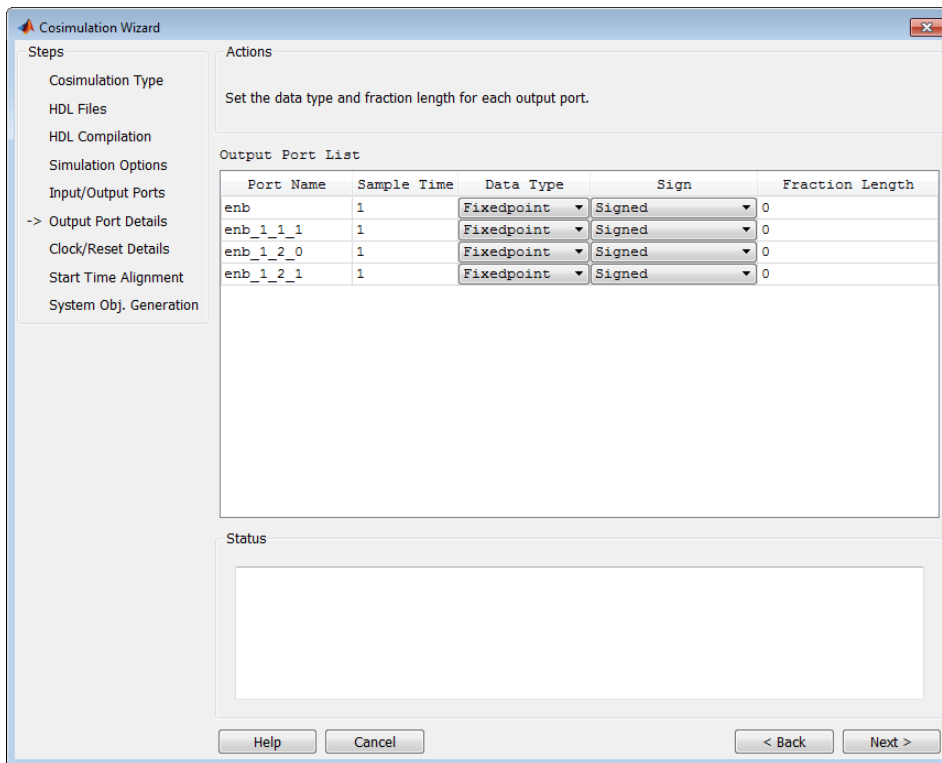

- 1 In the **Output Port Details** pane, set the sample time and data type for all output ports.
 - Sample time default is 1, the data type default is **Inherit** and **Signed**. These defaults are consistent with the way the HDL **Cosimulation** block mask (**Ports** tab) sets default settings for output ports (Simulink workflow).
 - If you select **Set all sample times and data types to 'Inherit'**, the ports inherit the times via back propagation (sample times are set to -1). However, back

propagation may fail in some circumstances; see “Backpropagation in Sample Times”.

- 2 Click **Next**.

Clock/Reset Details—MATLAB System Object

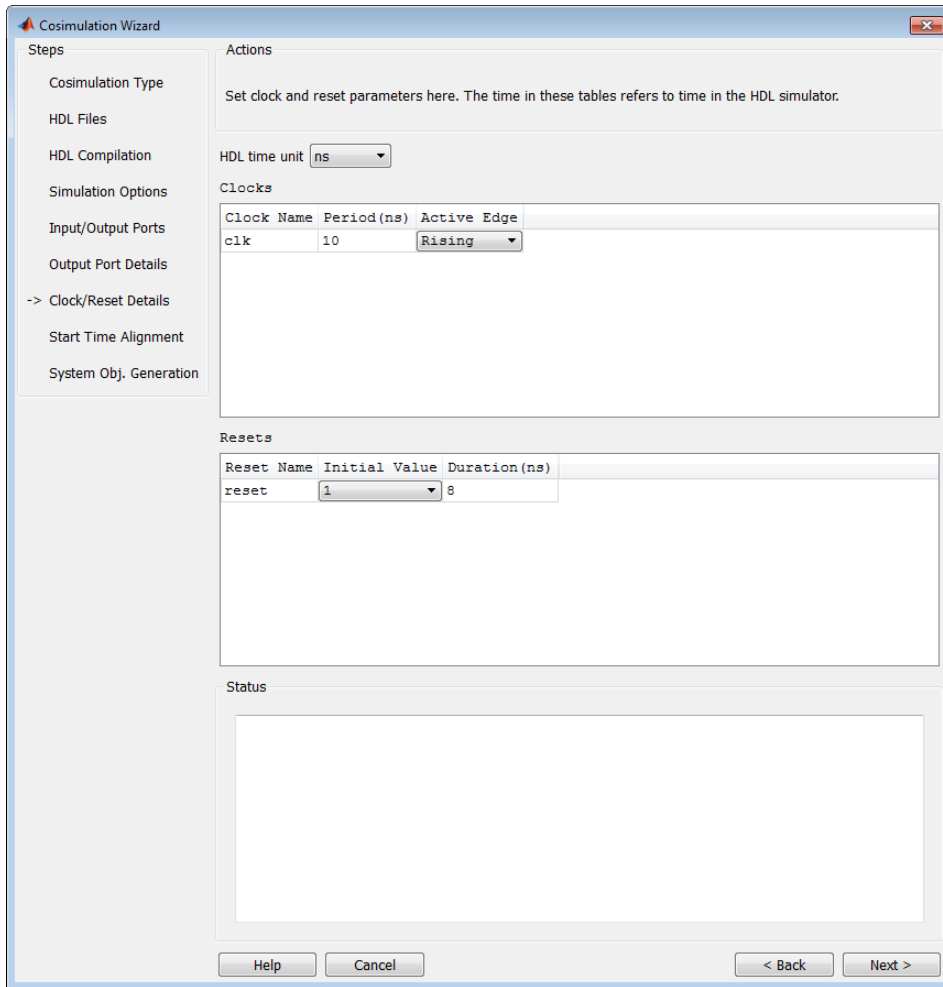

- 1 In the **Clock/Reset Details** pane, set the clock and reset parameters.

- The time period specified here refers to time in the HDL simulator.
- The clock default settings are a rising active edge and a period of 10 ns.
- The reset default settings are an initial value of 0 and a duration of 15 ns.

The next screen provides a visual display of the simulation start time where you can review how the clocks and resets line up.

2 Click **Next**.

Start Time Alignment—MATLAB System Object

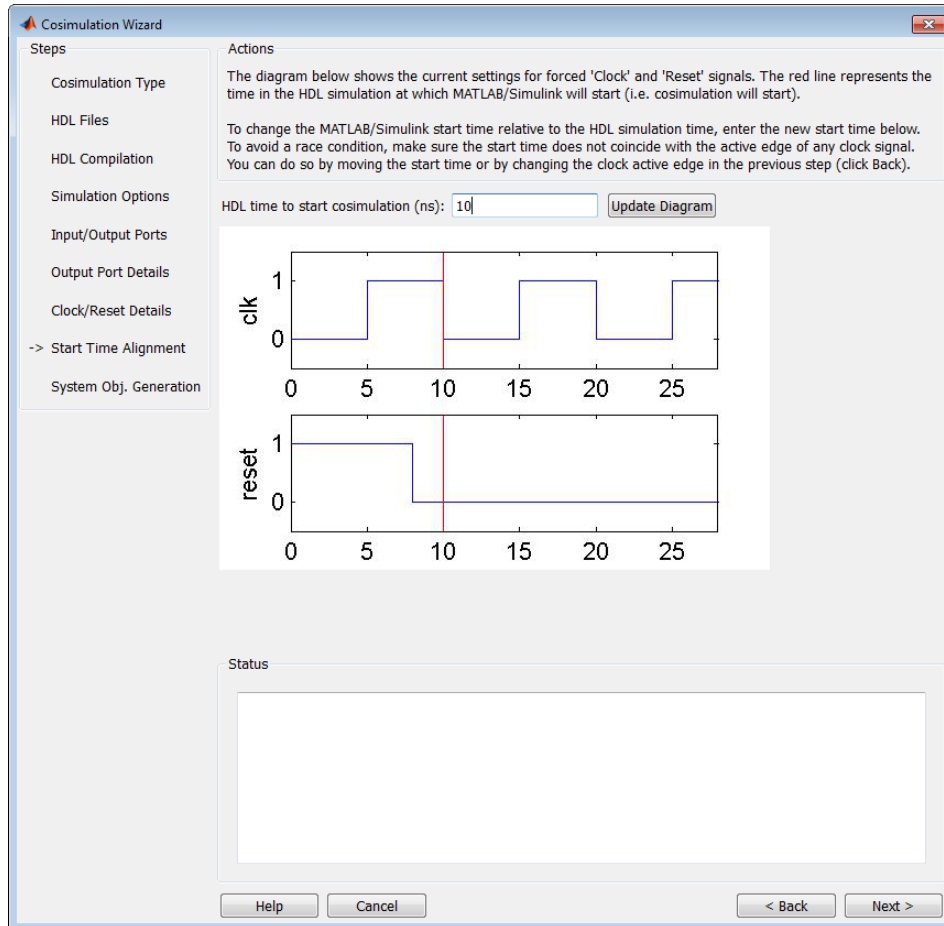

- 1 In the **Start Time Alignment** pane, review the current settings for clocks and resets. The purpose for this dialog is twofold:
 - To make sure the rising or falling edge is set as expected (from the previous step)
 - Examine the start time. If it coincides with the active edge of the clock, you need to adjust the HDL simulator start time.

- Examine the reset signal. If it is synchronous with the clock active edge, you may have a possible race condition.

To avoid a race condition, make sure the start time does not coincide with the active edge of any clocks. You can do this by moving the start time or by changing clock active edges in the previous step.

- To make sure the start time is where you want it.

The HDL simulator start time is calculated from the clock and reset values on the previous pane. If you want, you can change the HDL simulator start time by entering a new value where you see **HDL time to start cosimulation (ns)**. Click **Update plot** to see your change applied.

- 2 Click **Next**.

System Object Generation

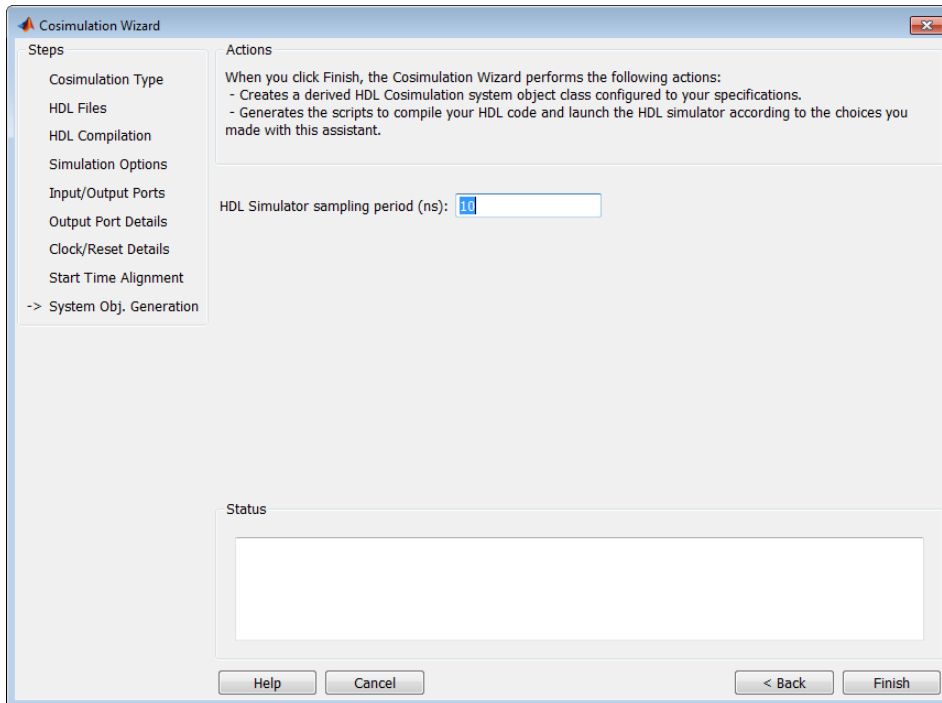

- 1 You can modify the HDL simulator sampling period before the wizard generates the System object. Enter the new value in the box labeled **HDL Simulator sampling period (ns)**.

The sampling period determines the elapsed time in the HDL Simulator separating each call to step in MATLAB. Most of the time the sampling period is equal to the clock period.

- 2 If your inputs and outputs are frame based (instead of sample based), select **Frame based processing**.
- 3 Click **Finish**.

After you click **Finish**, the wizard generates the following HDL files in the current directory:

- `compile_hdl_design_design_name.m`: Script for recompiling the HDL design
- `launch_hdl_simulator_design_name.m`: Script for relaunching the MATLAB System object server and starting the HDL simulator
- `hdlcosim_design_name.m`: Script for creating the HDLCosimulation System object

Write System Object Test Bench

Write the test bench for use with the newly generated HDL cosimulation System object. The test bench you write might look similar to the example shown next.

```

3 % Sinus generator creation (F=100Hz, Sampling=1000Hz, complex fix point output)
4 SinGenerator = dsp.SineWave('Frequency ', 100, ...
5                             'Amplitude', 1, ...
6                             'Method', 'Table lookup', ...
7                             'SampleRate', 1000, ...
8                             'OutputDataType', 'Custom', ...
9                             'CustomOutputDataType', numerictype([], 10, 9), ..
10                            'ComplexOutput',true);
11
12 % HdlCosimulation System Object creation
13 fft_hdl = hdlcosim_fft_hdl;
14
15 % Simulate for 1000 samples
16 for ii=1:1000
17     % Read 1 sample from the sinus generator
18     ComplexSinus = step(SinGenerator);
19
20     % Send/receive 1 sample to/from the HDL FFT
21     [RealFft, ImagFft] = step(fft_hdl,real(ComplexSinus),imag(ComplexSinus));
22
23     % Store the FFT sample in a vector
24     ComplexFft(ii) = RealFft + ImagFft*1i;
25 end
26
27 % Discard the first 12 samples (initialization of the HDL FFT)
28 ComplexFft(1:12)=[];
29
30 % Display the FFT
31 plot(ComplexFft,'ro');
32 title('Fourier Coefficients in the Complex Plane');
33 xlabel('Real Axis');
34 ylabel('Imaginary Axis');
35
36 end

```

See “Import HDL Code for MATLAB System Object” on page 7-17 for a demonstration of creating a HDL cosimulation System object and test bench.

Run Cosimulation and Verify HDL Design

- 1 Launch the HDL simulator by executing the launch script created by the wizard (`launch_hdl_simulator_design_name.m`)
- 2 When the HDL simulator is ready, return to MATLAB and start the simulation by executing the test bench.
- 3 Verify the results.

Import HDL Code for HDL Cosimulation Block

In this section...

“Cosimulation Type—Simulink Block” on page 7-33

“HDL Files—Simulink Block” on page 7-35

“HDL Compilation—Simulink Block” on page 7-37

“Simulation Options—Simulink Block” on page 7-38

“Input/Output Ports—Simulink Block” on page 7-40

“Output Port Details—Simulink Block” on page 7-41

“Clock/Reset Details—Simulink Block” on page 7-43

“Start Time Alignment—Simulink Block” on page 7-44

“Generate Block” on page 7-46

“Complete Simulink Model” on page 7-47

Cosimulation Type—Simulink Block

If you have not yet done so, invoke the Cosimulation Wizard. See “Invoke the Cosimulation Wizard” on page 7-5.

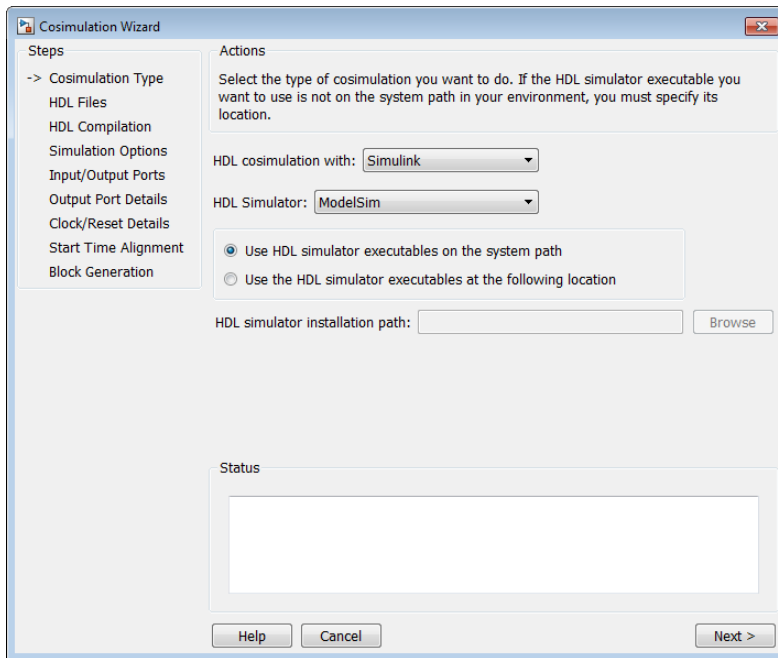

- 1 In the **Cosimulation Type** pane, select **Simulink** in the field **HDL cosimulation with** to instruct the wizard to create a Simulink block.
- 2 Select **ModelSim** or **Incisive** for the **HDL Simulator**.
- 3 Select **Use HDL simulator executables on the system path** if that is where the files are located. The Cosimulation Wizard assumes by default that they are on the system path.

If the HDL simulator executables are *not* on the system path, select **Use the following HDL simulator executables at the following location** and specify the folder location in the text box below.

If you click **Next** and the Cosimulation Wizard does not find the executables, the following occurs:

- You are returned to this dialog and the Cosimulation Wizard displays an error in the status pane.
- The Cosimulation Wizard switches the option to **Use the following HDL simulator executables at the following location**.

- The Cosimulation Wizard makes the HDL simulation path field editable.

You must enter a valid path to the HDL simulator executables before you are allowed to continue.

4 Click Next.

HDL Files — Simulink Block

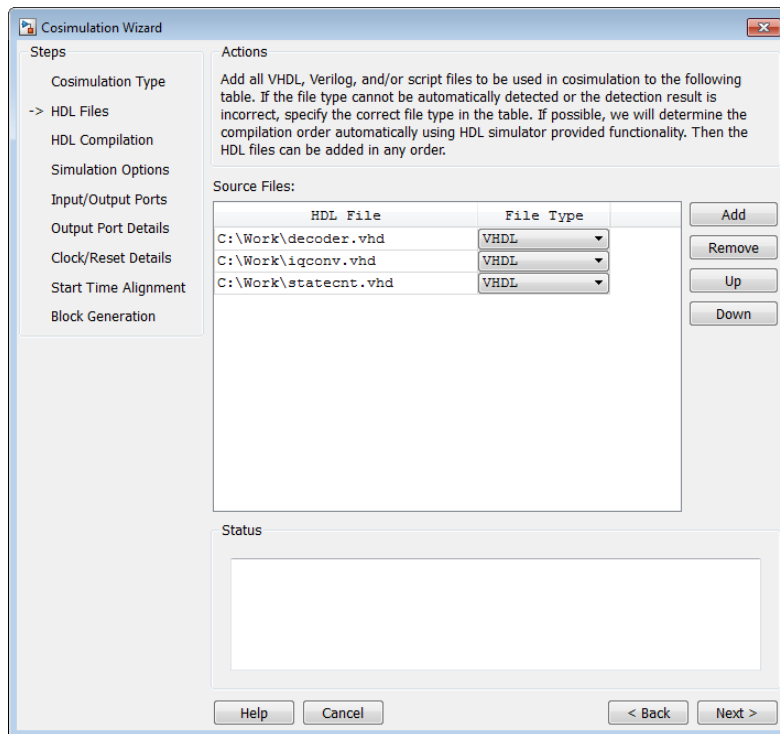

In the **HDL Files** pane, specify the files to be used in creating the function or block.

- The Cosimulation Wizard attempts to determine the file type of each file and display the type in the **File List** next to the file name. If the Cosimulation Wizard cannot determine the type or displays the wrong type, you can change the type directly in the **File Type** column.

- If possible, the Cosimulation Wizard will determine the compilation order automatically using HDL simulator provided functionality. This means you can add the files in any order.
 - If you are using ModelSim, you will see compilation scripts listed as .do files (ModelSim macro file). If you are using Incisive, you will see compilation scripts listed as system scripts.
- 1 Click **Add** to select one or more file names.
 - 2 Remove files by first highlighting the file name in the **File List**, then clicking **Remove Selected File**.
 - 3 Click **Next**.

HDL Compilation — Simulink Block

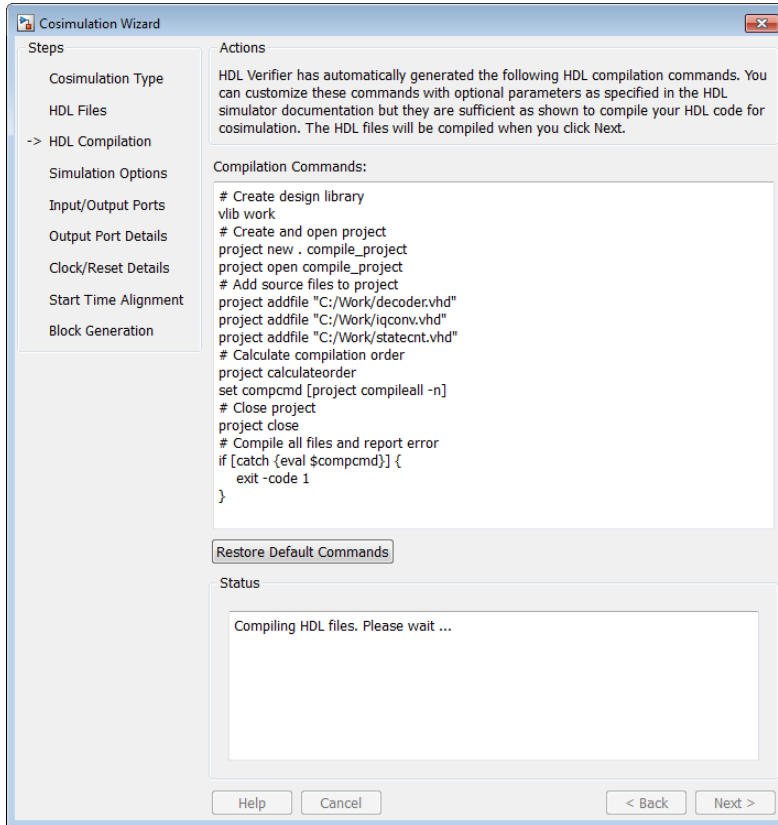

In the **HDL Compilation** pane, you can review the generated HDL compilation commands. You may override and/or customize those commands, if you wish. If you included compilation scripts instead of HDL files, this pane will show you the command to run those scripts.

- 1 Enter any changes to the commands in the **Compilation Commands** box.

Note: Do not include system shell commands; for example:

```
set file = a.vhd vcom $file
```

When control returns to the Cosimulation Wizard from executing the command, the variable no longer holds the value that was set. If you do try to include this type of command, you will see an error in the **Status** panel.

- 2 Click **Restore default commands** to go back to the generated HDL compilation commands. You are asked to confirm that you want to discard any changes.
- 3 Click **Next** to proceed.

Simulation Options—Simulink Block

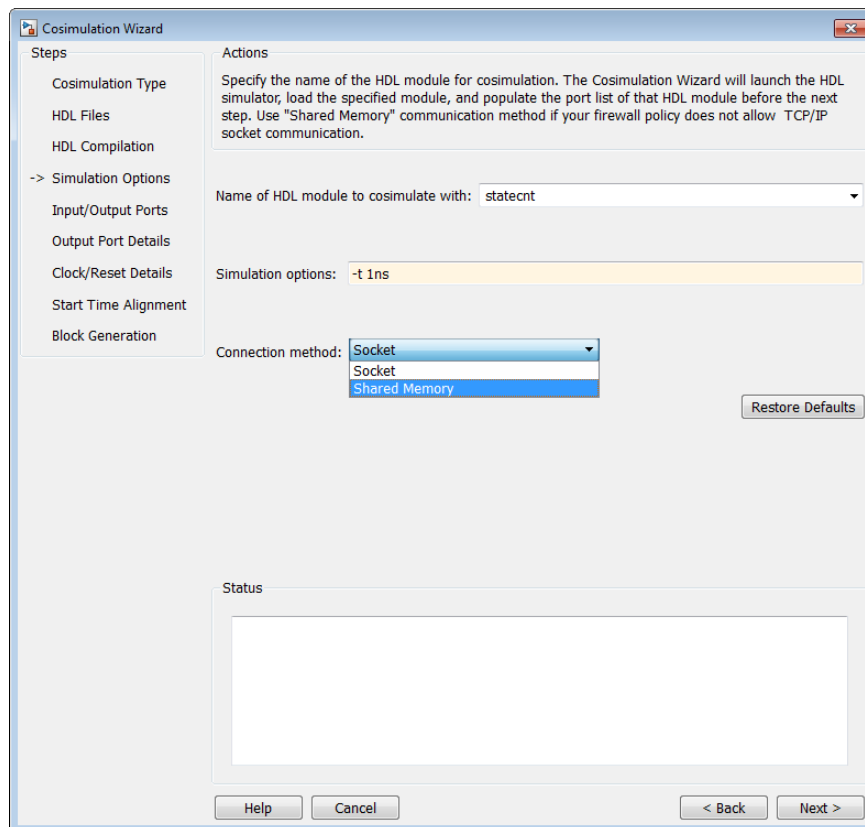

In the **Simulation Options** pane, provide the name of the HDL module to be used in cosimulation.

- 1 Enter the name of the module at **Name of HDL module to cosimulate with**.
- 2 Specify additional simulation options at **Simulation options**. For example, in the previous image, the options shown are:
 - HDL simulator resolution
 - Turn off optimizations that remove signals from the simulation view

Click **Restore Defaults** to change the options back to the default.

- 3 For **Connection method**, select **Shared Memory** if your firewall policy does not allow TCP/IP socket communication.
- 4 Click **Next** to proceed to the next step. At this time in the process, the application performs the following actions in a command window:
 - Starts the HDL simulator.
 - Loads the HDL module in the HDL simulator.
 - Starts the HDL server, and waits to receive notice that the server has started.
 - Connects with the HDL server to get the port information.
 - Disconnects and shuts down the HDL server.

Input/Output Ports—Simulink Block

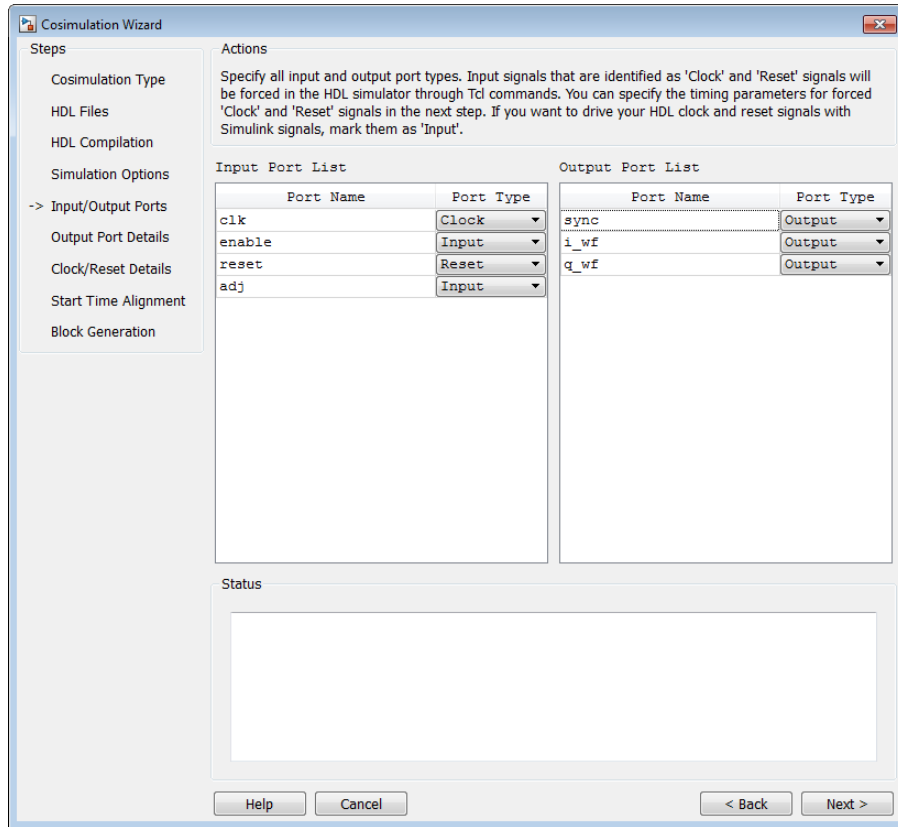

- In the **Simulink Ports** pane, specify the type of each input and output port.
 - The Cosimulation Wizard attempts to determine the port types for you, but you may override any setting.
 - For input ports, select Input, Clock, Reset, or Unused.
 - For output ports, select Output or Unused.
 - Simulink forces clock and reset signals in the HDL simulator through Tcl commands. You can specify clock and reset signal timing in a later step (see “Clock/Reset Details—Simulink Block” on page 7-43).

- To drive your HDL clock and reset signals with Simulink signals, mark them as **Input**.
- 2 Click **Next** to proceed to “Output Port Details—Simulink Block” on page 7-41.

Output Port Details—Simulink Block

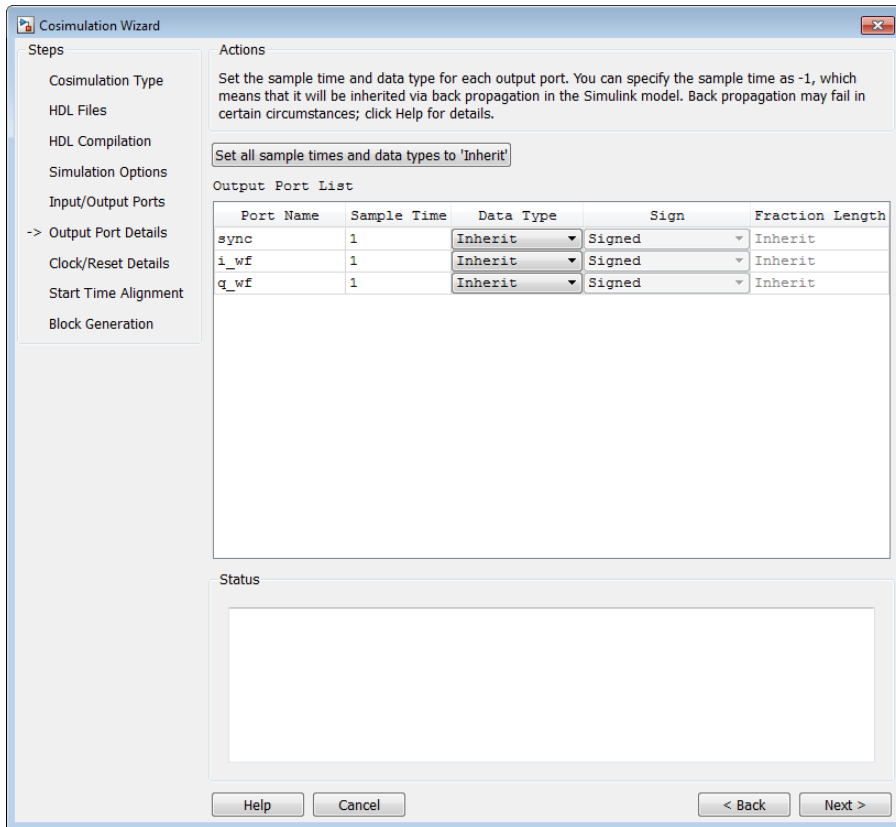

- 1 In the **Output Port Details** pane, set the sample time and data type for all output ports.
 - Sample time default is 1, the data type default is **Inherit** and **Signed**. These defaults are consistent with the way the HDL **Cosimulation** block mask (**Ports** tab) sets default settings for output ports.

- If you select **Set all sample times and data types to 'Inherit'**, the ports inherit the times via back propagation (sample times are set to -1). However, back propagation may fail in some circumstances; see “Backpropagation in Sample Times”.
- 2 Click **Next**.

Clock/Reset Details—Simulink Block

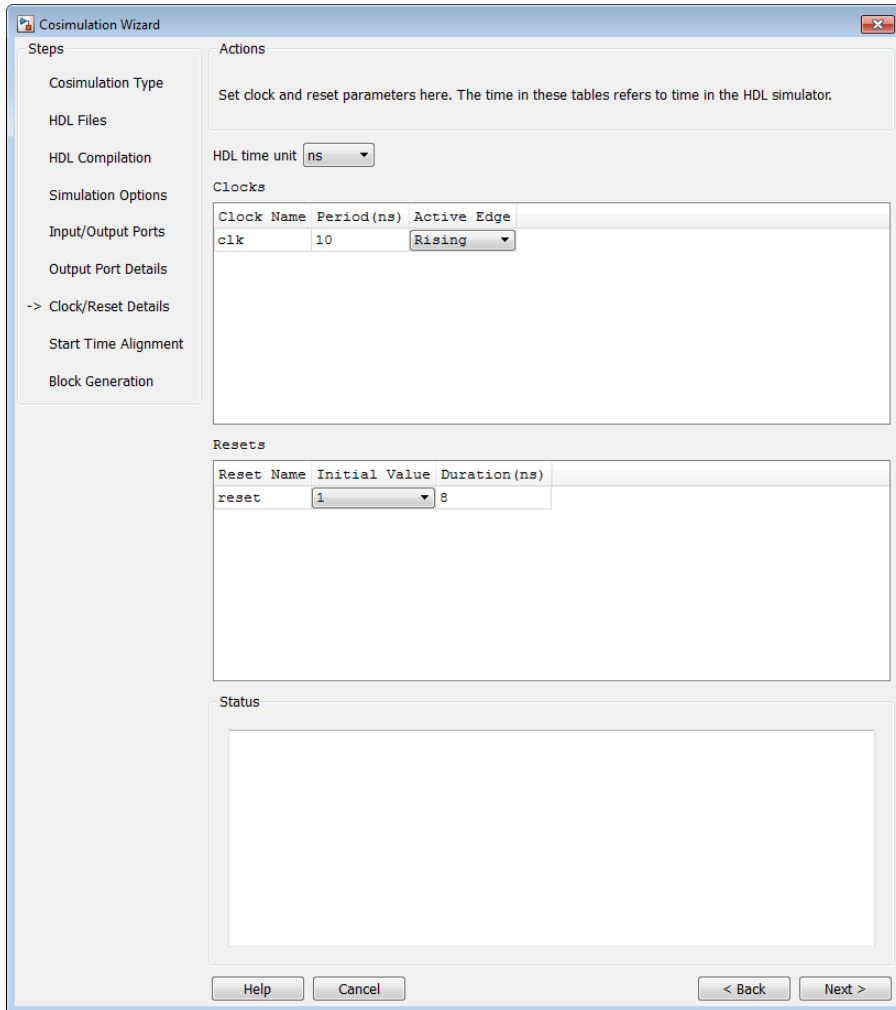

- 1 In the **Clock/Reset Details** pane, set the clock and reset parameters.
 - The time period specified here refers to time in the HDL simulator.
 - The clock default settings are a rising active edge and a period of 10 ns.
 - The reset default settings are an initial value of 0 and a duration of 15 ns.

The next screen provides a visual display of the simulation start time where you can review how the clocks and resets line up.

- 2 Click **Next**.

Start Time Alignment—Simulink Block

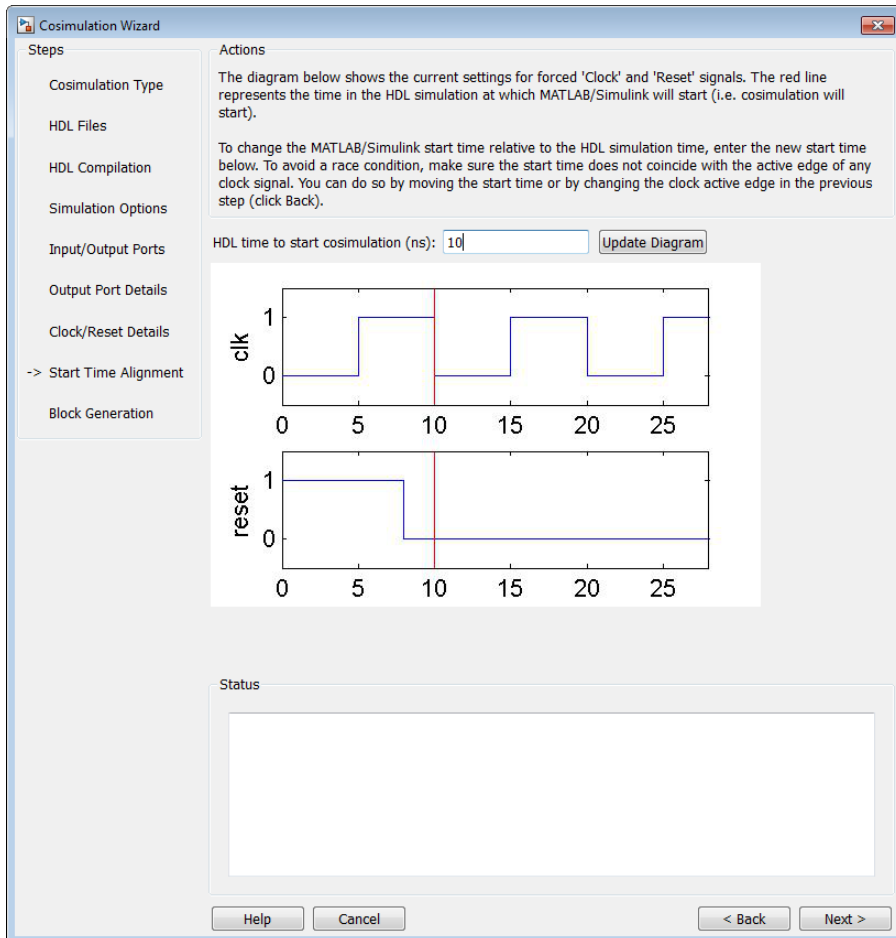

- 1 In the **Start Time Alignment** pane, review the current settings for clocks and resets. The purpose for this dialog is twofold:

- To make sure the rising or falling edge is set as expected (from the previous step)
 - Examine the start time. If it coincides with the active edge of the clock, you need to adjust the HDL simulator start time.
 - Examine the reset signal. If it is synchronous with the clock active edge, you may have a possible race condition.

To avoid a race condition, make sure the start time does not coincide with the active edge of any clocks. You can do this by moving the start time or by changing clock active edges in the previous step.

- To make sure the start time is where you want it.

The HDL simulator start time is calculated from the clock and reset values on the previous pane. If you want, you can change the HDL simulator start time by entering a new value where you see **HDL time to start cosimulation (ns)**. Click **Update plot** to see your change applied.

- 2 Click **Next**.

Generate Block

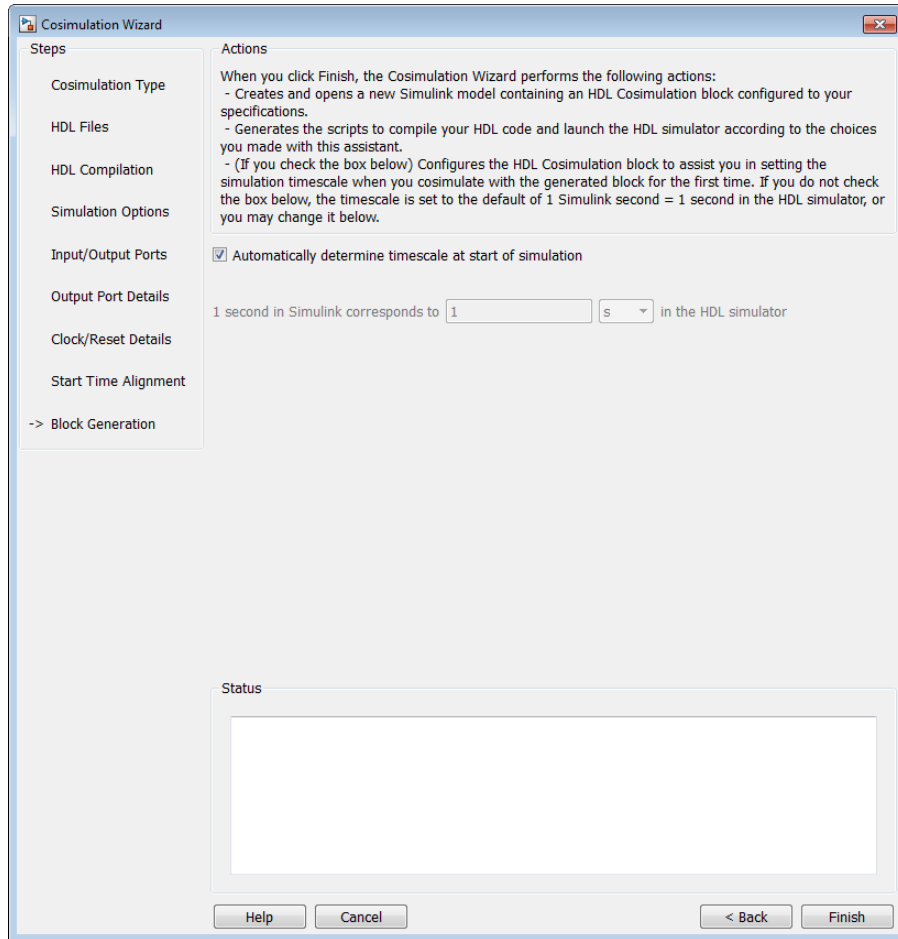

- 1 Specify if you want HDL Verifier to determine the timescale when you start the simulation by selecting **Automatically determine timescale at start of simulation**. If you prefer to determine the timescale yourself, leave this box unchecked and enter the timescale value in the text boxes below. The default is to automatically determine timescale.

For more about timescales, see the “Timescales Pane” section in the HDL Cosimulation block reference.

- 2 Click **Back** to review or change your settings.
- 3 Click **Finish** to generate the HDL cosimulation block.

Complete Simulink Model

The Cosimulation Wizard creates a new, untitled mode containing the HDL Cosimulation block and helper functions to compile HDL and launch the HDL simulator.

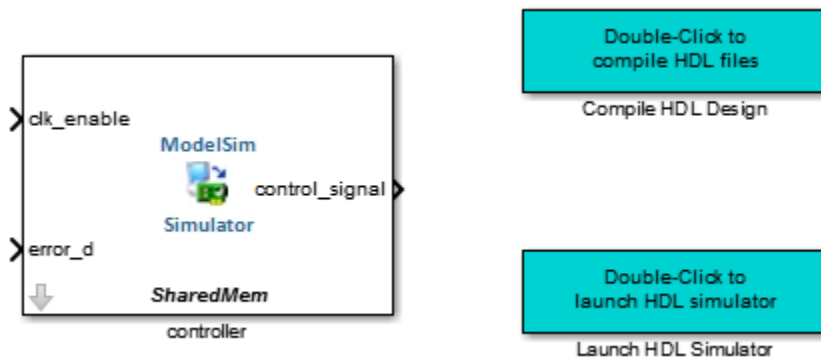

- 1 Copy the HDL Cosimulation block and, if you wish, the helper functions, from the newly generated model to the destination model.
- 2 Place the block so that the inputs and outputs to the HDL Cosimulation block line up.
- 3 Connect the blocks in the destination model to the HDL Cosimulation block.

When you have completed the model, see “Performing Cosimulation” on page 7-48 for the next steps in HDL cosimulation.

Performing Cosimulation

When you are finished creating a function, System object, or block, select the topic below that describes how you are planning to cosimulate your HDL code.

If you generated this cosimulation interface:	Select one of these topics:
MATLAB test bench function (<code>matlabtb</code>)	<ul style="list-style-type: none"> • With a completed test bench, you can start at the next step: “Place Test Bench on MATLAB Search Path” on page 1-18 • Review entire test bench function workflow: “MATLAB as a Test Bench” on page 1-2
MATLAB component function (<code>matlabcp</code>)	<ul style="list-style-type: none"> • With a completed component, you can start at the next step: “Place Component Function on MATLAB Search Path” on page 2-12 • Review entire test bench function workflow: “MATLAB Function as a Component” on page 2-2
MATLAB System object	<p>With a completed System object, you are ready to use it for HDL verification. See “Verify Viterbi Decoder Using MATLAB System Object and Mentor Graphics ModelSim” on page 3-3 for an example of using the MATLAB System object for HDL cosimulation.</p>
Simulink Block	<p>With a completed HDL cosimulation block, you can continue with one of the following topics:</p> <ul style="list-style-type: none"> • “Run a Test Bench Cosimulation Session” on page 4-42 • “Run a Component Cosimulation Session” on page 5-41 <p>In either workflow, you must place your HDL cosimulation block within a test bench or component model.</p>

If you generated this cosimulation interface:	Select one of these topics:
	See “Create Simulink Model for Test Bench Cosimulation” on page 4-8 or “Create Simulink Model for Component Cosimulation” on page 5-10.

You can also view the following examples:

- “Verify Raised Cosine Filter Design Using MATLAB” on page 7-69
- “Verify Raised Cosine Filter Design Using Simulink” on page 7-84

Cosimulation Wizard for MATLAB System Object

This example guides you through the basic steps for setting up an HDL Verifier™ application using the Cosimulation Wizard.

This example uses a MATLAB System object and ModelSim to verify a register transfer level (RTL) design of a Fast Fourier Transform (FFT) of size 8 written in Verilog. The FFT is commonly used in digital signal processing to produce frequency distribution of a signal.

To verify the correctness of this FFT, a MATLAB System object testbench is provided. This testbench generates a periodic sinusoidal input to the HDL design under test (DUT) and plots the Fourier Coefficients in the Complex Plane.

The Cosimulation Wizard takes the provided Verilog file of this FFT as its input. It also collects user input required for setting up cosimulation in each step. At the end of the example, the Cosimulation Wizard generates a MATLAB script that instantiates a configured `HdlCosimulation` System object, a MATLAB script that compiles HDL design, and a MATLAB script that launches the HDL simulator for cosimulation.

1. Set Up Example Files

To ensure that others can access copies of the example files, set up a folder for your own example work by following these instructions:

a. Create a folder outside the scope of your MATLAB installation folder into which you can copy the example files. The folder must be writable. This example assumes that you create a folder named 'MyTests'.

b. Copy all the files located in the following directory to the folder you created:

```
matlabroot\toolbox\edalink\foundation\hdlink\demo_src\tutorial_fft
```

c. You now have all the example files you need in your working directory:

- `fft_tb.m`
- `fft_hdl.v`
- `fft_hdl_tc.v`

2. Launch Cosimulation Wizard

a. Start MATLAB.

b. Set the directory you created in **Set Up Example Files** as your current directory in MATLAB.

c. At the MATLAB command prompt, enter the following:

```
>>cosimWizard
```

The command launches the Cosimulation Wizard.

3. Specify Cosimulation Type

In the Cosimulation Type page, perform the following steps:

a. Change **HDL cosimulation** with option set to **MATLAB System Object**.

b. If you are using ModelSim, change **HDL Simulator** option as **ModelSim**.

c. Leave the default option **Use HDL simulator executables on the system path** option if the HDL simulator executables appear on your system path. If these executable do not appear on the path, specify the HDL simulator path.

d. Click **Next** to proceed to the HDL Files page.

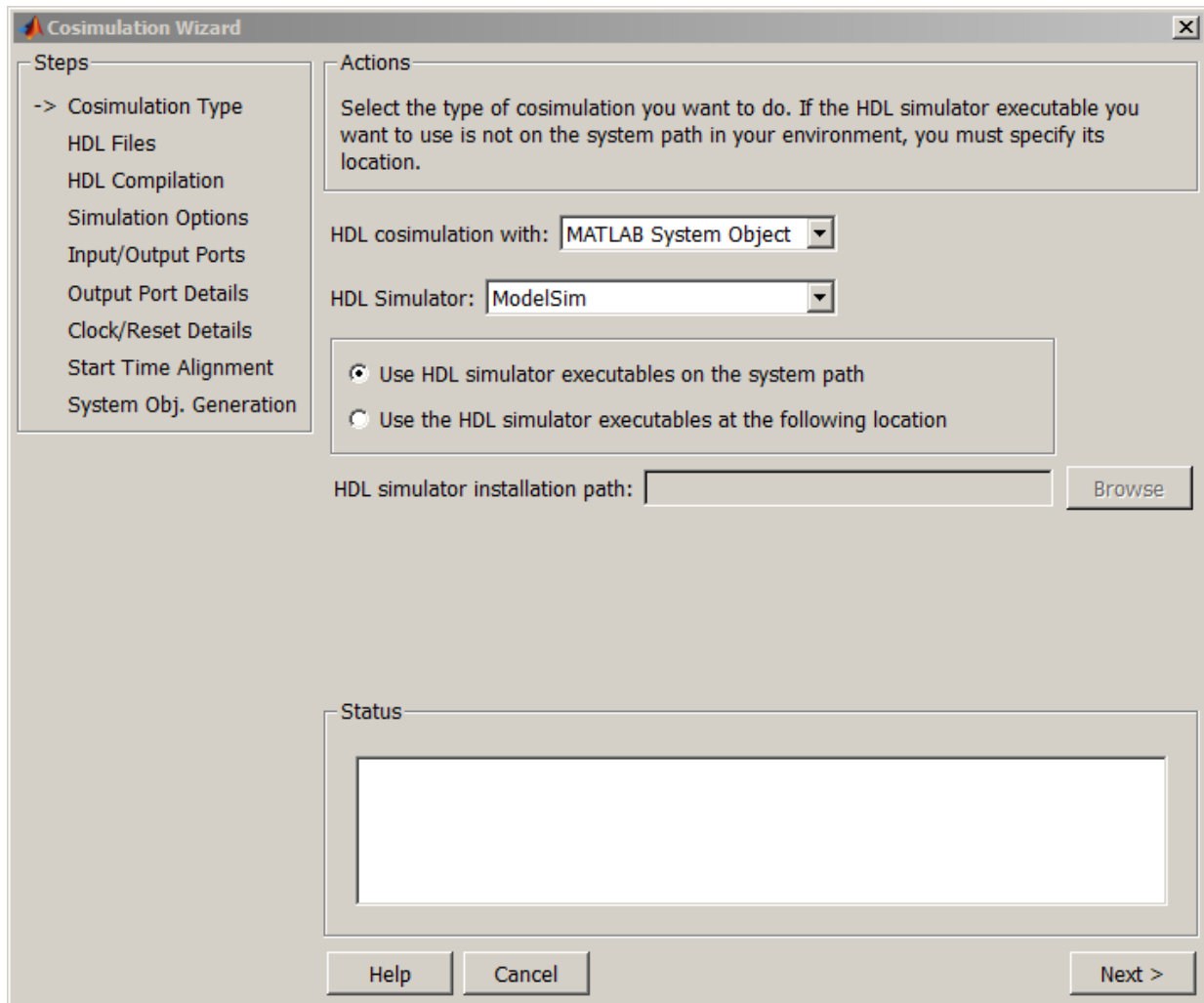

4. Select HDL Files

In the HDL Files page, perform the following steps:

a. Add HDL files to file list:

- Click **Add** and select the Verilog files **fft_hdl.v** and **fft_hdl_tc.v** in your example folder.

- Review the files in the file list to make sure the file type is correctly identified.

b. Click **Next** to proceed to the HDL Compilation page.

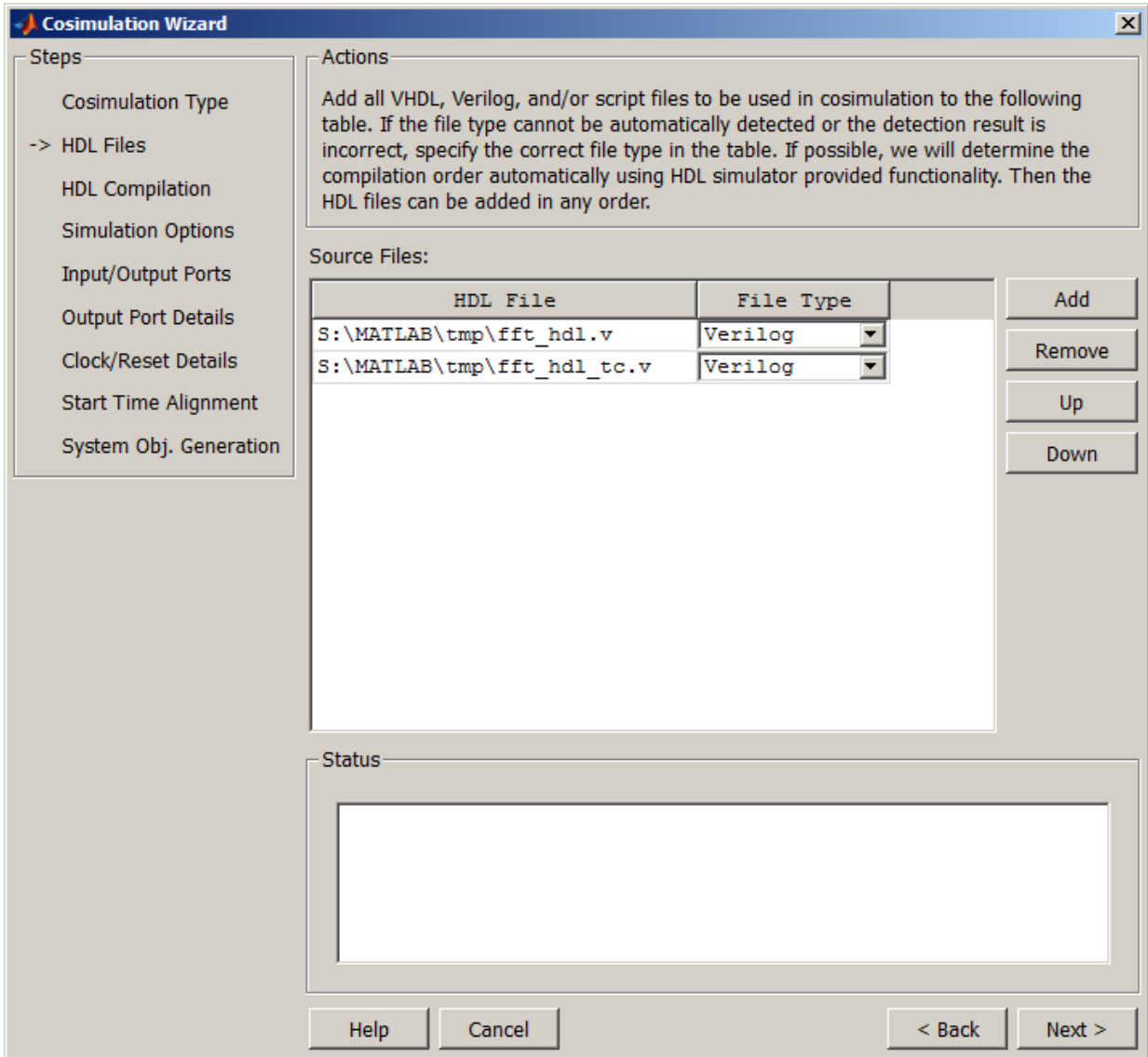

5. Specify HDL Compilation Commands

The Cosimulation Wizard lists the default commands in the Compilation Commands window. You do not need to change these commands for this example.

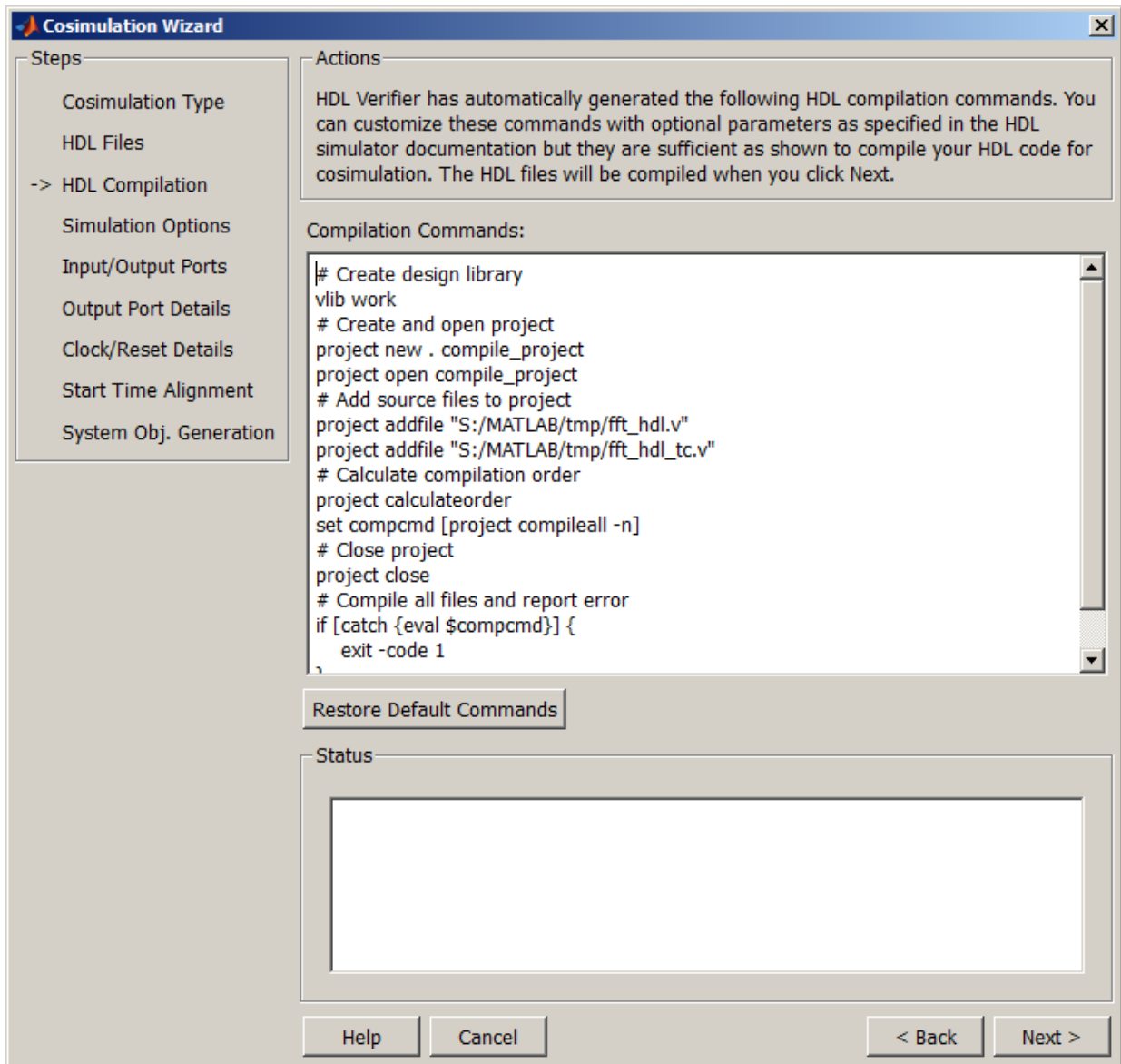

Click **Next**. The MATLAB console displays the compilation log. If an error occurs during compilation, that error appears in the Status area. Correct the error before proceeding to the next step.

6. Select HDL Modules for Cosimulation

In the HDL Modules page, perform the following steps:

a. Specify the name of HDL module/entity for cosimulation. From the drop-down list, select **fft_hdl**. This module is the Verilog module you use for cosimulation. If you do not see "fft_hdl" in the drop-down list, you can enter the file name manually.

b. In the Simulation options field, remove the -novopt option so that ModelSim can optimize the HDL design.

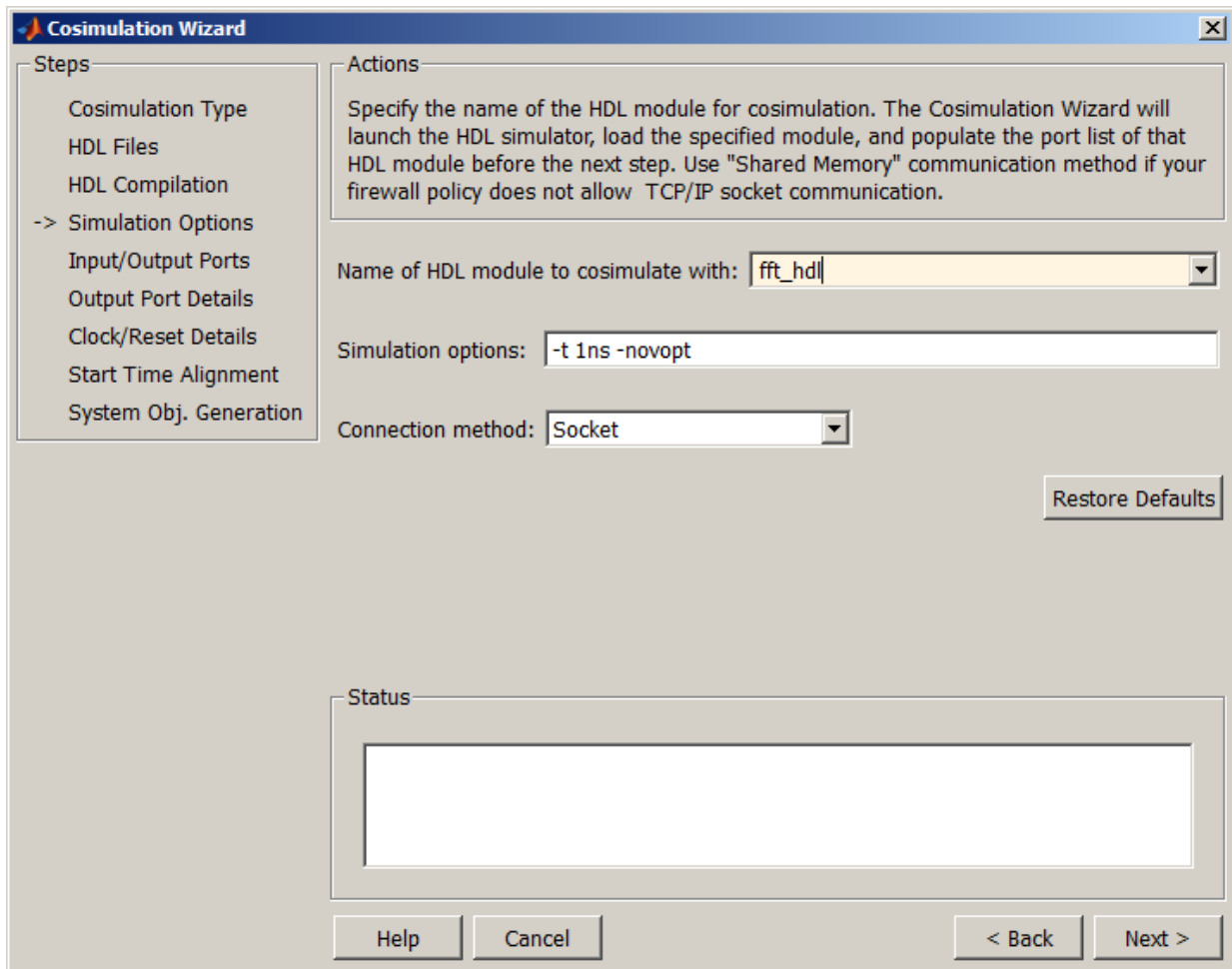

c. Click **Next**. The Cosimulation Wizard launches the HDL simulator in the background console using the specified HDL module and simulation options. If the wizard launches the HDL simulator successfully, the wizard populates the input and output ports on the Verilog model `fft_hdl` and displays them in the next step.

7. Specify Input/Output Port Types

In this step, the Cosimulation Wizard displays two tables containing the input and output ports of `fft_hdl`, respectively.

The Cosimulation Wizard attempts to correctly identify the port type for each port. If the wizard incorrectly identifies a port, you can change the port type using these tables.

- For input ports, you can select from Clock, Reset, Input, or Unused. HDL Verifier connects only the input ports marked "Input" to MATLAB during cosimulation.
- HDL Verifier connects output ports marked Output with MATLAB during cosimulation. The link software and MATLAB ignore those output ports marked "Unused during cosimulation.
- You can change the parameters for signals identified as "Clock" and "Reset" at a later step.

Accept the default port types and click **Next** to proceed to the Output Port Details page.

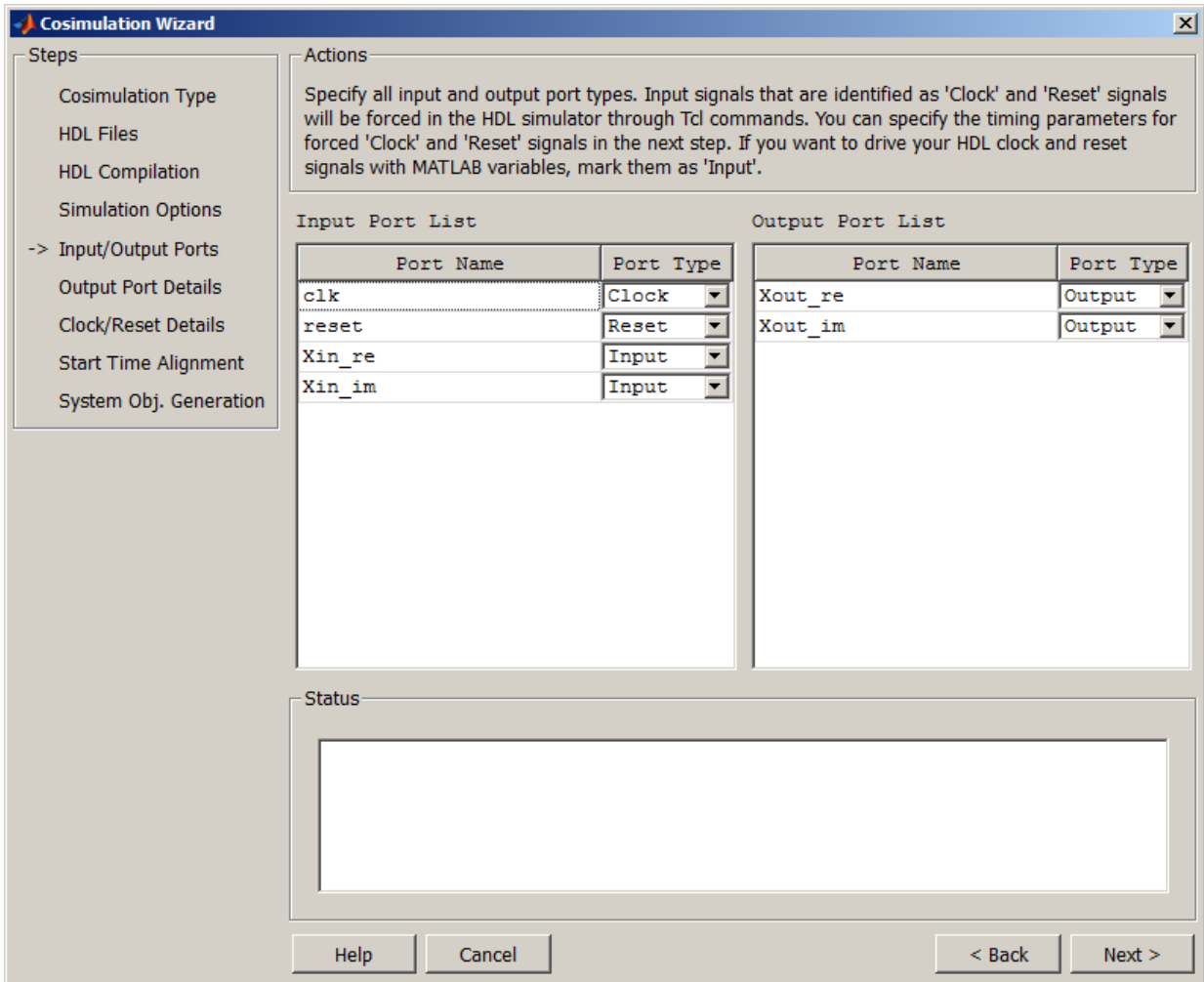

8. Specify Output Port Details

For this example, the HDL FFT outputs are signed, 13 bits long with 9 bits of fraction length. In the Output Port Details page, perform the following steps:

- Note that the **Sample Time** can not be changed and is always fixed to 1 with the HdIcosimulation System object .

- b. Change the **Data Type** to **Signed** for both outputs
- c. Change the **Fraction Length** to **9** for both outputs
- c. Click **Next** to proceed to the Clock/Reset Details page.

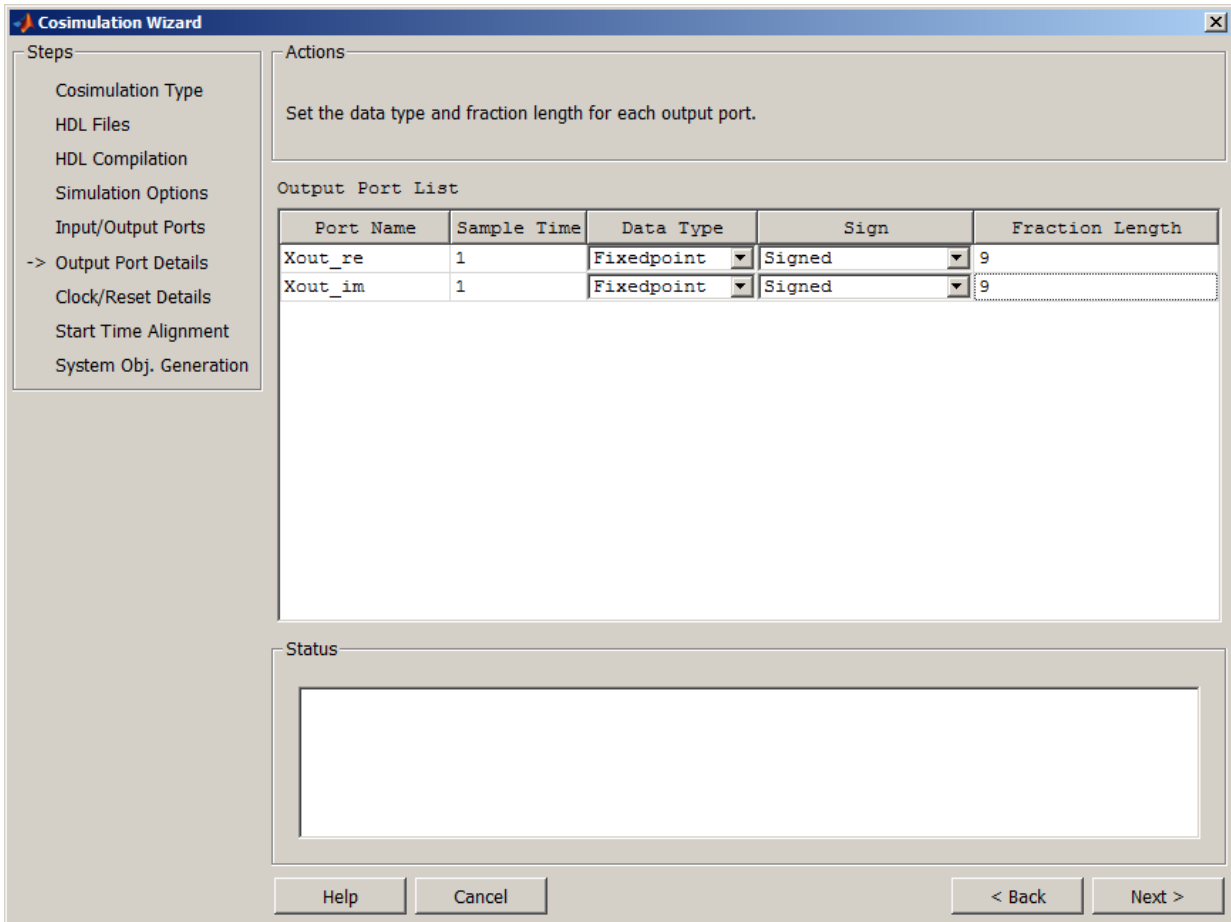

9. Set Clock and Reset Details

Set the clock Period (ns) to 20. From the Verilog code, you know that the reset is synchronous and the active value is 1. You can reset the entire HDL design at time 1 ns,

triggered by the rising edge of the clock. Use a duration of 15 ns for the reset signal. In the Clock/Reset Details page, perform the following steps:

- a. Set clock period to 20.
- b. Leave or set active edge to Rising.
- c. Leave or set reset initial value to 1.
- d. Set reset signal duration to 15.

Click **Next** to proceed to the Start Time Alignment page.

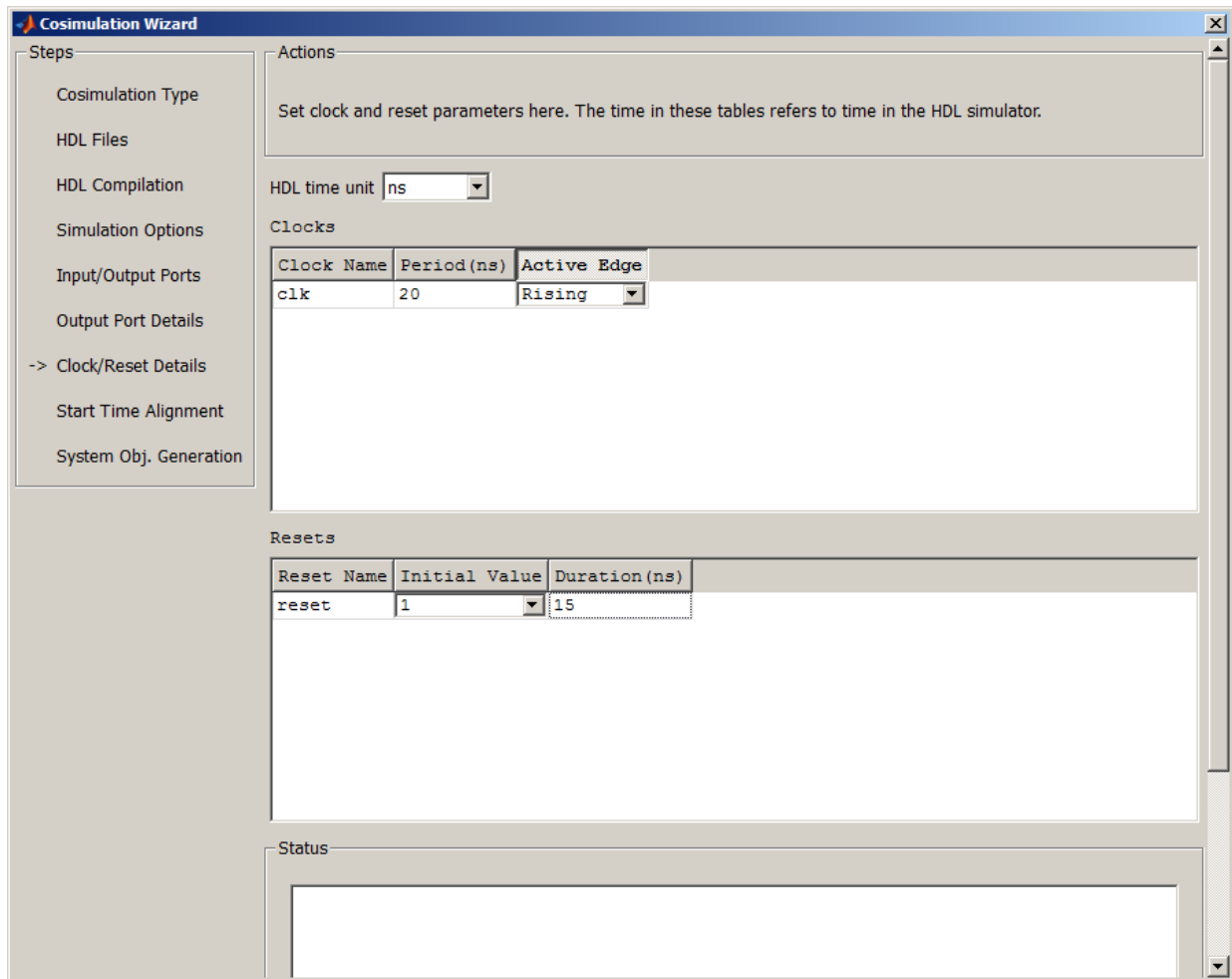

10. Confirm Start Time Alignment

The Start Time Alignment page displays a plot for the waveforms of clock and reset signals. The Cosimulation Wizard shows the HDL time to start cosimulation with a red line. The start time is also the time at which the System object gets the first input sample from the HDL simulator. The active edge of clock is a rising edge. Thus, at time 20 ns in the HDL simulator, the registered output of the FFT is stable. No race condition exists, and the default HDL time to start cosimulation (20 ns) is correct.

Click **Next** to proceed to System Object Generation.

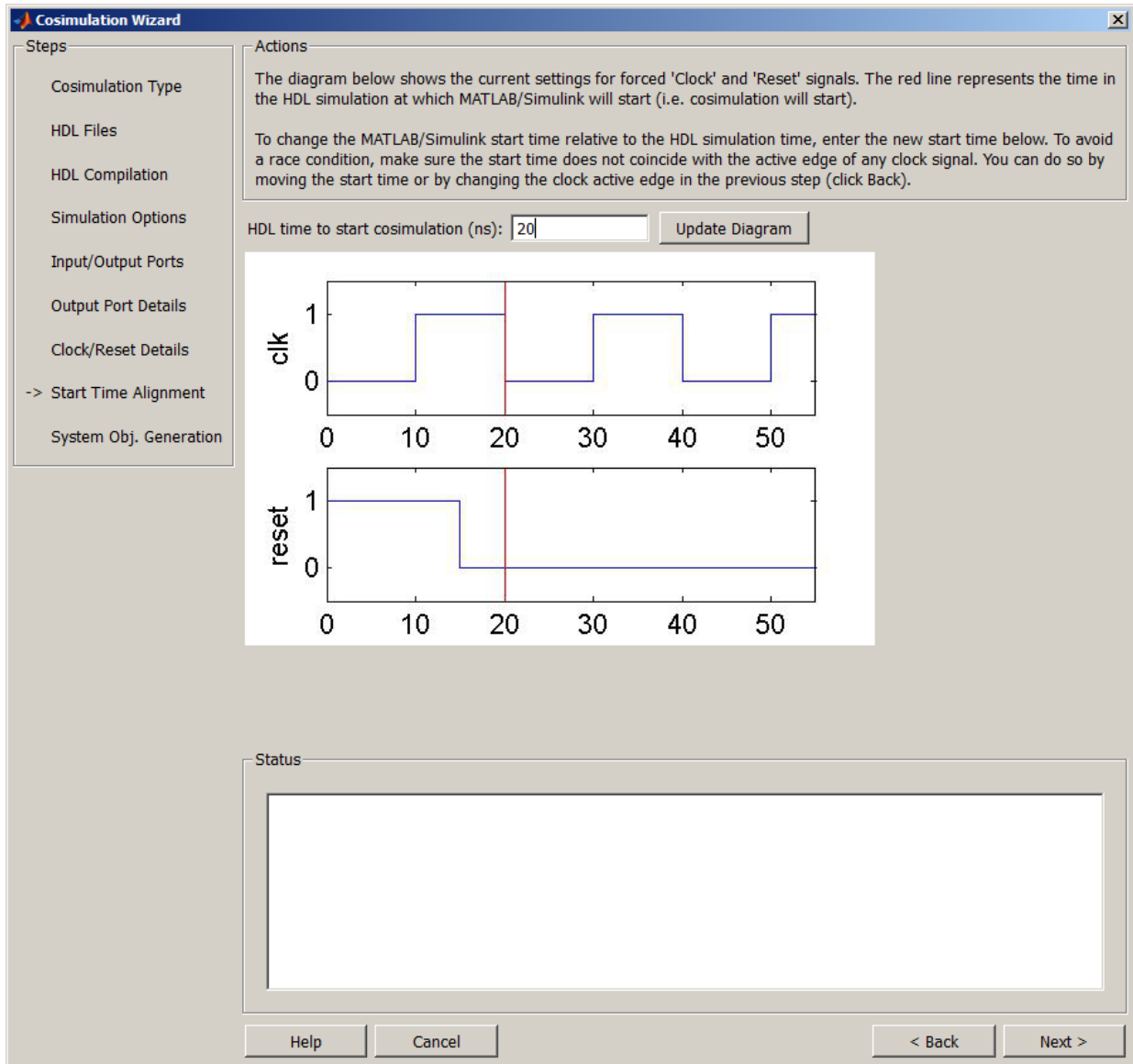

11. Generate System Object

a. Before Cosimulation Wizard generates the scripts, you have the option to modify the HDL Simulator sampling period. The sampling period determine the elapsed time in the HDL Simulator separating each call to step in MATLAB. Most of the time the sampling period is equal to the clock period. You can also specify if your inputs/outputs are frame based (instead of sample based).

b. Click **Finish** to complete the Cosimulation Wizard session.

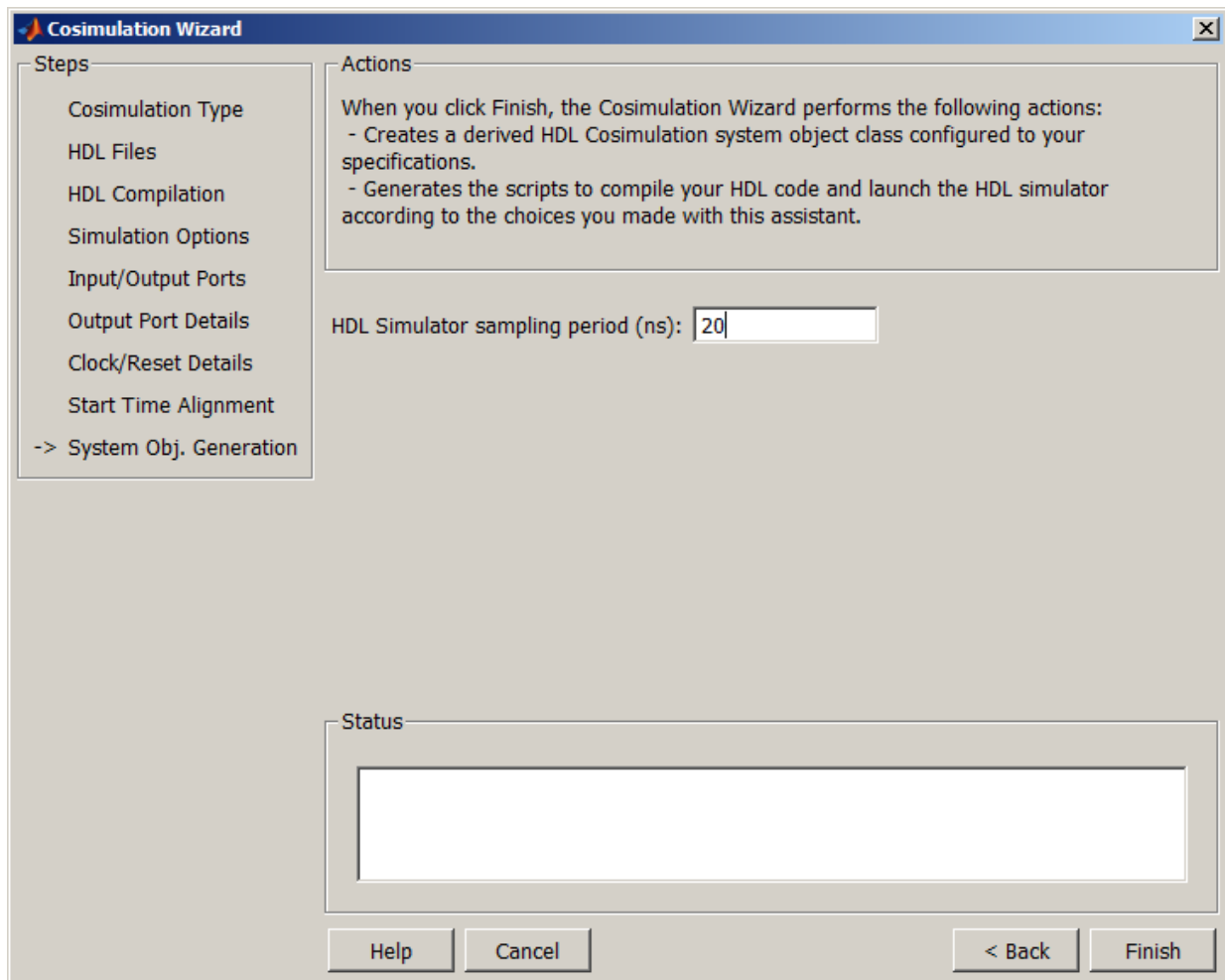

12. Create Test Bench to Verify HDL Design

For this example, you do not actually create the test bench. Instead, you can find the finished script **fft_tb.m** in the directory you created in **Set Up Example Files**.

a. After you click **Finish** in the Cosimulation Wizard, the application generates three HDL files in the current directory:

- **compile_hdl_design_fft_hdl.m**: To recompile the HDL design
- **launch_hdl_simulator_fft_hdl.m**: To relaunch the MATLAB System object server and start the HDL simulator.
- **hdlcosim_fft_hdl.m**: To create the HdlCosimulation System object

b. Open the files **fft_tb.m** and **hdlcosim_fft_hdl.m**, located in the directory you created in **Set Up Example Files** and observe the HdlCosimulation System object calls.

hdlcosim_fft_hdl.m contains the HdlCosimulation instantiation and **fft_tb.m** contains a MATLAB System object test bench. You will use this test bench to verify the HDL design for which you just generated a corresponding HdlCosimulation System object .

13. Run Cosimulation and Verify HDL Design

a. Launch the HDL simulator by executing the script **launch_hdl_simulator_fft_hdl.m**.

```
>>launch_hdl_simulator_fft_hdl.m
```

b. When the HDL simulator is ready, return to MATLAB and start the simulation by executing the script **fft_tb.m**.

```
>>fft_tb.m
```

c. Verify the result from the plot in the test bench. The plot display the Fourier Coefficients in the Complex Plane.

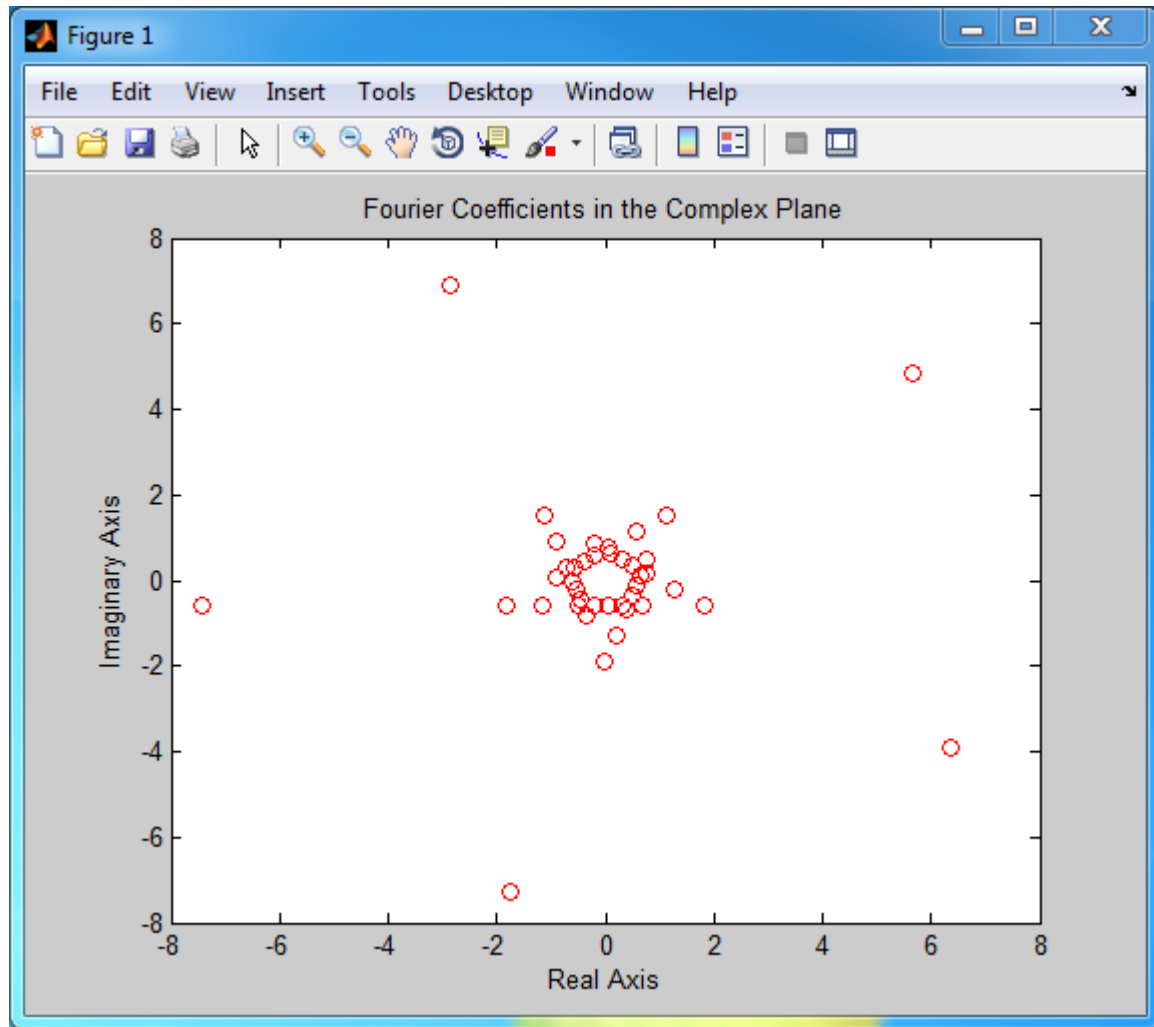

This concludes the Cosimulation Wizard for use with MATLAB System object example.

Verify Raised Cosine Filter Design Using MATLAB

In this section...
“MATLAB and Cosimulation Wizard Tutorial Overview” on page 7-69
“Tutorial: Set Up Tutorial Files (MATLAB)” on page 7-70
“Tutorial: Launch Cosimulation Wizard (MATLAB)” on page 7-71
“Tutorial: Configure the Component Function with the Cosimulation Wizard” on page 7-71
“Tutorial: Customize Callback Function” on page 7-78
“Tutorial: Run Cosimulation and Verify HDL Design” on page 7-82

MATLAB and Cosimulation Wizard Tutorial Overview

This tutorial guides you through the basic steps for setting up an HDL Verifier cosimulation that uses MATLAB and the HDL Simulator. This cosimulation verifies an HDL design using a MATLAB component as the test bench. In this tutorial, you perform the steps to cosimulate MATLAB with the HDL simulator to verify the suitability of a raised cosine filter written in Verilog.

Note: This tutorial requires MATLAB, the HDL Verifier software, and the ModelSim or Incisive HDL simulator. This tutorial also assumes that you have read “Import HDL Code for MATLAB Function” on page 7-6.

The HDL test bench instantiates two raised-cosine filter components: one is implemented in HDL, and the other is associated with a MATLAB callback function. The test bench also generates stimulus to both filters and compares their outputs.

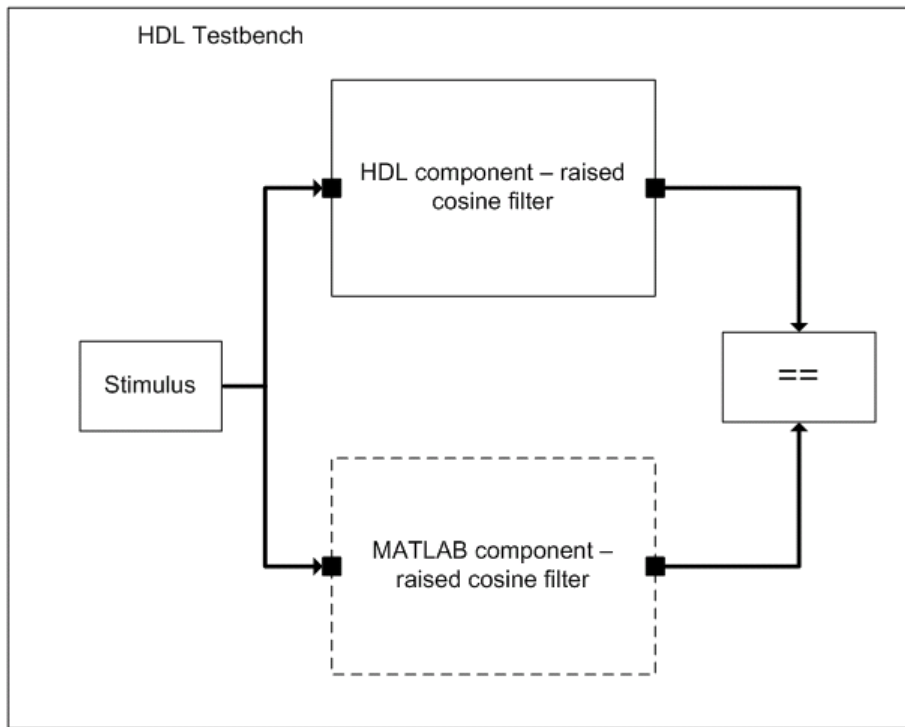

Tutorial: Set Up Tutorial Files (MATLAB)

To help others access copies of the tutorial files, set up a folder for your own tutorial work by following these instructions:

- 1 Create a folder outside the scope of your MATLAB installation folder into which you can copy the tutorial files. The folder must be writable. This tutorial assumes that you create a folder named `MyTests`.
- 2 Copy all the files located in the following MATLAB folder to the folder you created:

```
matlabroot\toolbox\edalink\foundation\hdl1ink\demo_src\tutorial
```

where *matlabroot* is the MATLAB root directory on your system.

- 3 You now have the following files in your working folder:

- `filter_tb.v`

- mycallback_solution.m
- rcosflt_beh.v
- rcosflt_rtl.v
- rcosflt_tb.mdl (not used in this tutorial)

Tutorial: Launch Cosimulation Wizard (MATLAB)

- 1 Start MATLAB.
- 2 Set the folder you created in “Tutorial: Set Up Tutorial Files (MATLAB)” on page 7-70 as your current folder in MATLAB.
- 3 At the MATLAB command prompt, enter:

```
>>cosimWizard
```

This command launches the Cosimulation Wizard.

Tutorial: Configure the Component Function with the Cosimulation Wizard

This tutorial leads you through the following wizard pages, designed to assist you in creating an HDL Verifier component function:

- “Tutorial: Specify Cosimulation Type (MATLAB)” on page 7-71
- “Tutorial: Select HDL Files (MATLAB)” on page 7-72
- “Tutorial: Specify HDL Compilation Commands (MATLAB)” on page 7-73
- “Tutorial: Select HDL Modules for Cosimulation (MATLAB)” on page 7-75
- “Tutorial: Specify Callback Schedule” on page 7-76
- “Tutorial: Generate Script” on page 7-77

Tutorial: Specify Cosimulation Type (MATLAB)

In the Cosimulation Type page, perform the following steps:

- 1 Change **HDL cosimulation with** option set to MATLAB.
- 2 If you are using ModelSim, leave **HDL Simulator** option as ModelSim.
If you are using Incisive, change **HDL Simulator** option to Incisive.
- 3 Leave the default option **Use HDL simulator executables on the system path** option if the HDL simulator executables appear on your system path.

If the executables do not appear in the path, specify the HDL simulator path as described in “Cosimulation Type—MATLAB Function” on page 7-6.

4

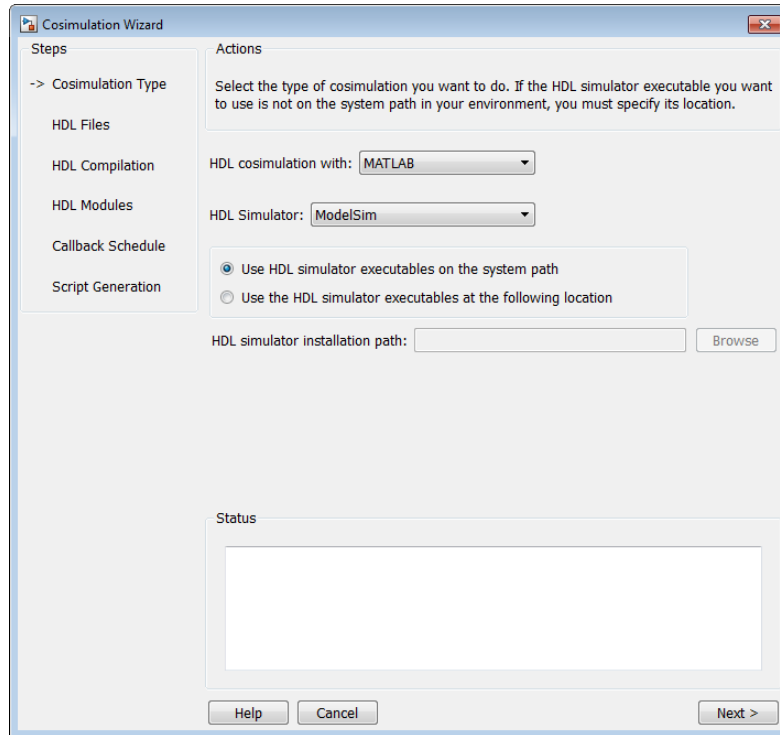

5 Click **Next** to proceed to the HDL Files page.

Tutorial: Select HDL Files (MATLAB)

In the HDL Files page, perform the following steps:

1 Add HDL files to file list.

- a Click **Add** and browse to the directory you created in “Tutorial: Set Up Tutorial Files (MATLAB)” on page 7-70.
- b Select the Verilog[®] files `filter_tb.v`, `rcosflt_rtl.v`, and `rcosflt_beh.v`. You can select multiple files in the file browser by holding down the **CTRL** key while selecting the files with the mouse.

- c Review the file in the file list with the file type identified as you expected.

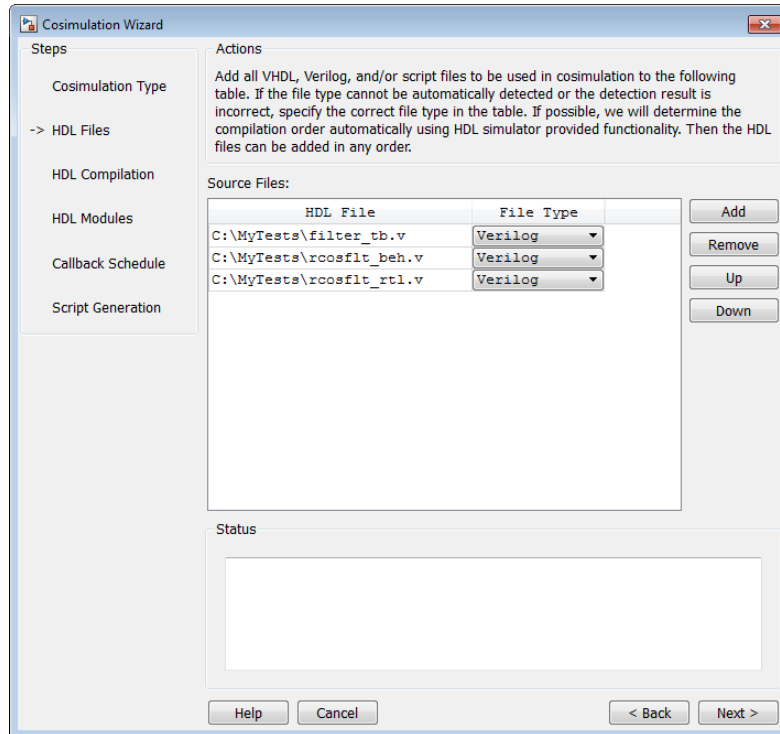

- 2 Click **Next** to proceed to the HDL Compilation page.

Tutorial: Specify HDL Compilation Commands (MATLAB)

Cosimulation Wizards lists the default commands in the Compilation Commands window. You do not need to change these defaults for this tutorial.

- 1 Examine compilation commands.
- a ModelSim users: Your HDL Compilation pane looks similar to the following.

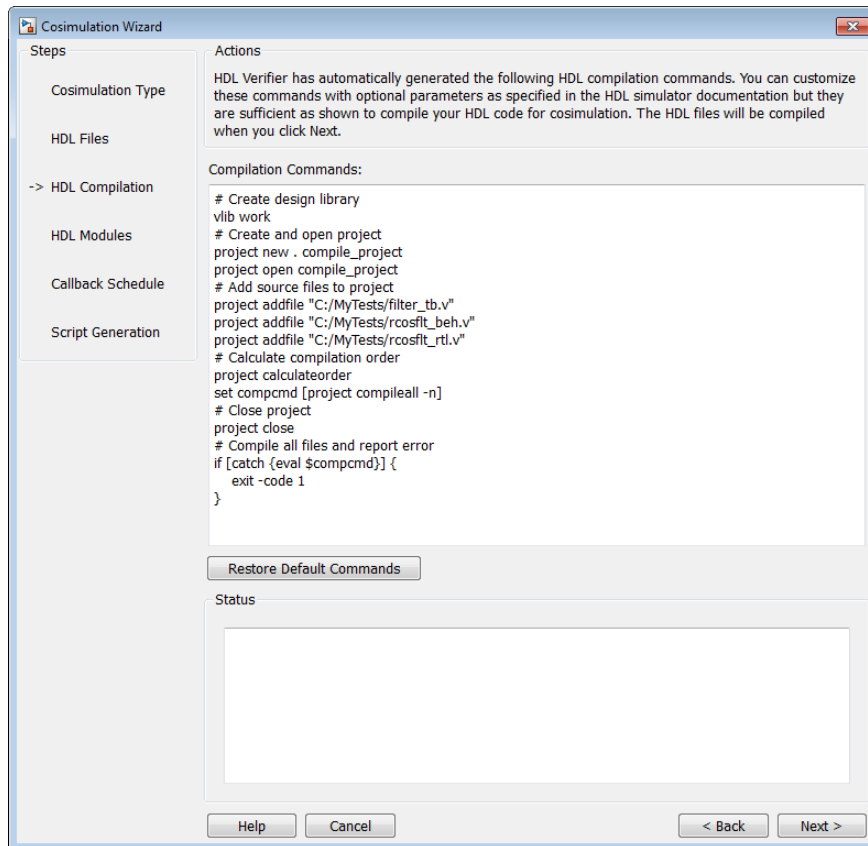

- b** Incisive users: Your HDL Compilation commands will look similar to the following:

```
ncvlog -update "/mathworks/home/user/MyTests/filter_tb.v"
ncvlog -update "/mathworks/home/user/MyTests/rcosflt_beh.v"
ncvlog -update "/mathworks/home/user/MyTests/rcosflt_rtl.v"
```

- 2** Click **Next** to proceed to the HDL Modules pane.

The MATLAB console displays the compilation log. If an error occurs during compilation, that error appears in the Status area. Change whatever settings you can to remove the error before proceeding to the next step.

Tutorial: Select HDL Modules for Cosimulation (MATLAB)

In the HDL Modules pane, perform the following steps:

- 1 Specify the name of the HDL module/entity for cosimulation.

At **Name of HDL module to cosimulate with**, select `filter_tb` from the drop-down list to specify the Verilog module you will use for cosimulation.

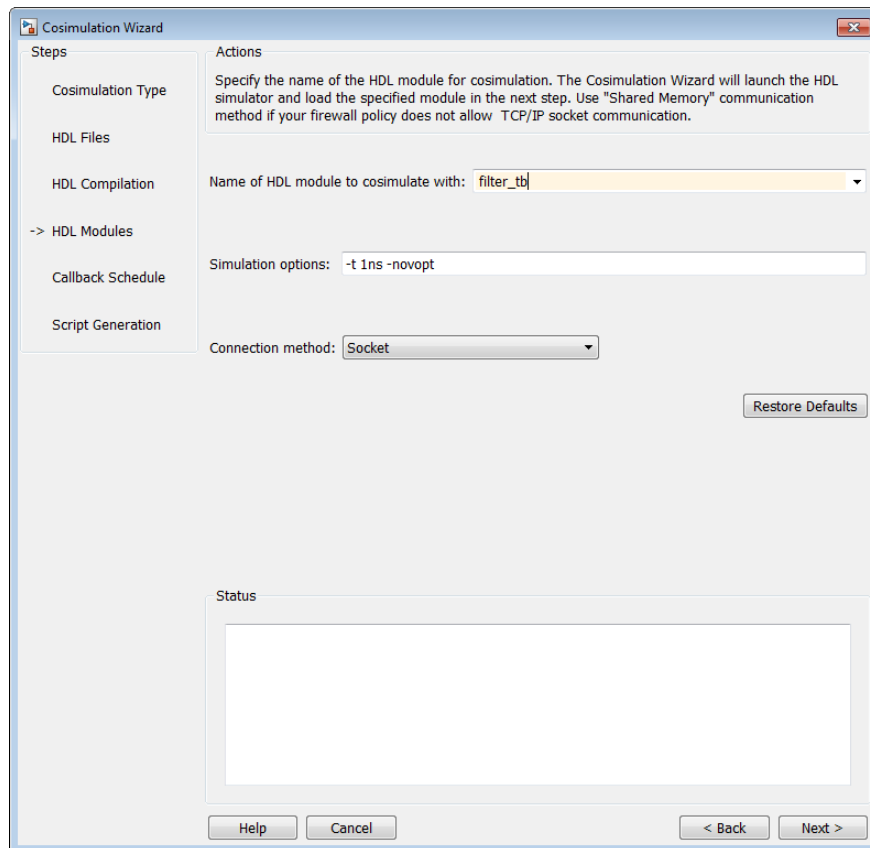

If you do not see `filter_tb` in the drop-down list, you can enter it manually.

- 2 For **Connection method**, select **Shared Memory** if your firewall policy does not allow TCP/IP socket communication.
- 3 Click **Next** to proceed to the Callback Schedule page.

Cosimulation Wizard launches the HDL simulator in the background console using the specified HDL module and simulation options. After the wizard launches the HDL simulator, the Callback Schedule page appears. On Windows systems, the console remains open. Do not close the console; the application closes this window upon completion.

Tutorial: Specify Callback Schedule

In the Callback Schedule page, perform the following steps:

- 1 Leave **Callback type** as `matlabcp` (default). This type instructs the Cosimulation Wizard to create a MATLAB callback function as a component for cosimulation with the HDL simulator.
- 2 Leave **Callback function name** as `callback_fcn`. The wizard gives this name to the generated MATLAB callback function.
- 3 For **HDL component**, click **Browse**. Click the expander icon next to `filter_tb` to expand the selection. Select `u_rcosflt_beh`, and click **OK**. You have specified to the Cosimulation Wizard that the HDL simulator associate this component with the MATLAB callback function.
- 4 Set **Trigger mode** to **Rising Edge**.
- 5 For **Trigger Signal**, click **Browse**. Click the expander icon next to `filter_tb` to expand the selection. Select `u_rcosflt_beh`. In the ports list on the right, select `clk`. Click **OK**.
- 6 Click **Add**. The Cosimulation Wizard generates the corresponding `matlabcp` command that associates the HDL module `u_rcosflt_beh` with the MATLAB function `callback_fcn`, as shown in the following image:

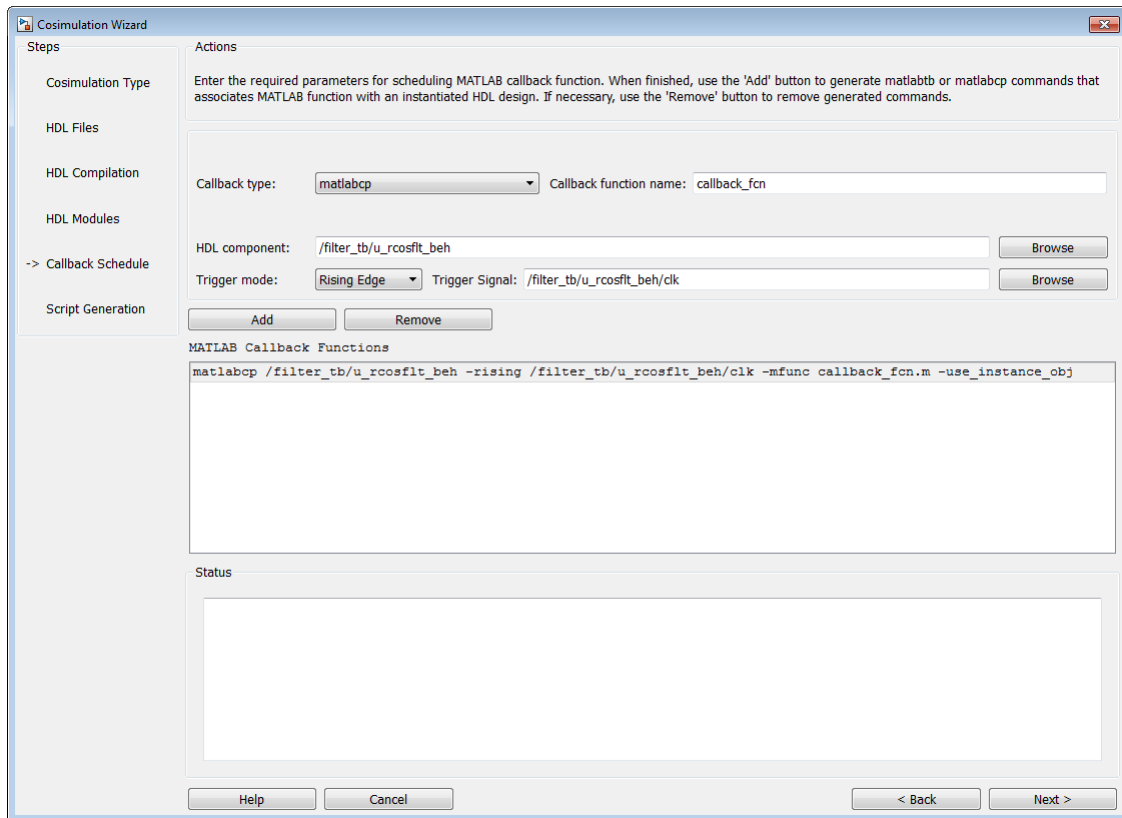

For more information on the callback parameters, see the reference page for `matlabcp`.

- 7 Click **Next** to proceed to the Generate Script page.

Tutorial: Generate Script

- 1 Leave **Launch HDL simulator after exiting this dialog** selected.

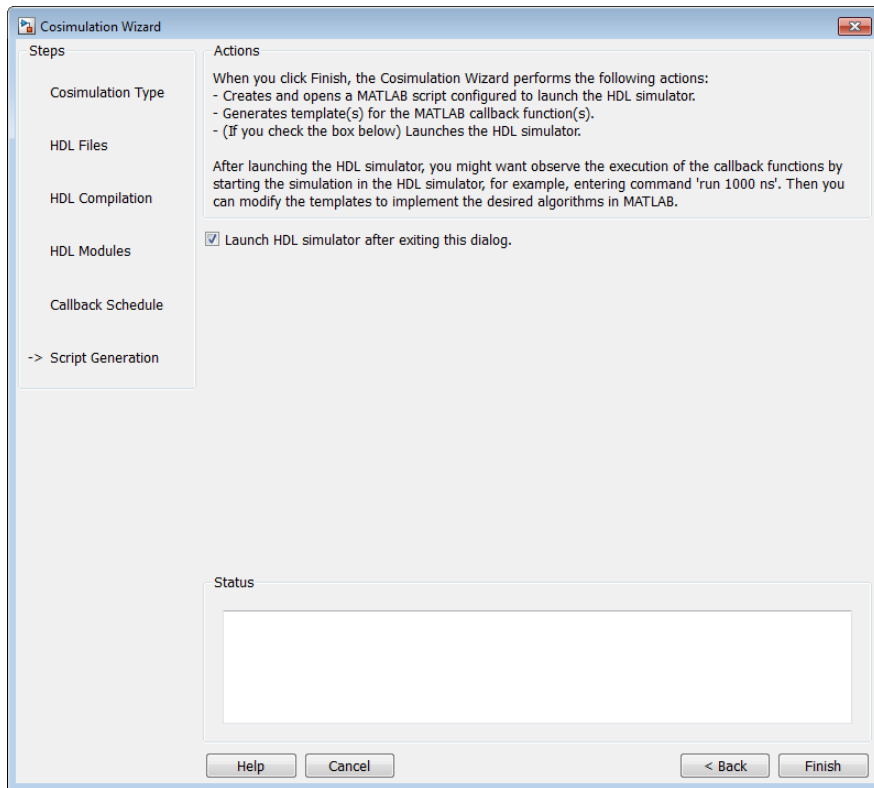

- 2 Click **Finish** to complete the Cosimulation Wizard session and generate scripts.

Tutorial: Customize Callback Function

After you click **Finish** in the Cosimulation Wizard, the application generates three HDL files in the current directory:

- `compile_hdl_design.m`: For recompiling the HDL design
- `launch_hdl_simulator.m`: To relaunch the MATLAB server and start the HDL simulator.
- `callback_fcn.m`: The MATLAB callback function

In addition to launching the HDL simulator, HDL Verifier software opens the MATLAB Editor and loads `callback_fcn.m` (partial image shown).

```

1 function callback_fcn(obj)
2
3 % MATLAB callback function template associated with HDL component(s):
4 % /rcosflt_rtl;
5 %
6 % File Name: callback_fcn.m
7 % Created: 02-Jun-2010 09:33:10
8 %
9 % Generated by EDA Cosimulation Assistant
10
11
12 % --- Initialize internal state(s) of callback function ---
13 if (strcmp(obj.simstatus,'Init'))
14     disp('Initializing states ...');
15     obj.userdata.State = 0;
16 end
17
18 % Display obj.tnow, which is the current HDL simulation time specified in
19 % seconds.
20 disp(['Callback function is executed at time ' num2str(obj.tnow)]);
21
22 % --- Read signal from HDL component ---
23 % Variable obj.portvalues.PortName contains the input value of port with
24 % name 'PortName' on the associated HDL component. The list of readable
25 % ports can be determined from the fields in struct obj.portinfo.out and
26 % obj.portinfo.inout.
27 %
28 % If obj.portvalues.PortName is multi-valued logic vector, you can convert
29 % it to decimal using function mvl2dec, e.g.,
30 %     decValue = mvl2dec(obj.portvalues.PortName, true);
31 %
32 % Optionally, you can also translate the port value into fixed-point
33 % object, e.g.
34 %     myfiobj = fi(decValue,1, 16, 4);
35

```

The generated template comprises four parts:

- Initialize internal state(s) of callback function
- Read signal from HDL component

- Write signal to HDL component
- Update internal state(s)

You modify this template to model a raised cosine filter in MATLAB following the instructions as shown in the following sections.

- “Tutorial: Define Internal States” on page 7-80
- “Tutorial: Read Signal from HDL Component” on page 7-81
- “Tutorial: Write Signal to HDL Component” on page 7-81
- “Tutorial: Update Internal States” on page 7-81

Note: You can find a completed modified callback function in `mycallback_solution.m`. This function resides in the directory you copied the tutorial files into. You can use this file to overwrite the one in your current directory. Name the file "callback_fcn.m", and change the function name to `callback_fcn`.

Tutorial: Define Internal States

Define two internal states: a 49-element vector to hold filter inputs and a vector of filter coefficients.

Edit `callback_fcn.m` so that the internal state section contains the following code:

```

12 % --- Initialize internal state(s) of callback function ---
13 if (strcmp(obj.simstatus,'Init'))
14     disp('Initializing states ...');
15     obj.userdata.State = zeros(1, 49);
16     obj.userdata.Coeff = [ ...
17         0,    18,    74,    165,    269,    350,    360,    254,    0,
18     ...
19     -405,   -925,  -1476, -1937, -2158, -1986, -1292,    0,  1889,
20     ...
21     4285,   7010,   9817, 12420, 14530, 15906, 16384, 15906, 14530,
22     ...
23     12420,   9817,   7010,  4285,  1889,    0, -1292, -1986, -2158,
24     ...
25     -1937, -1476,  -925,  -405,    0,   254,   360,   350,   269,
26     ...
27     165,    74,    18,    0]; % Filter coefficients, sfix16_En14
28 end

```

Tutorial: Read Signal from HDL Component

Read the filter input and convert it to a decimal number in MATLAB.

Edit `callback_fcn.m` so that the read signal section contains the following code:

```
25 % --- Read signal from HDL component ---
26 portValueDec = mvl2dec( ...
27     obj.portvalues.filter_in, ...
28     true);
29
```

Tutorial: Write Signal to HDL Component

The input "reset" signal controls the filter output. If reset is low, then the output is the product of previous inputs and filter coefficients. MATLAB converts the decimal result to a multivalued logic output of the HDL component.

Edit `callback_fcn.m` so that the write signal section contains the following code:

```
46
47 % --- Write signal to HDL component ---
48 if(obj.portvalues.reset == '1')
49     filter_out = 0;
50 else
51     filter_out = (obj.userdata.State * obj.userdata.Coef');
52 end
53 obj.portvalues.filter_out = dec2mvl(...
54     filter_out, 34);
55
```

Tutorial: Update Internal States

Use the filter input to update the internal 49-element state.

Edit `callback_fcn.m` so that the update internal states section contains the following code:

```

66
67 % --- Update internal state(s) ---
68 - disp(['Updated internal state: ' num2str(obj.userdata.State)]);
69 - if(obj.portvalues.reset == '1')
70 -     obj.userdata.State = zeros(1, 49);
71 - else
72 -     obj.userdata.State = [portValueDec obj.userdata.State(1:48)];
73 - end
74

```

Tutorial: Run Cosimulation and Verify HDL Design

Switch to the HDL simulator and enter the following command in the HDL simulator console:

```
run 200 ns
```

You see the following output displayed in the HDL simulator:

```

VSIM 2> run 200 ns
# At time          31, output of RTL module matches output of MATLAB.
# At time          41, output of RTL module matches output of MATLAB.
# At time          51, output of RTL module matches output of MATLAB.
# At time          61, output of RTL module matches output of MATLAB.
# At time          71, output of RTL module matches output of MATLAB.
# At time          81, output of RTL module matches output of MATLAB.
# At time          91, output of RTL module matches output of MATLAB.
# At time         101, output of RTL module matches output of MATLAB.
# At time         111, output of RTL module matches output of MATLAB.
# At time         121, output of RTL module matches output of MATLAB.
# At time         131, output of RTL module matches output of MATLAB.
# At time         141, output of RTL module matches output of MATLAB.
# At time         151, output of RTL module matches output of MATLAB.
# At time         161, output of RTL module matches output of MATLAB.
# At time         171, output of RTL module matches output of MATLAB.
# At time         181, output of RTL module matches output of MATLAB.
# At time         191, output of RTL module matches output of MATLAB.
VSIM 3>

```

These messages indicate that the output of the HDL component matches the behavioral output of the MATLAB component.

Verify Raised Cosine Filter Design Using Simulink

In this section...
“Simulink and Cosimulation Wizard Tutorial Overview” on page 7-84
“Tutorial: Set Up Tutorial Files (Simulink)” on page 7-85
“Tutorial: Launch Cosimulation Wizard (Simulink)” on page 7-85
“Tutorial: Configure the HDL Cosimulation Block with the Cosimulation Wizard” on page 7-85
“Tutorial: Create Test Bench to Verify HDL Design” on page 7-98
“Tutorial: Run Cosimulation and Verify HDL Design” on page 7-100

Simulink and Cosimulation Wizard Tutorial Overview

This tutorial guides you through the basic steps for setting up an HDL Verifier application that uses Simulink and the HDL simulator to verify an HDL design, using a Simulink model as the test bench. In this tutorial, you perform the steps to cosimulate Simulink and the HDL simulator to verify a simple raised cosine filter written in Verilog.

Note: This tutorial requires Simulink, the HDL Verifier software, and the ModelSim or Incisive HDL simulator. This tutorial assumes that you have read “Import HDL Code for HDL Cosimulation Block” on page 7-33.

In this tutorial, you perform the following steps:

- 1 “Tutorial: Set Up Tutorial Files (Simulink)” on page 7-85
- 2 “Tutorial: Launch Cosimulation Wizard (Simulink)” on page 7-85
- 3 “Tutorial: Configure the HDL Cosimulation Block with the Cosimulation Wizard” on page 7-85
- 4 “Tutorial: Create Test Bench to Verify HDL Design” on page 7-98
- 5 “Tutorial: Run Cosimulation and Verify HDL Design” on page 7-100

Tutorial: Set Up Tutorial Files (Simulink)

To help others access copies of the tutorial files, set up a folder for your own tutorial work by following these instructions:

- 1 Create a folder outside the scope of your MATLAB installation folder into which you can copy the tutorial files. The folder must be writable. This tutorial assumes that you create a folder named `MyTests`.
- 2 Copy all the files located in the following directory to the folder you created:

```
matlabroot\toolbox\edalink\foundation\hdlmlink\demo_src\tutorial
```

where *matlabroot* is the MATLAB root directory on your system.

- 3 You now have all the following files in your working directory, although, for this tutorial, you will need only two of them:
 - `filter_tb.v` (not used for this tutorial)
 - `mycallback_solution.m` (not used for this tutorial)
 - `rcosflt_beh.v` (not used for this tutorial)
 - `rcosflt_rtl.v`
 - `rcosflt_rtl.vhd`
 - `rcosflt_tb.mdl`

Tutorial: Launch Cosimulation Wizard (Simulink)

- 1 Start MATLAB.
- 2 Set the directory you created in “Tutorial: Set Up Tutorial Files (Simulink)” on page 7-85 as your current directory in MATLAB.
- 3 At the MATLAB command prompt, enter the following:

```
>>cosimWizard
```

The command launches the Cosimulation Wizard.

Tutorial: Configure the HDL Cosimulation Block with the Cosimulation Wizard

This tutorial leads you through the following wizard pages, designed to assist you in creating an HDL Cosimulation block.

- “Tutorial: Specify Cosimulation Type (Simulink)” on page 7-86
- “Tutorial: Select HDL Files (Simulink)” on page 7-87
- “Tutorial: Specify HDL Compilation Commands (Simulink)” on page 7-88
- “Tutorial: Select Simulation Options for Cosimulation (Simulink)” on page 7-90
- “Tutorial: Specify Port Types” on page 7-92
- “Tutorial: Specify Output Port Details” on page 7-93
- “Tutorial: Set Clock and Reset Details” on page 7-94
- “Tutorial: Confirm Start Time Alignment” on page 7-95
- “Tutorial: Generate Block” on page 7-97

Tutorial: Specify Cosimulation Type (Simulink)

In the Cosimulation Type page, perform the following steps:

- 1** Leave **HDL cosimulation with** option set to **Simulink**.
- 2** If you are using ModelSim, leave **HDL Simulator** option as **ModelSim**.

If you are using Incisive, change **HDL Simulator** option to **Incisive**.
- 3** Leave the default option **Use HDL simulator executables on the system path** option if the HDL simulator executables appear on your system path.

If these executable do not appear on the path, specify the HDL simulator path as described in “Cosimulation Type—Simulink Block” on page 7-33.

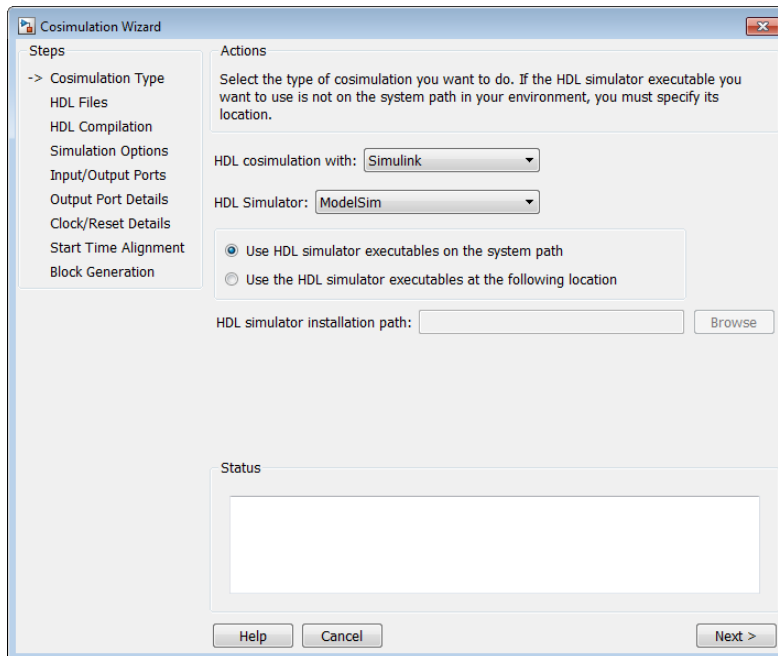

4 Click **Next** to proceed to the HDL Files page.

Tutorial: Select HDL Files (Simulink)

In the HDL Files page, perform the following steps:

- 1** Add HDL files to file list.
 - a** Click **Add** and browse to the directory you created in “Tutorial: Set Up Tutorial Files (Simulink)” on page 7-85.
 - b** For Verilog, select `rcosflt_rtl.v`. For VHDL[®], select `rcosflt_rtl.vhd`.
 - c** Review the file in the file list with the file type identified as you expected.

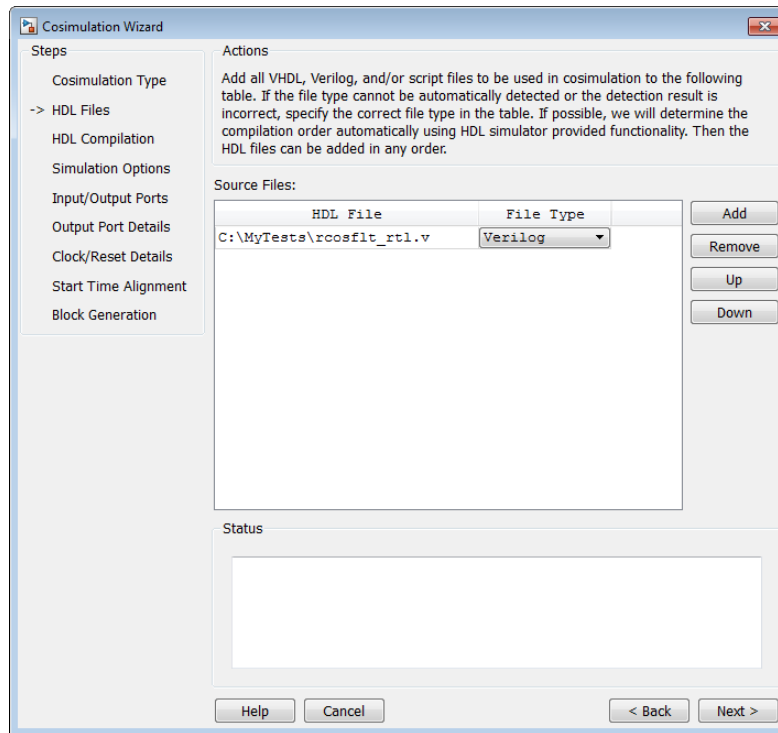

2 Click **Next** to proceed to the HDL Compilation page.

Tutorial: Specify HDL Compilation Commands (Simulink)

The Cosimulation Wizard lists the default commands in the Compilation Commands window. You do not need to change these commands for this tutorial.

When you run the Cosimulation Wizard with your own code, you may add or change the compilation commands in this window. For example, you can add the `-vlog01compat` switch.

ModelSim users: The HDL Compilation pane will look similar to the one in this figure:

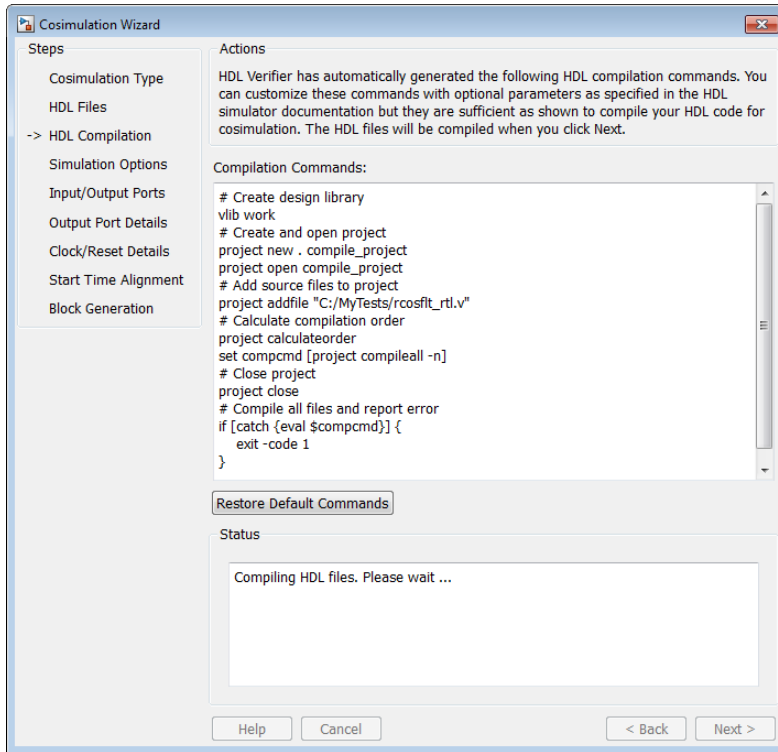

Incisive users: Your HDL Compilation pane will look similar to the one in the following figure.

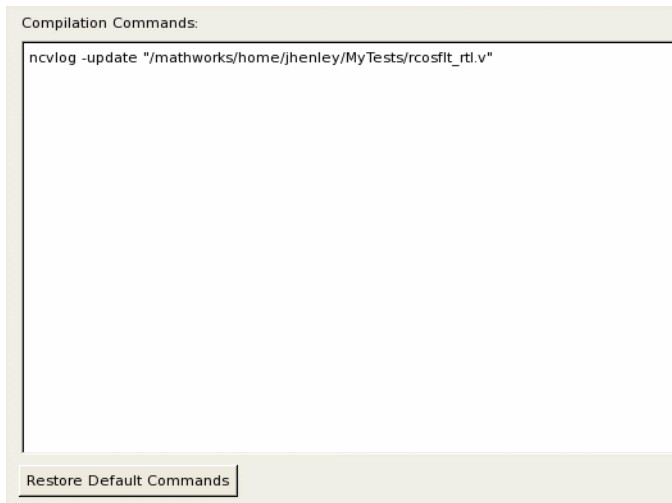

Click **Next** to proceed to the HDL Modules pane.

The MATLAB console displays the compilation log. If an error occurs during compilation, that error appears in the Status area. Change whatever settings you can to remove the error before proceeding to the next step.

Tutorial: Select Simulation Options for Cosimulation (Simulink)

In the Simulation Options pane, perform the following steps:

- 1 Specify the name of HDL module/entity for cosimulation.

From the drop-down list, select `rcosflt_rtl`. This module is the Verilog/VHDL module you use for cosimulation.

If you do not see `rcosflt_rtl` in the drop-down list, you can enter the file name manually.

- 2 ModelSim users: In the Simulation options field, remove the `-novopt` option so that ModelSim can optimize the HDL design.
- 3 For **Connection method**, select **Shared Memory** if your firewall policy does not allow TCP/IP socket communication.

The simulation options now look similar to those shown in the next figure.

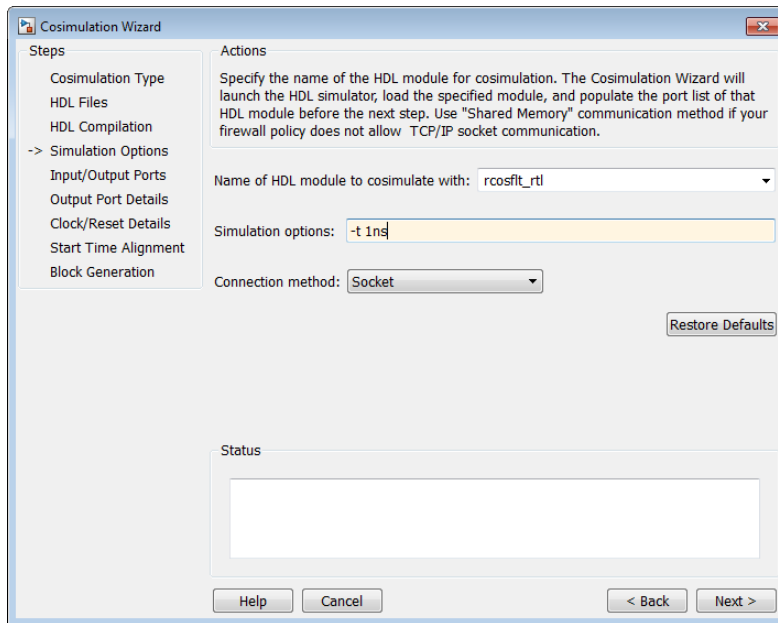

Incisive users: Your HDL Module options look similar to the following figure

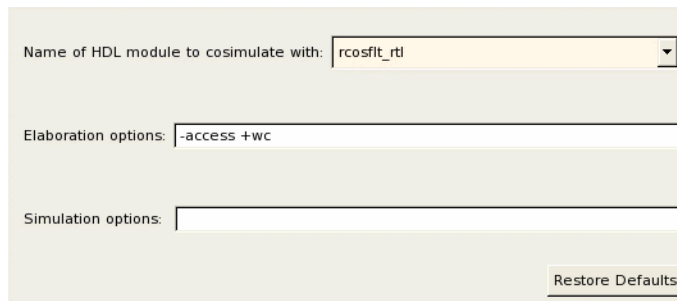

- 4 Click **Next** to proceed to the Simulink Ports pane.

The Cosimulation Wizard launches the HDL simulator in the background console using the specified HDL module and simulation options. After the wizard launches the HDL simulator, the wizard populates the input and output ports on the Verilog/VHDL model `rcosflt_rtl` and displays them in the next step.

Tutorial: Specify Port Types

In this step, the Cosimulation Wizard displays two tables containing the input and output ports of `rcosflt_rtl`, respectively.

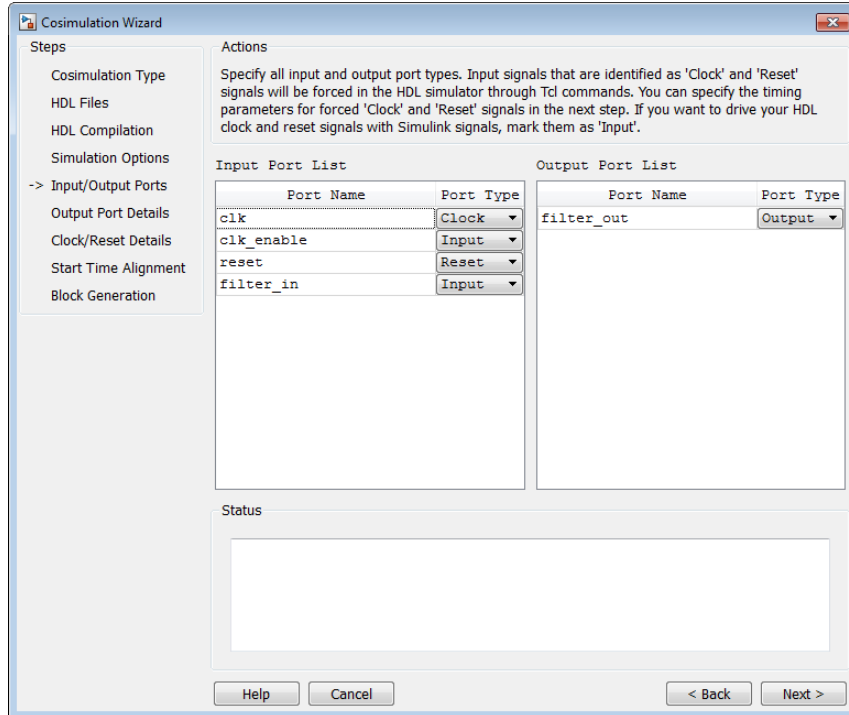

The Cosimulation Wizard attempts to identify the port type for each port. If the wizard incorrectly identifies a port, you can change the port type using these tables.

- For input ports, you can select from **Clock**, **Reset**, **Input**, or **Unused**. HDL Verifier connects only the input ports marked **Input** to Simulink during cosimulation.
- HDL Verifier connects output ports marked **Output** with Simulink during cosimulation. The wizard and Simulink ignore those output ports marked **Unused** during cosimulation.
- You can change the parameters for signals identified as **Clock** and **Reset** at a later step.

Accept the default port types and click **Next** to proceed to the **Output Port Details** page.

Tutorial: Specify Output Port Details

In the Output Port Details page, perform the following steps:

- 1 Set the sample time of `filter_out` to `-1` to inherit via back propagation.
- 2 You can see from the Verilog code that the Cosimulation Wizard represents the output in a `S34,29` format. Change the following fields:
 - Data Type to **Fixedpoint**
 - Sign to **Signed**
 - Fraction Length to **29**

. Your results now look similar to the following image.

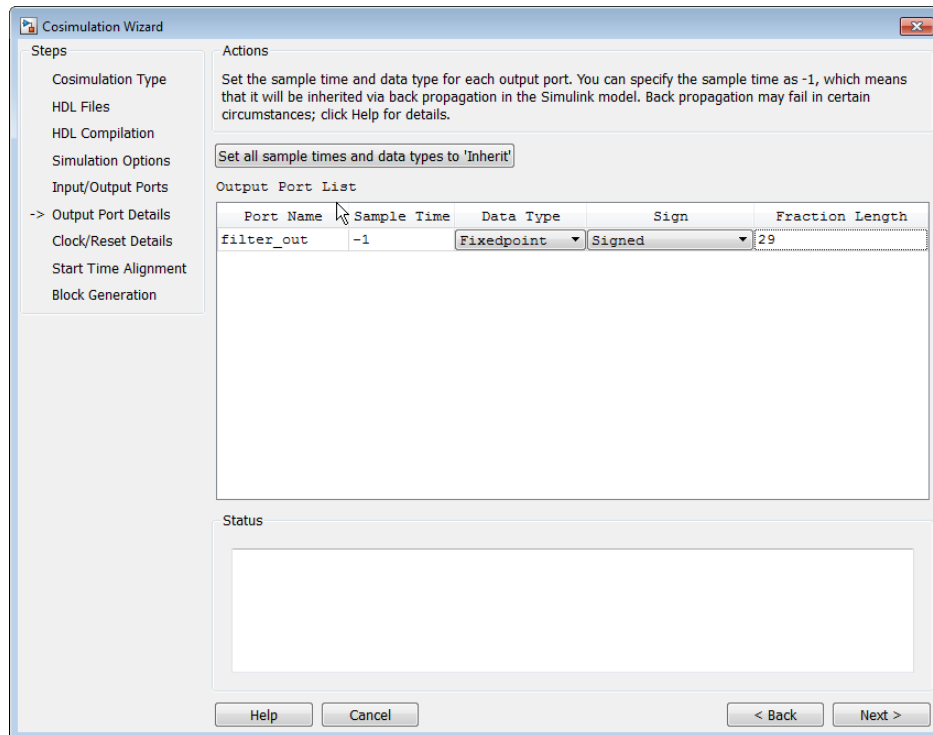

- 3 Click **Next** to proceed to the Clock/Reset Details page.

Tutorial: Set Clock and Reset Details

For this tutorial, set the clock **Period (ns)** to 20. From the Verilog code, you know that the reset is synchronous and the active value is 1. You can reset the entire HDL design at time 1 ns, triggered by the rising edge of the clock. Use a duration of 15 ns for the reset signal.

In the Clock/Reset Details page, perform the following steps:

- 1 Set clock period to 20.
- 2 Leave or set active edge to **Rising**.
- 3 Leave or set reset initial value to 1.
- 4 Set reset signal duration to 15.

Your clock and reset are now the same as those same signals shown in the following figure.

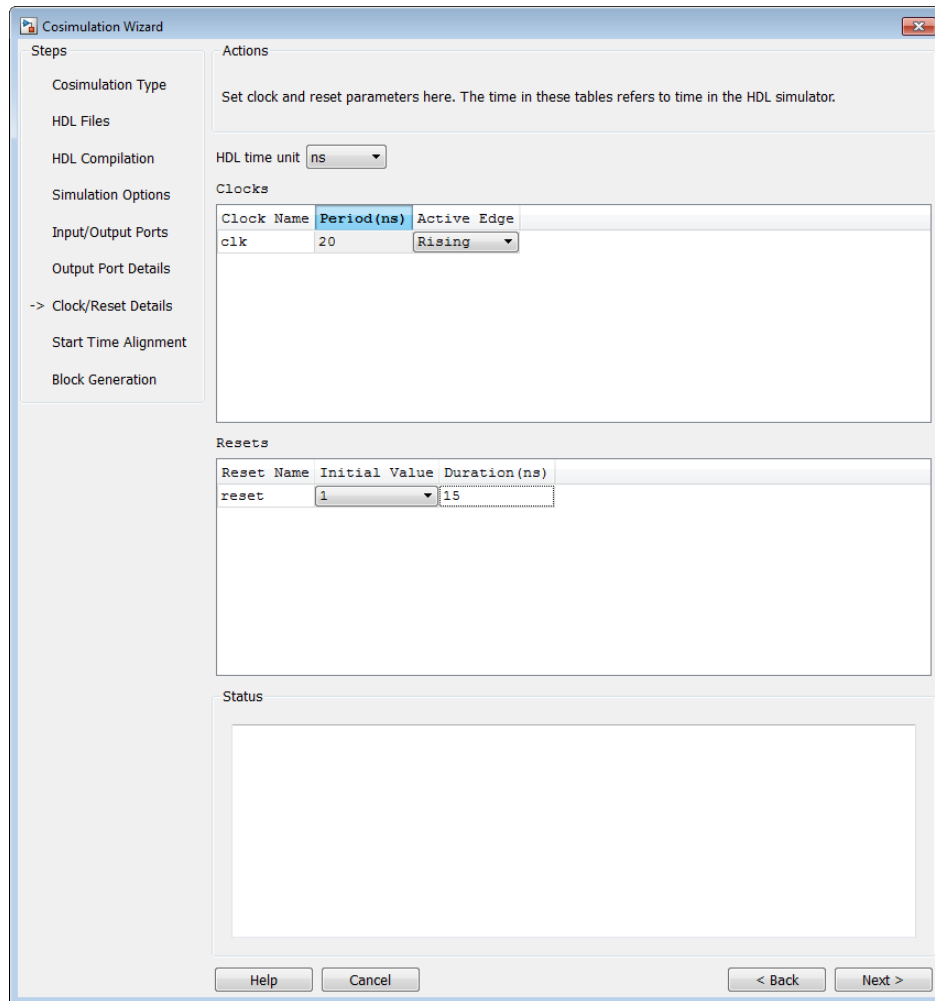

- 5 Click **Next** to proceed to the Start Time Alignment page.

Tutorial: Confirm Start Time Alignment

The Start Time Alignment page displays a plot for the waveforms of clock and reset signals. The Cosimulation Wizard shows the HDL time to start cosimulation with a red line. The start time is also the time at which the Simulink gets the first input sample from the HDL simulator.

1 Set or confirm Start Time Alignment

The active edge of our clock is a rising edge. Thus, at time 20 ns in the HDL simulator, the registered output of the raised cosine filter is stable. No race condition exists, and the default HDL time to start cosimulation (20 ns) is what we want for this simulation. You do not need to make any changes to the start time.

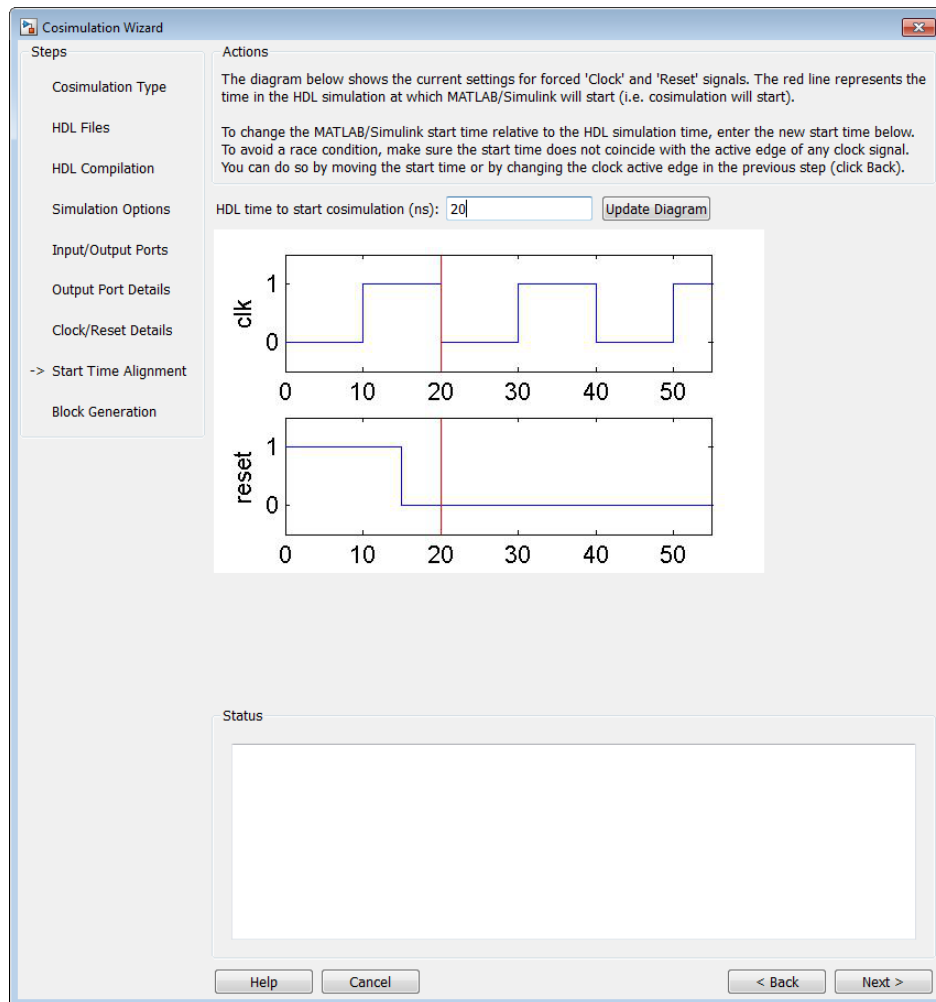

2 Click **Next** to proceed to Block Generation.

Tutorial: Generate Block

Before you generate the HDL `Cosimulation` block, you have the option to determine the timescale before you finish the Cosimulation Wizard. Alternately, you can instruct HDL Verifier to calculate a timescale later. Timescale calculation by the verification software occurs after you connect all the input/output ports of the generated HDL `Cosimulation` block and start simulation.

- 1 Leave **Automatically determine timescale at start of simulation** selected (default). Later, you will have the opportunity to view the calculated timescale and change that value before you begin simulation.

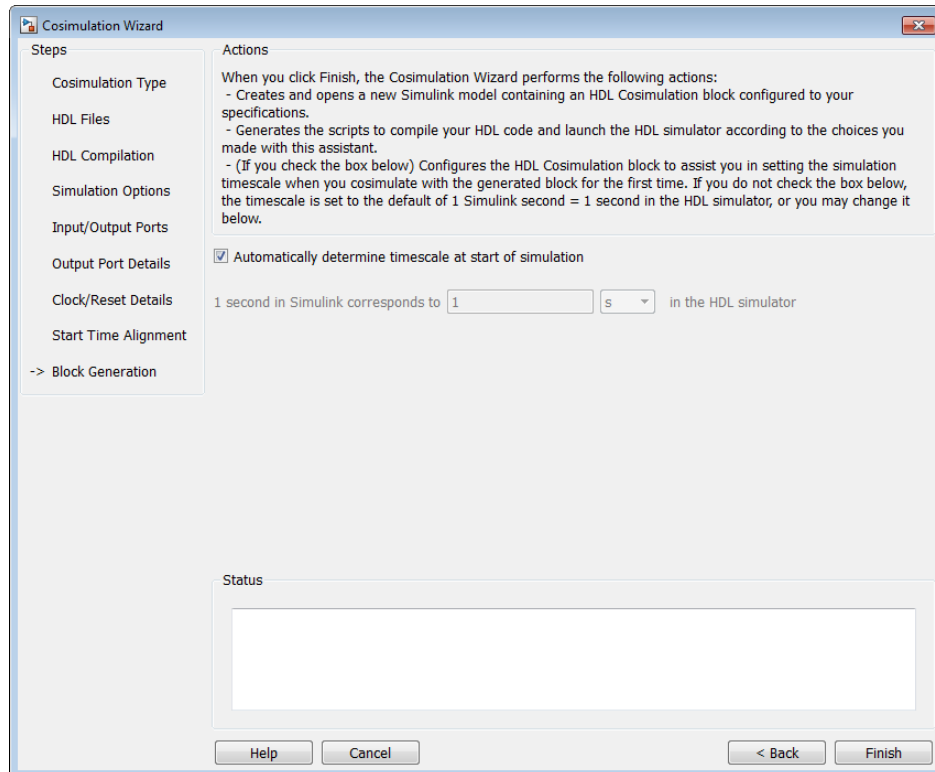

- 2 Click **Finish** to complete the Cosimulation Wizard session.

Tutorial: Create Test Bench to Verify HDL Design

For this tutorial, you do not actually create the test bench. Instead, you can find the finished model (`rcosflt_tb.mdl`) in the directory you created in “Tutorial: Set Up Tutorial Files (Simulink)” on page 7-85.

- 1 After you click **Finish** in the Cosimulation Wizard, Simulink creates a model and populates it with the following items:
 - An HDL Cosimulation block
 - A block to recompile the HDL design (contains a link to a script that is launched by double-clicking the block)
 - A block to launch the HDL simulator (contains a link to a script that is launched by double-clicking the block)

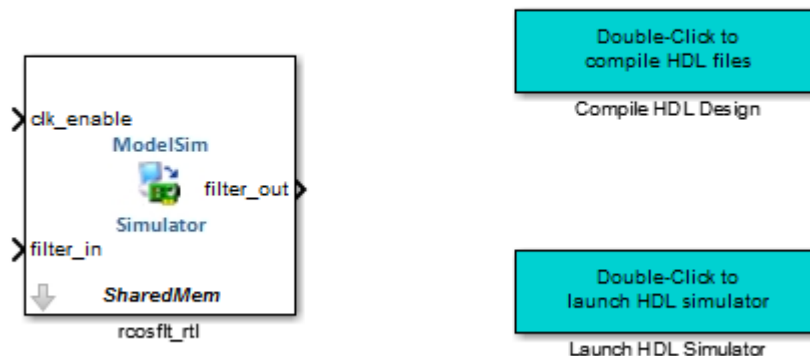

Leave the model for the moment and proceed to the next step.

- 2 Open the file `rcosflt_tb`, located in the directory you created in “Tutorial: Set Up Tutorial Files (Simulink)” on page 7-85.

This file contains a model of a Simulink test bench. You will use this test bench to verify the HDL design for which you just generated a corresponding HDL Cosimulation block.

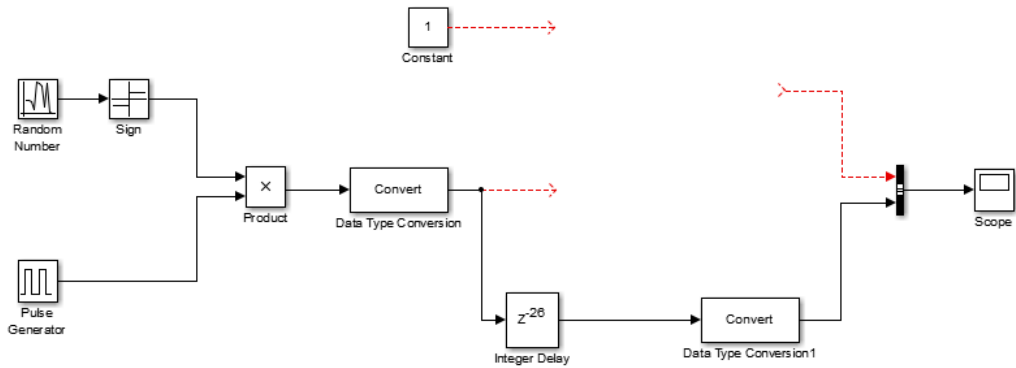

3 Add the HDL Cosimulation block to the test bench model as follows:

- a Copy the HDL Cosimulation block from the newly generated model to this test bench model.
- b Place the block so that the constant and convert blocks line up as inputs to the HDL Cosimulation block and the bus lines up as output.
- c Connect the blocks in the test bench to the HDL Cosimulation block.

4 Copy the script blocks to the area below the test bench. Your model now looks similar to that in the following figure.

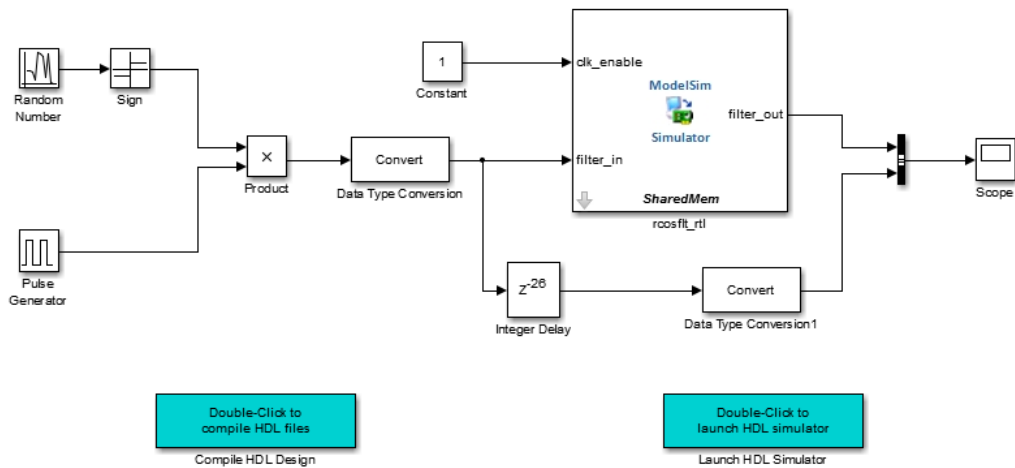

5 Save the model.

Tutorial: Run Cosimulation and Verify HDL Design

- 1 Launch the HDL simulator by double-clicking the block labeled **Launch HDL Simulator**.
- 2 When the HDL simulator is ready, return to Simulink and start the simulation.
- 3 Determine timescale.

Recall that you selected **Automatically determine timescale at start of simulation** option on the last page of the Cosimulation Wizard. Because you did so, HDL Verifier launches the Timescale Details GUI instead of starting the simulation.

Both the HDL simulator and Simulink sample the `filter_in` and `filter_out` ports at 1 second. However, their sample time in the HDL simulator should be the same as the clock period (2 ns).

- Change the Simulink sample time of `/rcosflt_rtl/filter_in` to 1 (seconds), and press **Enter**. The wizard then updates the table. The following figure shows the new timescale: 1 second in Simulink corresponds to 2e-008 s in the HDL simulator.

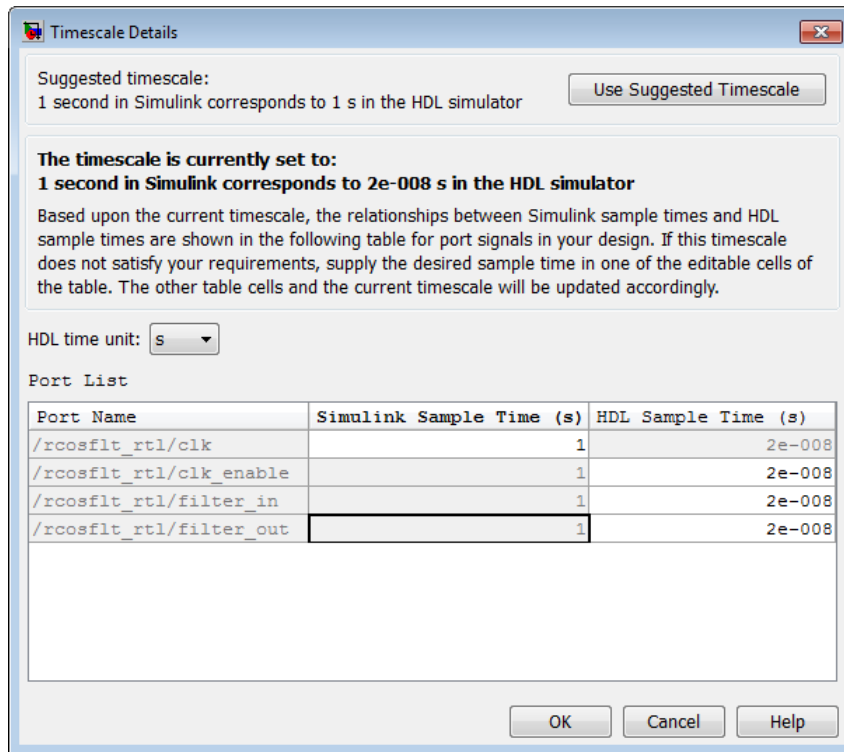

- b** Click **OK** to exit Timescale Details.
- 4** Restart simulation.
- 5** Verify the result from the scope in the test bench model. The scope displays both the delayed version of input to raised cosine filter and that filter's output. If you sample the output of this filter output directly, no inter-symbol-interference occurs

Help Button

In this section...

“Cosimulation Type” on page 7-103

“HDL Files” on page 7-105

“HDL Compilation” on page 7-106

“HDL Modules” on page 7-107

Cosimulation Type

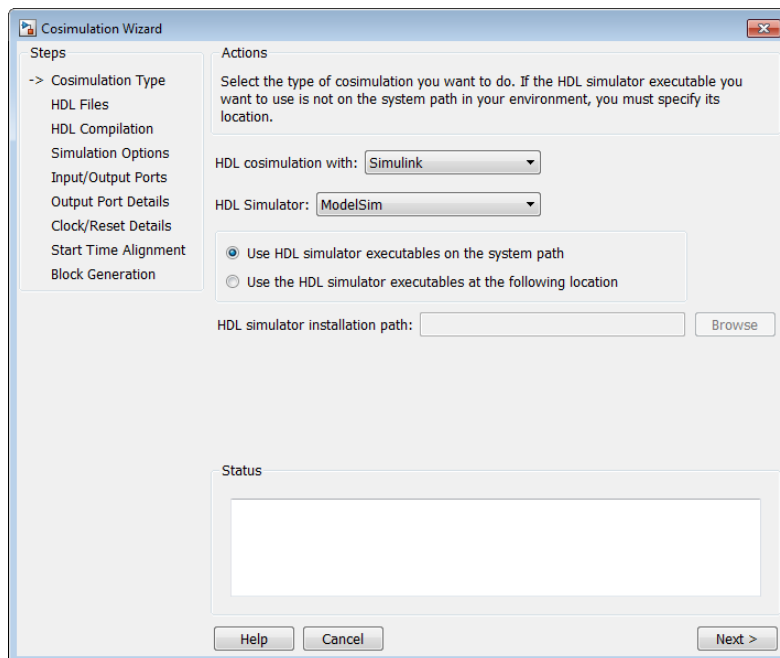

- 1 Select your HDL Cosimulation workflow in the field **HDL cosimulation with:** Simulink, MATLAB, or MATLAB System Object. This setting instructs the wizard to create a block, function template, or System object, respectively.
- 2 Select the HDL simulator you want to use: ModelSim or Incisive.

- 3 Select **Use HDL simulator executables on the system path** if that is where the files are located. The Cosimulation Wizard assumes by default that they are on the system path.

If the HDL simulator executables are *not* on the system path, select **Use the following HDL simulator executables at the following location** and specify the folder location in the text box below.

If you click **Next** and the Cosimulation Wizard does not find the executables, the following occurs:

- You are returned to this dialog and the Cosimulation Wizard displays an error in the status pane.
- The Cosimulation Wizard switches the option to **Use the following HDL simulator executables at the following location**.
- The Cosimulation Wizard makes the HDL simulation path field editable.

You must enter a valid path to the HDL simulator executables before you are allowed to continue.

Next Steps

- For an HDL cosimulation block, start at “Cosimulation Type—Simulink Block” on page 7-33.
- For an HDL cosimulation function, start at “Cosimulation Type—MATLAB Function” on page 7-6.
- For an HDL cosimulation System object, start at “Cosimulation Type—MATLAB System Object” on page 7-17.

HDL Files

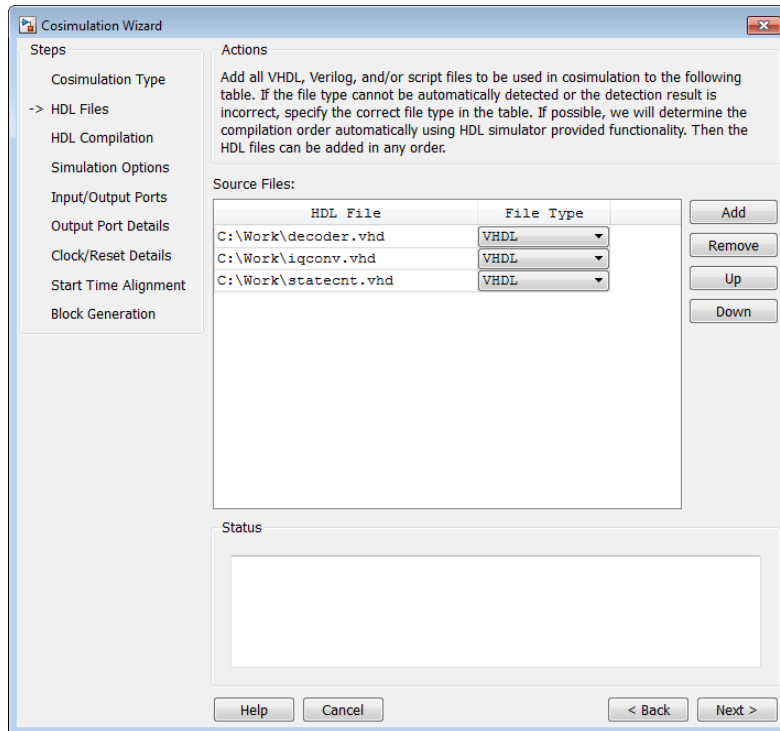

In the **HDL Files** pane, specify the files to be used in creating the function or block.

- 1 Click **Add** to select one or more file names.

The Cosimulation Wizard attempts to determine the file type of each file and display the type in the **File List** next to the file name. If the Cosimulation Wizard cannot determine the type or displays the wrong type, you can change the type directly in the **File Type** column.

If you are using ModelSim, you will see compilation scripts listed as .do files (ModelSim macro file). If you are using Incisive, you will see compilation scripts listed as system scripts.

- 2 Remove files by first highlighting the file name in the **File List**, then clicking **Remove Selected File**.

Next Steps

- For an HDL cosimulation block, start at “HDL Files—Simulink Block” on page 7-35.
- For an HDL cosimulation function, start at “HDL Files—MATLAB Function” on page 7-8.
- For an HDL cosimulation System object, start at “HDL Files—MATLAB System Object” on page 7-20.

HDL Compilation

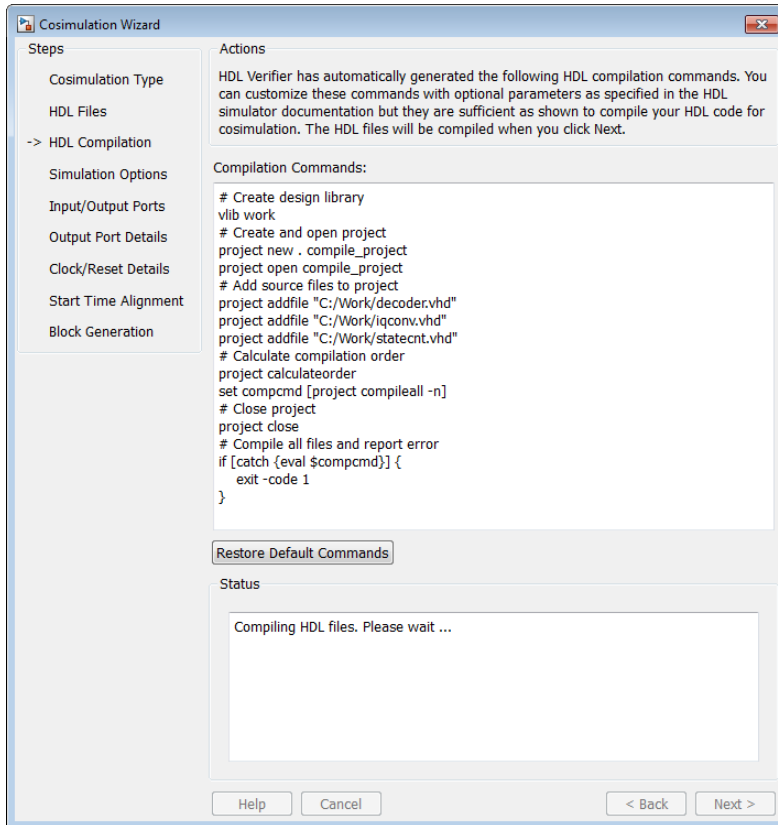

In the **HDL Compilation** pane, you can review the generated HDL compilation commands. You may override and/or customize those commands, if you wish. If you

included compilation scripts instead of HDL files, this pane will show you the command to run those scripts.

- 1 Enter any changes to the commands in the **Compilation Commands** box.

Note: Do not include system shell commands; for example:

```
set file = a.vhd vcom $file
```

When control returns to the Cosimulation Wizard from executing the command, the variable no longer holds the value that was set. If you do try to include this type of command, you will see an error in the **Status** panel.

- 2 Click **Restore default commands** to go back to the generated HDL compilation commands. You are asked to confirm that you want to discard any changes.

Next Steps

- For an HDL cosimulation block, start at “HDL Compilation—Simulink Block” on page 7-37.
- For an HDL cosimulation function, start at “HDL Compilation—MATLAB Function” on page 7-9.
- For an HDL cosimulation System object, start at “HDL Compilation—MATLAB System Object” on page 7-21.

HDL Modules

HDL Modules—Simulink Block

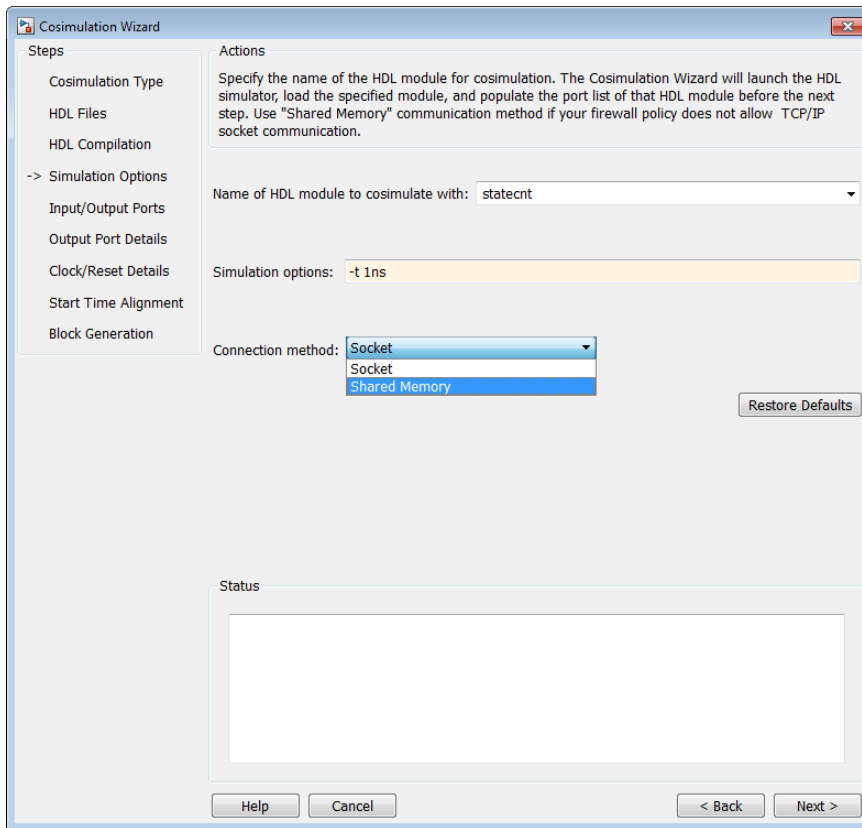

In the **HDL Modules** pane, provide the name of the HDL module to be used in cosimulation.

- 1 Enter the name of the module at **Name of HDL module to cosimulate with**.
- 2 Specify additional simulation options at **Simulation options**. For example, in the previous image, the options shown are:
 - HDL simulator resolution
 - Turn off optimizations that remove signals from the simulation view

Click **Restore Defaults** to change the options back to the default.

- 3 When you proceed to the next step, the application performs the following actions in a command window:

- Starts the HDL simulator.
- Loads the HDL module in the HDL simulator.
- Starts the HDL server, and waits to receive notice that the server has started.
- Connects with the HDL server to get the port information.
- Disconnects and shuts down the HDL server.

Next Steps

- For an HDL cosimulation block, start at “Simulation Options—Simulink Block” on page 7-38.
- For an HDL cosimulation function, start at “HDL Modules—MATLAB Function” on page 7-10.
- For an HDL cosimulation System object, start at “Simulation Options—MATLAB System Object” on page 7-23.

HDL Cosimulation Reference

- “Startup for HDL Cosimulation” on page 8-2
- “Cross-Network Cosimulation” on page 8-22
- “Test Bench and Component Function Writing” on page 8-28
- “Simulation Speed Improvement Tips” on page 8-37
- “Race Conditions in HDL Simulators” on page 8-46
- “Data Type Conversions” on page 8-49
- “Simulation Timescales” on page 8-57
- “Clock, Reset, and Enable Signals” on page 8-70
- “TCP/IP Socket Ports” on page 8-77

Startup for HDL Cosimulation

In this section...

- “Machine Configuration Requirements” on page 8-2
- “HDL Simulator Startup” on page 8-4
- “HDL Verifier Libraries” on page 8-10
- “Setup Diagnostics and Customization” on page 8-15

Machine Configuration Requirements

- “Valid Configurations For Using the HDL Verifier Software with MATLAB Applications” on page 8-2
- “Valid Configurations For Using the HDL Verifier Software with Simulink Software” on page 8-3

Valid Configurations For Using the HDL Verifier Software with MATLAB Applications

The following list provides samples of valid configurations for using the HDL simulator and the HDL Verifier software with MATLAB software. The scenarios apply whether the HDL simulator is running on the same or different computing system as the MATLAB software. In a network configuration, you use an Internet address in addition to a TCP/IP socket port to identify the servers in an application environment.

- An HDL simulator session connected to a MATLAB function `f00` through a single instance of the MATLAB server
- An HDL simulator session connected to multiple MATLAB functions (for example, `f00` and `bar`) through a single instance of the MATLAB server
- An HDL simulator session connected to a MATLAB function `f00` through multiple instances of the MATLAB server (each running within the scope of a unique MATLAB session)
- Multiple HDL simulator sessions each connected to a MATLAB function `f00` through multiple instances of the MATLAB server (each running within the scope of a unique MATLAB session)
- Multiple HDL simulator sessions each connected to a different MATLAB function (for example, `f00` and `bar`) through the same instance of the MATLAB server
- Multiple HDL simulator sessions each connected to MATLAB function `f00` through a single instance of the MATLAB server

Although multiple HDL simulator sessions can connect to the same MATLAB function in the same instance of the MATLAB server, as this configuration scenario suggests, such connections are not recommended. If the MATLAB function maintains state (for example, maintains global or persistent variables), you may experience unexpected results because the MATLAB function does not distinguish between callers when handling input and output data. If you must apply this configuration scenario, consider deriving unique instances of the MATLAB function to handle requests for each HDL entity.

Notes

- Shared memory communication is an option for configurations that require only one communication link on a single computing system.
 - TCP/IP socket communication is required for configurations that use multiple communication links on one or more computing systems. Unique TCP/IP socket ports distinguish the communication links.
 - In any configuration, an instance of MATLAB can run only one instance of the HDL Verifier MATLAB server (`hdldaemon`) at a time.
 - In a TCP/IP configuration, the MATLAB server can handle multiple client connections to one or more HDL simulator sessions.
-

Valid Configurations For Using the HDL Verifier Software with Simulink Software

The following list provides samples of valid configurations for using the HDL simulator and the HDL Verifier software with Simulink software. The scenarios apply whether the HDL simulator is running on the same or different computing system as the MATLAB or Simulink products. In a network configuration, you use an internet address in addition to a TCP/IP socket port to identify the servers in an application environment.

- An `HDL Cosimulation` block in a Simulink model connected to a single HDL simulator session
- Multiple `HDL Cosimulation` blocks in a Simulink model connected to the same HDL simulator session
- An `HDL Cosimulation` block in a Simulink model connected to multiple HDL simulator sessions

- Multiple HDL `Cosimulation` blocks in a Simulink model connected to different HDL simulator sessions

Notes

- HDL `Cosimulation` blocks in a Simulink model can connect to the same or different HDL simulator sessions.
 - TCP/IP socket communication is required for configurations that use multiple communication links on one or more computing systems. Unique TCP/IP socket ports distinguish the communication links.
 - Shared memory communication is an option for configurations that require only one communication link on a single computing system.
-

HDL Simulator Startup

- “Starting the HDL Simulator from MATLAB” on page 8-4
- “Starting the HDL Simulator from a Shell” on page 8-8

Starting the HDL Simulator from MATLAB

- “Overview” on page 8-4
- “Starting the ModelSim Simulator from MATLAB” on page 8-6
- “Starting the Cadence Incisive Simulator from MATLAB” on page 8-7

Overview

For each supported HDL simulator, HDL Verifier has a unique command to launch the HDL simulator from within MATLAB. Each command contains a set of customized property value pairs for specifying the HDL Verifier library to use, the design to load, the type of communication connection, and so on.

Note: If you plan to use the Cosimulation Wizard, you do not need to start the HDL simulator separately.

The HDL simulator launch commands are as follows:

HDL Simulator	HDL Verifier Launch Command
Cadence Incisive	<code>nclaunch</code>
Mentor Graphics ModelSim	<code>vsim</code>

- You issue the launch command directly from MATLAB and provide the HDL Verifier library information and other required parameters (see “HDL Verifier Libraries” on page 8-10). No special setup is required. This function starts and configures the HDL simulator for use with the HDL Verifier software. By default, the function starts the first version of the simulator executable that it finds on the system path (defined by the `path` variable), using a temporary file that is overwritten each time the HDL simulator starts.
- You can customize the startup file and communication mode to be used between MATLAB or Simulink and the HDL simulator by specifying the call to the HDL simulator launch command with property name/property value pairs. Refer to the `nclaunch` or `vsim` reference documentation for specific information regarding the property name/property value pairs.
- If you want to start a different version of the simulator executable than the first one found on the system path, use the `setenv` and `getenv` MATLAB functions to set and get the environment of any sub-shells spawned by `UNIX()`, `DOS()`, or `system()`.
- When you specify a communication mode using any of the HDL Verifier HDL simulator launch commands, the function applies the specified communication mode to all MATLAB or Simulink/HDL simulator sessions.

Resources

- “Starting the ModelSim Simulator from MATLAB” on page 8-6, and “Starting the Cadence Incisive Simulator from MATLAB” on page 8-7 for examples of using these HDL Verifier HDL simulator launch commands with various property/name value pairs and other parameters.
-
- “Linking with MATLAB and the HDL Simulator” for more information on how HDL Verifier links the HDL simulator with MATLAB.
- “Verify HDL Model with MATLAB Test Bench” on page 1-37 for a full cosimulation example that demonstrates starting the HDL simulator from MATLAB.

Diagnostic and Customization Setup Script for use with Incisive and ModelSim If you would like some assistance in setting up your environment for use with HDL Verifier, you can diagnose your setup (remove or fix omissions and errors) and also customize your setup for future invocations of `nclaunch` or `vsim` by following the process in “Setup Diagnostics and Customization” on page 8-15.

Starting the ModelSim Simulator from MATLAB

To start the HDL simulator from MATLAB, enter `vsim` at the MATLAB command prompt:

```
>> vsim('PropertyName', 'PropertyValue'...)
```

The following example changes the folder location to `VHDLproj` and then calls the function `vsim`. Because the command line omits the `'vsimdir'` and `'startupfile'` properties, `vsim` creates a temporary DO file. The `'tclstart'` property specifies Tcl commands that load and initialize the HDL simulator for test bench instance `modsimrand`.

```
cd VHDLproj
vsim('tclstart',...
     'vsimmatlab modsimrand; matlabtb modsimrand 10 ns -socket 4449')
```

The following example changes the folder location to `VHDLproj` and then calls the function `vsim`. Because the function call omits the `'vsimdir'` and `'startupfile'` properties, `vsim` creates a temporary DO file. The `'tclstart'` property specifies a Tcl command that loads the VHDL entity `parse` in library `work` for cosimulation between `vsim` and Simulink. The `'socketsimulink'` property specifies TCP/IP socket communication on the same computer, using socket port 4449.

```
cd VHDLproj
vsim('tclstart', 'vsimulink work.parse', 'socketsimulink', '4449')
```

The following example has the HDL compilation and simulation commands run when you start the ModelSim software from MATLAB.

```
vsim('tclstart', ...
     {'\lib work', '\vlog +acc clocked_inverter.v hdl_top.v', 'vsim +acc hdl_top' });
```

This next example loads the HDL simulation just as in the previous example but it also loads in the Link to Simulink library, uses socket number 5678 to communicate with cosimulation blocks in Simulink models, and uses an HDL time precision of 10 ps.

```
vsim('tclstart', ...
```

```
{'vlib work', 'vlog -novopt clocked_inverter.v hdl_top.v', ...
'vsimulink hdl_top -socket 5678 -t 10ps'});
```

Or

```
vsim('tclstart', ...
{'vlib work', 'vlog -novopt clocked_inverter.v hdl_top.v', ...
'vsimulink hdl_top -t 10ps'}, ...
'socketsimulink', 5678);
```

Starting the Cadence Incisive Simulator from MATLAB

To start the HDL simulator from MATLAB, enter `nclaunch` at the MATLAB command prompt:

```
>> nclaunch('PropertyName', 'PropertyValue'...)
```

The following example changes the folder location to `VHDLproj` and then calls the function `nclaunch`. Because the command line omits the `'hdlsimdir'` and `'startupfile'` properties, `nclaunch` creates a temporary file. The `'tclstart'` property specifies Tcl commands that load and initialize the HDL simulator for test bench instance `modsimrand`.

```
cd VHDLproj
nclaunch('tclstart',...
'hdlsimmatlab modsimrand; matlabtb modsimrand 10 ns -socket 4449')
```

The following example changes the folder location to `VHDLproj` and then calls the function `nclaunch`. Because the function call omits the `'hdlsimdir'` and `'startupfile'` properties, `nclaunch` creates a temporary file. The `'tclstart'` property specifies a Tcl command that loads the VHDL entity `parse` in library `work` for cosimulation between `nclaunch` and Simulink. The `'socketsimulink'` property specifies TCP/IP socket communication on the same computer, using socket port 4449.

```
cd VHDLproj
nclaunch('tclstart', 'hdlsimulink work.parse', 'socketsimulink', '4449')
```

Another option is to bring `ncsim` up in the terminal instead of launching the GUI, thereby allowing you to interact with the simulation. This next example lists the steps for you to do this:

- 1 Start `hdldaemon` in MATLAB.
- 2 Start an `xterm` from MATLAB in the background (key point).
- 3 Run `ncsim` in the `xterm` shell having it call back to the `hdlserver` to run your `matlabcp` function as usual.

- 4 Have the `matlabcp` function touch a file to signal completion while an M script polls for completion.

The MATLAB script can then change test parameters and run more tests.

Note: The `nclaunch` command requires the use of property name/property value pairs. You get an error if you try to use the function without them.

Starting the HDL Simulator from a Shell

- “Starting the ModelSim Software from a Shell” on page 8-8
- “Starting the Cadence Incisive HDL Simulator from a Shell” on page 8-9

Starting the ModelSim Software from a Shell

To start the HDL simulator from a shell and include the HDL Verifier libraries, you need to first run the configuration script. See “Setup Diagnostics and Customization” on page 8-15.

After you have the configuration files, you can start the ModelSim software from the shell by typing:

```
% vsim design_name -f matlabconfigfile
```

`matlabconfigfile` should be the name of the MATLAB configuration file you created with `syscheckmq` (Linux/UNIX[®]) or that you created yourself using our template (Windows). If you are connecting to Simulink, this should be the name of the Simulink configuration file. You must also specify the path to the configuration file even if it resides in the same folder as `vsim.exe`. Use `design_name` if you want to also start the simulation.

The configuration file mainly defines the `-foreign` option to `vsim` which in turn loads the HDL Verifier shared library and specifies its entry point.

You can also specify any other existing configuration files you may also be using with this call.

If you are performing this step manually, the following use of `-foreign` with `vsim` loads the HDL Verifier client shared library and specifies its entry point:

```
% vsim design_name -foreign matlabclient /path/library
```

where `path` is the path to this particular HDL Verifier library. See “HDL Verifier Libraries” on page 8-10 to find the applicable library name for your machine. Use `design_name` if you want to also start the simulation.

Note: You can also issue this exact same command from inside the HDL simulator.

Starting the Cadence Incisive HDL Simulator from a Shell

To start the HDL simulator from a shell and include the HDL Verifier libraries, you need to first run the configuration script. See “Using the Configuration and Diagnostic Script for UNIX /Linux” on page 8-16.

After you have the configuration files, you can start the HDL simulator from the shell by typing:

```
% ncsim -f matlabconfigfile modelname
```

`matlabconfigfile` should be the name of the MATLAB configuration file you created with `syscheckin`. If you are connecting to Simulink, this should be the name of the Simulink configuration file. For example:

```
% ncsim -gui -f simulinkconfigfile modelname
```

Either way, you must also specify the path to the configuration file if it does not reside in the same folder as `ncsim.exe`.

You can also specify any other existing configuration files you may also be using with this call.

Starting `ncsim` in an Terminal

If you would like to bring up `ncsim` in an Xterm terminal, instead of launching the GUI, perform the following steps:

- 1 Start `hdldaemon` in MATLAB.
- 2 Start an Xterm from MATLAB in the background.
- 3 Run `ncsim` in the Xterm shell, having it call back to the `hdlserver` to run your `matlabtb` function as usual.
- 4 Specify that the `matlabtb` function use the `touch` command on a file to signal completion while a MATLAB script polls for completion.

The MATLAB script can then change test parameters and run more tests.

HDL Verifier Libraries

In general, you want to use the same compiler for all libraries linked into the same executable. The verification software provides many versions of the same library compilers that are available with the HDL simulators (usually some version of GCC). Using the same libraries helps the software stay compatible with other C++ libraries that may get linked into the HDL simulator, including SystemC libraries.

If you have any of these conditions, choose the version of the HDL Verifier library that matches the compiler used for that code:

- Link other third-party applications into your HDL simulator.
- Compile and link in SystemC code as part of your design or test bench.
- Write custom C/C++ applications and link them into your HDL simulator.

If you do not link any other code into your HDL simulator, you can use any version of the supplied libraries. The HDL Verifier launch command (`nclaunch` or `vsim`) chooses a default version of this library.

For examples on specifying HDL Verifier libraries when cosimulating across a network, see “Cross-Network Cosimulation” on page 8-22.

Library Names

The HDL Verifier HDL libraries use the following naming format:

```
edalink/extensions/version/arch/lib{version_short_name}{client_server_tag}
_{compiler_tag}.{libext}
```

where

Argument	Incisive Users	ModelSim Users
version	incisive	modelsim
arch	linux64	linux64, windows32, or windows64
version_short_name	lfihdl	lfmhdl
client_server_tag	c (MATLAB) or s (Simulink)	c (MATLAB) or s (Simulink)

Argument	Incisive Users	ModelSim Users
compiler_tag	gcc41, gcc44, tmwgcc	Linux: gcc433, gcc450, tmwgcc Windows 32: gcc421vc9 Windows 64: gcc450, tmwvs
libext	so	dll or so

Not all combinations are supported. See “Default Libraries” on page 8-11 for valid combinations.

For more on MATLAB build compilers, see MATLAB Build Compilers.

Default Libraries

HDL Verifier scripts fully support the use of default libraries.

The following table lists all the libraries shipped with the verification software for each supported HDL simulator. The default libraries for each platform are in bold text.

Default Libraries for use with ModelSim

Platform	MATLAB Library	c (MATLAB) or s (Simulink) Library
Linux 64	liblfmhdlc_tmwgcc.so liblfmhdlc_gcc433.so liblfmhdls_gcc450.dll	liblfmhdls_tmwgcc.so liblfmhdls_gcc433.so liblfmhdls_gcc450.dll
Windows 32	liblfmhdlc_gcc421vc9.dll	liblfmhdls_gcc421vc9.dll
Windows 64	liblfmhdlc_tmwvs.dll liblfmhdlc_gcc450.dll	liblfmhdls_tmwvs.dll liblfmhdls_gcc450.dll

Default Libraries for use with Incisive

Platform	MATLAB Library	Simulink Library
Linux 64	liblfihdlc_gcc41.so liblfihdlc_gcc44.so liblfihdlc_tmwgcc.so	liblfihdls_gcc41.so liblfihdls_gcc44.so liblfihdls_tmwgcc.so

Using an Alternative Library

The HDL Verifier launch commands contain parameters for specifying the HDL-side library.

- “Incisive Users: Using an Alternative Library” on page 8-12
- “ModelSim Users: Using an Alternative Library” on page 8-13

Incisive Users: Using an Alternative Library

You can use a different HDL-side library by specifying it explicitly using the `libfile` parameter to the `nc1aunch` MATLAB command. You should choose the version of the library that matches the compiler and system libraries you are using for any other C/C++ libraries linked into the HDL simulator. Depending on the version of your HDL simulator, you may need to explicitly set additional paths in the `LD_LIBRARY_PATH` environment variable.

For example, if you want to use a nondefault library:

- 1 Copy the system libraries from the MATLAB installation (found in `matlabroot/sys/os/linux64`, where `matlabroot` is your MATLAB installation) to the machine with the HDL simulator.
- 2 Modify the `LD_LIBRARY_PATH` environment variable to add the path to the system libraries that were copied in step 1.

Example: HDL Verifier Alternate Library Using `nc1aunch`

In this example, you are using a 64-bit Linux machine to run both MATLAB and Incisive. Because you have your own C++ application, and you are linking into `ncsim` that you used `tmwgcc` to compile, you are using the HDL Verifier version compiled with `tmwgcc`, instead of using the default library version compiled with GCC 4.1.

In MATLAB:

```
currPath = getenv('PATH');
setenv('PATH',['/tools/IUS-1110/bin:' currPath]);
nc1aunch('tclstart',{'exec ncvhdl inverter.vhd', ...
                  'exec ncelab -access +rwc inverter', ...
                  'hdlsimulink -gui inverter' }, ...
         'libfile','liblfihdls_tmwgcc');
```

The `PATH` is changed so that we get the desired version of the HDL simulator tools.

The library resolution can be verified using `ldd` from within the `ncsim` console GUI.

```
ncsim> exec ldd /path/to/matlab/toolbox/edalink/extensions/incisive/linux64/liblfihdls_
linux-vdso.so.1 => (0x00007fff2ffff000)
libpthread.so.0 => /lib/x86_64-linux-gnu/libpthread.so.0 (0x00007f98361a0000)
libstdc++.so.6 => /usr/lib/x86_64-linux-gnu/libstdc++.so.6 (0x00007f9835e99000)
libm.so.6 => /lib/x86_64-linux-gnu/libm.so.6 (0x00007f9835c16000)
libgcc_s.so.1 => /lib/x86_64-linux-gnu/libgcc_s.so.1 (0x00007f9835a00000)
```

```
libc.so.6 => /lib/x86_64-linux-gnu/libc.so.6 (0x00007f9835676000)
/lib64/ld-linux-x86-64.so.2 (0x00007f983661c000)
```

Example: HDL Verifier Alternate Library Using System Shell

This example shows how to load a Cadence Incisive simulator session by explicitly specifying the HDL Verifier library (default or not). By explicitly using a system shell, you can execute this example on the same machine as MATLAB, on a different machine, and even on a machine with a different operating system.

In this example, you are running the 64-bit Linux version of Cadence Incisive 10.2-s040; it does not matter what machine MATLAB is running on. Instead of using the default library version compiled with GCC 3.2.3 in the Cadence Incisive distribution, you are using the version compiled with GCC 4.4.

In a csh-compatible system shell:

```
csh> setenv PATH /tools/ius/lnx/tools/bin/64bit:${PATH}
csh> setenv LD_LIBRARY_PATH /tools/ius/lnx/tools/systemc/gcc/4.4-x86_64/install/lib64:${LD_LIBRARY_PATH}
csh> ncvhdl inverter.vhd
csh> ncelab -access +rwc inverter
csh> ncsim -tcl -loadvpi /tools/matlab/toolbox/edalink/extensions/incisive/linux64/lib1fihdlc_gcc44:matlabclient inverter.
```

The `PATH` is changed so that we get the desired version of the Cadence Incisive tools. Although `ncsim` will find any GCC libs in its installations, the `LD_LIBRARY_PATH` is changed to show how you might do this with a custom installation of GCC.

You can check the library resolution using `ldd` as in the previous example.

ModelSim Users: Using an Alternative Library

You can use a different HDL-side library by specifying it explicitly using the `libfile` parameter to the `vsim` MATLAB command. You should choose the version of the library that matches the compiler and system libraries you are using for any other C/C++ libraries linked into the HDL simulator. Depending on the version of your HDL simulator, you may need to explicitly set additional paths in the `LD_LIBRARY_PATH` environment variable.

For example, if you want to use a nondefault library:

- 1 Copy the system libraries from the MATLAB installation (found in `matlabroot/sys/os/`, where `matlabroot` is your MATLAB installation) to the machine with the HDL simulator.
- 2 Modify the `LD_LIBRARY_PATH` environment variable to add the path to the system libraries that were copied in step 1.

Example: HDL Verifier Alternative Library Using vsim

In this example, you are using a 64-bit Linux machine to run both MATLAB and ModelSim. Because you want to incorporate some SystemC designs, you are using the HDL Verifier version compiled with `gcc450`. You can download this version of GCC with its associated system libraries from Mentor Graphics, instead of using the default library version compiled with `tmwgcc`.

In MATLAB:

```
currPath = getenv('PATH');
currLdPath = getenv('LD_LIBRARY_PATH');
setenv('PATH',['/tools/modelsim-10.1c/bin:' currPath]);
setenv('LD_LIBRARY_PATH',['/tools/modelsim-10.1c/gcc-4.5.0-linux/lib:' currLdPath]);
vsim('tclstart',{'vlib work','vcom inverter.vhd','vsimulink inverter'}, ...
    'libfile','liblfmhds_gcc450');
```

You change the `PATH` so that you get the desired version of the ModelSim software. You change the `LD_LIBRARY_PATH` because the HDL simulator does not add the path to the system libraries.

The library resolution can be verified using `ldd` from within the ModelSim GUI:

```
exec ldd /path/to/matlab/toolbox/edalink/extensions/modelsim/linux64/liblfmhds_gcc450.so
linux-vdso.so.1 => (0x00007fff06652000)
libpthread.so.0 => /lib/x86_64-linux-gnu/libpthread.so.0 (0x00007f505083d000)
libstdc++.so.6 => /usr/lib/x86_64-linux-gnu/libstdc++.so.6 (0x00007f5050536000)
libm.so.6 => /lib/x86_64-linux-gnu/libm.so.6 (0x00007f50502b3000)
libgcc_s.so.1 => /lib/x86_64-linux-gnu/libgcc_s.so.1 (0x00007f505009d000)
libc.so.6 => /lib/x86_64-linux-gnu/libc.so.6 (0x00007f504fd13000)
/lib64/ld-linux-x86-64.so.2 (0x00007f5050cb8000)
```

Example: HDL Verifier Alternate Library Using System Shell

This example shows how to load a ModelSim session by explicitly specifying the HDL Verifier library (either the default or one of the alternatives). By explicitly using a system shell, you can execute this example on the same machine as MATLAB, on a different machine, and even on a machine with a different operating system.

In this example, you are running the 64-bit Linux version of QuestaSim 10.1a. It does not matter which machine is running MATLAB. Instead of using the HDL Verifier default library version compiled with `tmwgcc`, you are using the version compiled with GCC 4.5.0. You can download this version of GCC with its associated system libraries from Mentor Graphics.

In a `csh`-compatible system shell:

```
csh> setenv PATH /tools/questasim/bin:${PATH}
csh> setenv LD_LIBRARY_PATH /tools/mtigcc/gcc-4.5.0-linux_x86_64/lib64:${LD_LIBRARY_PATH}
```

```
csh> setenv MTI_VCO_MODE 64
csh> vlib work
csh> vcom +acc+inverter inverter.vhd
csh> vsim +acc+inverter -foreign "matlabclient /tools/matlab/toolbox/edalink
/extensions/modelsim/linux64/liblfmhdlc_gcc450.so" work.inverter
```

You change the *PATH* so that you get the desired version of the ModelSim software. You change the *LD_LIBRARY_PATH* because the HDL simulator does not add the path to the system libraries unless you are working with 10.1+ and have placed GCC at the root of the ModelSim installation.

You can check the library resolution using `ldd` as in the previous example.

Setup Diagnostics and Customization

- “Overview to the HDL Verifier Configuration and Diagnostic Script” on page 8-15
- “Using the Configuration and Diagnostic Script for UNIX /Linux” on page 8-16
- “Using the Configuration and Diagnostic Script with Windows” on page 8-20

Overview to the HDL Verifier Configuration and Diagnostic Script

HDL Verifier software provides a guided setup script (`syscheckmq` for ModelSim users and `syscheckin` for Incisive users) for configuring the MATLAB and Simulink connections to your simulator. This script works whether you have installed the verification software and MATLAB on the same machine as the HDL simulator or installed them on different machines.

The setup script creates a configuration file containing the location of the specified HDL Verifier MATLAB and Simulink libraries. You can then include this configuration with any other calls you make using the command `vsim` (ModelSim) or `ncsim` (Incisive) from the HDL simulator. You only need to run this script once.

Note: The HDL Verifier configuration and diagnostic script works only on UNIX and Linux. Windows users: please see instructions below.

You can find the setup scripts in the following folder:

```
matlabroot/toolbox/edalink/foundation/hdlink/scripts
```

Refer to “HDL Verifier Libraries” on page 8-10 for the application library for your platform.

For assistance in performing cross-network cosimulation, see “Cross-Network Cosimulation” on page 8-22.

After you have created your configuration files, see “Starting the HDL Simulator from a Shell” on page 8-8.

Using the Configuration and Diagnostic Script for UNIX /Linux

The setup script provides an easy way to configure your simulator setup to work with the HDL Verifier software.

The following is an example of running the setup script under the following conditions:

- You have installed HDL Verifier on a Linux 64 machine.
- You have moved the HDL Verifier libraries to a different location than where you first installed them (either to another folder or to another machine).
- You want to test the TCP/IP connection.

Running the Configuration and Diagnostic Script for ModelSim (syscheckmq)

Start the script by typing `syscheckmq` at a system prompt. The system returns the following information:

```
% syscheckmq
*****
Kernel name: Linux
Kernel release: 2.6.22.8-mw017
Machine: x86_64
*****
```

The script first returns the location of the HDL simulator installation (`vsim.exe`). If it does not find an installation, you receive an error message. Either provide the path to the installation or quit the script and install the HDL simulator. You are then prompted to accept this installation or provide a path to another one, after which you receive a message confirming the HDL simulator installation:

```
Found /hub/share/apps/HDLTools/ModelSim/modelsim-6.4a-tmw-000/modeltech/bin/vsim
on the path.
Press Enter to use the path we found or enter another one:
*****
/hub/share/apps/HDLTools/ModelSim/modelsim-6.4a-tmw-000/modeltech/bin/vsim -version
Model Technology ModelSim SE-64 vsim 6.4a Simulator 2008.08 Aug 28 2008
ModelSim mode: 32 bits
*****
```

Next, the script needs to know where it can find the HDL Verifier libraries.

```
Select method to search for HDL Verifier libraries:
1. Use libraries in a MATLAB installation.
2. Prompt me to specify the direct path to the libraries.
2
Enter the path to liblfmhdlc_tmwgcc.so and liblfmhdls_tmwgcc.so:
/tmp/extensions/modelsim/linux64
Found /tmp/extensions/modelsim/linux64/liblfmhdlc_tmwgcc.so
and /tmp/extensions/modelsim/linux64/liblfmhdls_tmwgcc.so.
```

The script then runs a dependency checker to check for supporting libraries. If any of the libraries cannot be found, you probably need to append your environment path to find them.

```
*****
Running dependency checker "ldd /tmp/extensions/modelsim/linux64/liblfmhdlc_tmwgcc.so".
Dependency checker passed.
Dependency status:
  librt.so.1 => /lib/librt.so.1 (0x00002acfe566e000)
  libstdc++.so.6 => /usr/lib/libstdc++.so.6 (0x00002acfe5778000)
  libm.so.6 => /lib/libm.so.6 (0x00002acfe5976000)
  libgcc_s.so.1 => /lib/libgcc_s.so.1 (0x00002acfe5af8000)
  libc.so.6 => /lib/libc.so.6 (0x00002acfe5c6000)
  /lib64/ld-linux-x86-64.so.2 (0x0000555555554000)
*****
```

This next step loads the HDL Verifier libraries and compiles a test module to verify the libraries loaded as expected.

```
Press Enter to load HDL Verifier or enter 'n' to skip this test:

Reading /mathworks/hub/share/apps/HDLTools/ModelSim/modelsim-6.4a-tmw-000/se/modeltech/
  linux_x86_64/./modelsim.ini "worklfx9019" maps to directory worklfx9019.
  (Default mapping)
Model Technology ModelSim SE-64 vlog 6.4a Compiler 2008.08 Aug 28 2008
-- Compiling module d9019

Top level modules:
  d9019

*****

Reading /mathworks/hub/share/apps/HDLTools/ModelSim/modelsim-6.4a-tmw-000/se/modeltech/tcl
  /vsim/pref.tcl

# 6.4a

# vsim -do exit -foreign {matlabclient /tmp/lfmconfig/linux64/liblfmhdlc_tmwgcc.so}
  -noautoldlibpath -c worklfx9019.d9019
# // ModelSim SE-64 6.4a Aug 28 Linux 2.6.22.8-mw017
.
.
.
# Loading work.d9019
# Loading /tmp/lfmconfig/linux64/liblfmhdlc_tmwgcc.so
# exit
```

```
*****
HDL Verifier libraries loaded successfully.
*****
```

Next, the script checks a TCP connection. If you choose to skip this step, the configuration file specifies use of shared memory. Both shared memory and socket configurations are in the configuration file; depending on your choice, one configuration or the other is commented out.

Press Enter to check for TCP connection or enter 'n' to skip this test:

Enter an available port [5001]

Enter remote host [localhost]

Press Enter to continue

```
ttcp_glnx -t -p5001 localhost
Connection successful
```

Lastly, the script creates the configuration file, unless for some reason you choose not to do so at this time.

```
*****
```

Press Enter to Create Configuration files or 'n' to skip this step:

```
*****
```

```
Created template files simulink9675.arg and matlab8675.arg. Inspect and modify
if desired.
```

```
*****
```

Diagnosis Completed

The template file names, in this example `simulink24255.arg` and `matlab24255.arg`, have different names each time you run this script.

After the script is complete, you can leave the configuration files where they are or move them to wherever it is convenient.

Running the Configuration and Diagnostic Script for Cadence Incisive (`syscheckin`)

Start the script by typing `syscheckin` at a system prompt. The system returns the following information:

```
% syscheckin
*****

Kernel name: Linux
Kernel release: 2.6.22.8-mw017
```



```
Machine: x86_64
```

```
*****
```

The script first returns the location of the HDL simulator installation (`ncsim.exe`). If it does not find an installation, you receive an error message. Either provide the path to the installation or quit the script and install the HDL simulator. You are then prompted to accept this installation or provide a path to another one, after which you receive a message confirming the HDL simulator installation:

```
Found /hub/share/apps/HDLTools/IUS/IUS-61-tmw-000/lnx/tools/bin/64bit/ncsim on the path.
Press Enter to use the path we found or enter another one:
```

```
*****
```

```
/hub/share/apps/HDLTools/IUS/IUS-61-tmw-000/lnx/tools/bin/64bit/ncsim -version
TOOL: ncsim(64) 06.11-s005
Cadence Incisive mode: 64 bits
```

```
*****
```

Next, the script needs to know where it can find the HDL Verifier libraries.

```
Select method to search for HDL Verifier libraries:
```

1. Use libraries in a MATLAB installation.
2. Prompt me to specify the direct path to the libraries.

```
2
```

```
Enter the path to liblfihdlc_gcc323.so and liblfihdls_gcc323.so:
```

```
tmp/extensions/incisive/linux64
```

```
Found /tmp/extensions/incisive/linux64/liblfihdlc_gcc323.so
```

```
and /tmp/extensions/incisive/linux64/liblfihdls_gcc323.so.
```

The script then runs a dependency checker to check for supporting libraries. If any of the libraries cannot be found, you probably need to append your environment path to find them.

```
*****
```

```
Running dependency checker "ldd /tmp/extensions/incisive/linux64/liblfihdlc_gcc323.so".
```

```
Dependency checker passed.
```

```
Dependency status:
```

```
librt.so.1 => /lib/librt.so.1 (0x00002b6119631000)
libstdc++.so.5 => /usr/lib/libstdc++.so.5 (0x00002b611973a000)
libm.so.6 => /lib/libm.so.6 (0x00002b6119916000)
libgcc_s.so.1 => /lib/libgcc_s.so.1 (0x00002b6119a99000)
libc.so.6 => /lib/libc.so.6 (0x00002b6119ba6000)
libpthread.so.0 => /lib/libpthread.so.0 (0x00002b6119de3000)
/lib64/ld-linux-x86-64.so.2 (0x0000555555554000)
```

```
*****
```

This next step loads the HDL Verifier libraries and compiles a test module to verify the libraries loaded as expected.

```
Press Enter to load HDL Verifier or enter 'n' to skip this test:
```

```
ncvlog(64): 06.11-s005: (c) Copyright 1995-2007 Cadence Design Systems, Inc.
```

```
define linux64 /work/matlab/toolbox/incisive/linux64
.
.
.
ncsim> exit

*****

HDL Verifier libraries loaded successfully.
*****
```

Next, the script checks a TCP connection. If you choose to skip this step, the configuration file specifies use of shared memory. Both shared memory and socket configurations are in the configuration file; depending on your choice, one configuration or the other is commented out.

Press Enter to check for TCP connection or enter 'n' to skip this test:

Enter an available port [5001]

Enter remote host [localhost]

Press Enter to continue

```
ttcp_glnx -t -p5001 localhost
Connection successful
```

Lastly, the script creates the configuration file, unless for some reason you choose not to do so at this time.

```
*****

Press Enter to Create Configuration files or 'n' to skip this step:

*****

Created template files simulink9675.arg and matlab8675.arg. Inspect and modify
if desired.
*****

Diagnosis Completed
```

The template file names, in this example `simulink24255.arg` and `matlab24255.arg`, have different names each time you run this script.

After the script is complete, you can leave the configuration files where they are or move them to wherever it is convenient.

Using the Configuration and Diagnostic Script with Windows

The setup script does not run on Windows. However, if your HDL simulator runs on Windows, you can use the configuration script on Windows by following these instructions:

- 1 Create a MATLAB configuration file. You may name it whatever you like; there are no file-naming restrictions. Enter the following text:

```
//Command file for HDL Verifier Link MATLAB library
//for use with Mentor Graphics ModelSim.
//Loading of foreign Library, usage example: vsim -f matlab14455.arg entity.
//You can manually change the following line to point to the applicable library.
//The default location of the 32-bit Windows library is at
//MATLABROOT/toolbox/edalink/extensions/modelsim/windows32/liblfmhdlc_gcc421vc9.dll.

-foreign "matlabclient c:/path/liblfmhdlc_gcc421vc9.dll"
```

where *path* is the path to the particular HDL Verifier shared library you want to invoke (in this example. See “HDL Verifier Libraries” on page 8-10).

For more information on the `-foreign` option, refer to the ModelSim documentation.

The comments in the above text are optional.

- 2 Create a Simulink configuration file and name it. There are no file-naming restrictions. Enter the following text:

```
//Command file for HDL Verifier Simulink library
//for use with Mentor Graphics ModelSim.
//Loading of foreign Library, usage example: vsim -f simulink14455.arg entity.
//You can manually change the following line to point to the applicable library.
//For example the default location of the 32-bit Windows library is at
//MATLABROOT/toolbox/edalink/extensions/modelsim/windows32/liblfmhdlc_gcc421vc9.dll.

//For socket connection uncomment and modify the following line:
-foreign "simlinkserver c:/path/liblfmhdlc_gcc421vc9.dll ; -socket 5001"

//For shared connection uncomment and modify the following line:
//-foreign "simlinkserver c:/path/liblfmhdlc_gcc421vc9.dll"
```

Where *path* is the path to the particular HDL Verifier shared library you want to invoke. See “HDL Verifier Libraries” on page 8-10.

Note: If you are going to use a TCP/IP socket connection, first confirm that you have an available port to put in this configuration file. Then, comment out whichever type of communication you will not be using.

The comments in the above text are optional.

After you have finished creating the configuration files, you can leave the files where they are or move them to another location that is convenient.

Cross-Network Cosimulation

In this section...

“Why Perform Cross-Network Cosimulation?” on page 8-22

“Preparing for Cross-Network Cosimulation” on page 8-22

“Performing Cross-Network Cosimulation Using MATLAB” on page 8-24

“Performing Cross-Network Cosimulation Using Simulink” on page 8-26

Why Perform Cross-Network Cosimulation?

You can perform cross-network cosimulation when your setup comprises one machine running MATLAB and Simulink software and another machine running the HDL simulator. Typically, a Windows-platform machine runs the MATLAB and Simulink software, while a Linux machine runs the HDL simulator. However, these procedures apply to any combination of platforms that HDL Verifier and the HDL simulator support.

Preparing for Cross-Network Cosimulation

Before you cosimulate between the HDL simulator and MATLAB or Simulink across a network, perform the following steps:

- 1 Create your design and testing files.

ModelSim Users

- Create and compile your HDL design, and create your MATLAB function (for MATLAB cosimulation) or Simulink model (for Simulink cosimulation).
- If you are going to cosimulate with Simulink, use the `-novopt` option when you compile so that the design is not optimized, and include the `-novopt` option when you issue the `vsim` command (see “Performing Cross-Network Cosimulation Using Simulink” on page 8-26). Using the `-novopt` option retains some unused signals from the design which are required by the Simulink model to run and display the results.

Incisive Users

Create, compile, and elaborate your HDL design, and create your MATLAB function (for MATLAB cosimulation), or Simulink model (for Simulink cosimulation).

2 Copy HDL Verifier libraries to the machine with the HDL simulator

- a Go to the system where you installed MATLAB. Then, find the folder in the MATLAB distribution where the HDL Verifier libraries reside.

You can usually find the libraries in the default installed folder:

```
matlabroot/toolbox/edalink/extensions/adaptor/platform/productlibraryname_  
compiler_tag.ext
```

where the variable shown in the following table have the values indicated.

Variable	Value
<i>matlabroot</i>	The location where you installed the MATLAB software; default value is "MATLAB/ <i>version</i> " where <i>version</i> is the installed release (for example, R2009a).
<i>adaptor</i>	<i>incisive</i> or <i>modelsim</i>
<i>platform</i>	The operating system of the machine with the HDL simulator, for example, <i>linux32</i> . (For more information, see "HDL Verifier Libraries" on page 8-10.)
<i>productlibraryname</i>	The name of the library files for MATLAB and for Simulink (for example, <i>liblbfmhd1c</i> , <i>liblbfmhd1s</i> for ModelSim users; <i>liblbfihd1c</i> , <i>liblbfihd1s</i> for Incisive users). See "HDL Verifier Libraries" on page 8-10.
<i>compiler_tag</i>	The compiler used to create the library (for example, <i>gcc32</i> or <i>spro</i>). For more information, see "HDL Verifier Libraries" on page 8-10.
<i>ext</i>	<i>d11</i> (dynamic link library—Windows only) or <i>so</i> (shared library extension)

For a list of all the HDL Verifier HDL shared libraries shipped, see "Default Libraries" on page 8-11.

- b From the MATLAB machine, copy the HDL Verifier libraries you plan to use (which you determined in step 2) to the machine where you installed the HDL simulator. Make note of the location to which you copied the libraries; you'll need this information when you are actually establishing the connection to the

HDL simulator. For purposes of this example, the sample code refers to the destination folder as `HDLSERVER_LIB_LOCATION`.

If you now want to cosimulate with MATLAB, see “Performing Cross-Network Cosimulation Using MATLAB” on page 8-24. If you want to cosimulate with Simulink, see “Performing Cross-Network Cosimulation Using Simulink” on page 8-26.

Performing Cross-Network Cosimulation Using MATLAB

To perform an HDL-simulator-to-MATLAB cosimulation session across a network, follow these steps:

ModelSim Users

- 1 In MATLAB, get an available socket using `hdldaemon`:

```
hdldaemon('socket',0)
```

Or assign one (that you know is available):

```
hdldaemon('socket',4449)
```

- 2 On the machine with the HDL simulator, launch the HDL simulator from a shell with the following command:

```
vsim -foreign "matlabclient /HDLSERVER_LIB_LOCATION/library_name;" design_name
```

where the arguments shown in the following table have the values indicated.

Argument	Value
<i>library_name</i>	The name of the library you copied to the machine with the HDL simulator (in “Preparing for Cross-Network Cosimulation” on page 8-22).
<i>design_name</i>	The VHDL or Verilog design you want to load

- 3 In the HDL simulator, schedule the test bench or component (`matlabcp` or `matlabtb`). Specify the socket port number from step 1 and the name of the host machine where `hdldaemon` is running.

Incisive Users

- 1 In MATLAB, get an available socket using `hdldaemon`:

```
hdldaemon('socket',0)
```

Or assign one:

```
hdldaemon('socket',4449)
```

- 2 Create a MATLAB configuration file (for loading the functions used in the HDL simulator) with the following contents:

```
//Command file for MATLAB HDL Verifier.
//Loading of foreign Library and HDL simulator functions.

-loadcfc /HDLSERVER_LIB_LOCATION/library_name:matlabclient
//TCL wrappers for MATLAB commands
-input @proc "nomatlabtb" "{args}" "{call" "nomatlabtb" "\$args}
-input @proc "matlabtb" "{args}" "{call" "matlabtb" "\$args}
-input @proc "matlabcp" "{args}" "{call" "matlabcp" "\$args}
-input @proc "matlabtbval" "{args}" "{call" "matlabtbval" "\$args}
```

Where *library_name* is the name of the library you copied in “Preparing for Cross-Network Cosimulation” on page 8-22. You may name this configuration file anything you like.

- 3 On the machine with the HDL simulator, launch the HDL simulator from a shell with the following command:

```
ncsim -gui -f matlab_config.file design_name
```

where the arguments shown in the following table have the values indicated.

Argument	Value
<i>matlab_config.file</i>	The name of the MATLAB configuration file (from step 3)
<i>design_name</i>	The VHDL or Verilog design you want to load

- 4 In the HDL simulator, schedule the test bench or component (`matlabcp` or `matlabtb`). Specify the socket port number from step 1 and the name of the host where `hdldaemon` is running.

Performing Cross-Network Cosimulation Using Simulink

When you want to perform an HDL-simulator-to-Simulink cosimulation session across a network, follow these steps:

ModelSim Users

- 1 Launch the HDL simulator from a shell with the following command:

```
vsim -foreign "simlinkserver /HDLSERVER_LIB_LOCATION/Library_name;
             -socket socket_num" -novopt design_name
```

where the arguments shown in the following table have the values indicated.

Argument	Value
<i>Library_name</i>	The name of the library you copied to the machine with the HDL simulator (in “Preparing for Cross-Network Cosimulation” on page 8-22).
<i>socket_num</i>	The socket number you have chosen for this connection
<i>design_name</i>	The VHDL or Verilog design you want to load

- 2 On the machine with MATLAB and Simulink, start Simulink and open your model.
- 3 Double-click on the HDL Cosimulation block to open the Function Block Parameters dialog box.
- 4 Click on the **Connections** tab.
 - a Clear “The HDL simulator is running on this computer.” HDL Verifier changes the Connection method to Socket.
 - b In the text box labeled **Host name**, enter the host name of the machine where the HDL simulator is located.
 - c In the text box labeled **Port number or service**, enter the socket number from step 1.
 - d Click **OK** to exit block dialog box, and save your changes.

Incisive Users

- 1 Launch the HDL simulator from a shell with the following command:

```
ncsim -gui -loadvpi "/HDLSERVER_LIB_LOCATION/library_name:simlinkserver"
+socket=socket_num design_name
```

where the arguments shown in the following table have the values indicated.

Argument	Value
<i>library_name</i>	The name of the library you copied to the machine with the HDL simulator (in “Preparing for Cross-Network Cosimulation” on page 8-22).
<i>socket_num</i>	The socket number you have chosen for this connection
<i>design_name</i>	The VHDL or Verilog design you want to load

- 2 On the machine with MATLAB and Simulink, start Simulink and open your model.
- 3 Double-click on the HDL Cosimulation block to open the Function Block Parameters dialog box.
- 4 Click on the **Connections** tab.
 - a Clear the check box labeled **The HDL simulator is running on this computer**. HDL Verifier changes the Connection method to Socket.
 - b In the **Host name** box, enter the host name of the machine where the HDL simulator is located.
 - c In the **Port number or service** box, enter the socket number from step 1.
 - d Click **OK** to exit block dialog box, and save your changes.

Next, run your simulation, add more blocks, or make other desired changes. For instructions on using Simulink and the HDL simulator for cosimulation, see “Simulink as a Test Bench” on page 4-2 or “Component Simulation with Simulink” on page 5-2.

Test Bench and Component Function Writing

In this section...

“Writing Functions Using the HDL Instance Object” on page 8-28

“Writing Functions Using Port Information” on page 8-32

Writing Functions Using the HDL Instance Object

This section explains how you use the `use_instance_obj` argument for MATLAB functions `matlabcp` and `matlabtb`. This feature replaces the `iport`, `oport`, `tnext`, `tnow`, and `portinfo` arguments of the MATLAB function definition. Instead, an HDL instance object is passed to the function as an argument. With this feature, `matlabcp` and `matlabtb` function callbacks get the HDL instance object passed in: to hold state, provide read/write access protection for signals, and allow you to add state as desired.

With this feature, you gain the following advantages:

- Use of the same MATLAB function to represent behavior for different instances of the same module in HDL without need to create one-off wrapper functions.
- No need for special `portinfo` argument on first invocation.
- No need to use persistent or global variables.
- Better feedback and protections on reading/writing of signals.
- Use of object fields to identify the instance path and whether the call comes from a component or test bench function.
- Use of the field argument to pass user-defined arguments from the `matlabcp` or `matlabtb` instantiation on the HDL side to the function callbacks.

The `use_instance_obj` argument is identical for both `matlabcp` and `matlabtb`. You include the `-use_instance_obj` argument with `matlabcp` or `matlabtb` in the following format:

```
matlabcp modelname -mfunc funcname -use_instance_obj
```

When you use `use_instance_obj`, HDL Verifier passes an HDL instance object to the function specified with the `-mfunc` argument. The function called has the following signature:

```
function MyFunctionName(hdl_instance_obj)
```

The HDL instance object, `hdl_instance_obj`, has the fields shown in the following table.

Field	Read/ Write Access	Description
<code>tnext</code>	Write only	Used to schedule a callback during the set time value. This field is the same as <code>tnext</code> in the old <code>portinfo</code> structure. For example: <pre>hdl_instance_obj.tnext = hdl_instance_obj.tnow + 5e-9</pre> <p>This line of code schedules a callback at time = 5 nanoseconds from <code>tnow</code>.</p>
<code>userdata</code>	Read/Write	Stores state variables of the current <code>matlabcp</code> instance. You can retrieve the variables the next time the callback of this instance is scheduled.
<code>simstatus</code>	Read only	Stores the status of the HDL simulator. The HDL Verifier software sets this field to 'Init' during the first callback for this particular instance and to 'Running' thereafter. This field value is a read-only property. <pre>>> hdl_instance_obj.simstatus</pre> <pre>ans=</pre> <pre> Init</pre>
<code>instance</code>	Read only	Stores the full path of the Verilog/VHDL instance associated with the callback. <code>instance</code> is a read-only property. The value of this field equals that of the module instance specified with the function call. For example: <p>In the HDL simulator:</p> <pre>hdlsim> matlabcp osc_top -mfunc oscfilter use_instance_obj</pre> <p>In MATLAB:</p> <pre>>> hdl_instance_obj.instance</pre> <pre>ans=</pre> <pre> osc_top</pre>
<code>argument</code>	Read only	Stores the argument set by the <code>-argument</code> option of <code>matlabcp</code> . For example:

Field	Read/ Write Access	Description
		<pre>matlabtb osc_top -mfunc oscfilter -use_instance_obj -argument foo</pre> <p>The verification software supports the <code>-argument</code> option only when you use it with <code>-use_instance_obj</code>, otherwise the argument is ignored. <code>argument</code> is a read-only property.</p> <pre>>>hdl_instance_obj.argument ans= foo</pre>
<code>portinfo</code>	Read only	<p>Stores information about the VHDL and Verilog ports associated with this instance. This field value is a read-only property, which has a field structure that describes the ports defined for the associated HDL module. For each port, the <code>portinfo</code> structure passes information such as the port's type, direction, and size. For more information on port data, see "Gaining Access to and Applying Port Information" on page 8-35.</p> <pre>hdl_instance_obj.portinfo.field1.field2.field3</pre> <hr/> <p>Note: When you use <code>use_instance_obj</code>, you access <code>tscale</code> through the HDL instance object. If you do not use <code>use_instance_obj</code>, you can still access <code>tscale</code> through <code>portinfo</code>.</p>
<code>tscale</code>	Read only	<p>Stores the resolution limit (tick) in seconds of the HDL simulator. This field value is a read-only property.</p> <pre>>>hdl_instance_obj.tscale ans= 1.0000e-009</pre> <hr/> <p>Note: When you use <code>use_instance_obj</code>, you access <code>tscale</code> through the HDL instance object. If you do not use <code>use_instance_obj</code>, you can still access <code>tscale</code> through <code>portinfo</code>.</p>

Field	Read/ Write Access	Description
tnow	Read only	Stores the current time. This field value is a read-only property. <code>hdl_instance_obj.tnext = hld_instance_obj.tnow + fastestrate;</code>
portvalues	Read/Write	Stores the current values of and sets new values for the output and input ports for a <code>matlabcp</code> instance. For example: <pre>>> hdl_instance_obj.portvalues ans = Read Only Input ports: clk_enable: [] clk: [] reset: [] Read/Write Output ports: sine_out: [22x1 char]</pre>
linkmode	Read only	Stores the status of the callback. The HDL Verifier software sets this field to 'testbench' if the callback is associated with <code>matlabtb</code> and 'component' if the callback is associated with <code>matlabcp</code> . This field value is a read-only property. <pre>>> hdl_instance_obj.linkmode ans= component</pre>

Example: Using `matlabcp` and the HDL Instance Object

In this example, the HDL simulator makes repeated calls to `matlabcp` to bind multiple HDL instances to the same MATLAB function. Each call contains `-argument` as a constructor parameter to differentiate behavior.

```
> matlabcp u1_filter1x -mfunc osc_filter -use_instance_obj -argument "oversample=1"
> matlabcp u1_filter8x -mfunc osc_filter -use_instance_obj -argument "oversample=8"
> matlabcp u2_filter8x -mfunc osc_filter -use_instance_obj -argument "oversample=8"
```

The MATLAB function callback, `osc_filter.m`, sets up user instance-based state using `obj.userdata`, queries port and simulation context using other `obj` fields, and uses the passed in `obj.argument` to differentiate behavior.

```
function osc_filter(obj)
if (strcmp(obj.simstatus,'Init'))
  ud = struct('Nbits', 22, 'Norder', 31, 'clockperiod', 80e-9, 'phase', 1);
  eval(obj.argument);
  if (~exist('oversample','var'))
```

```

        error('HdlLinkDemo:UseInstanceObj:BadCtorArg', ...
            'Bad constructor arg to osc_filter callback. Expecting
            ''oversample=value''.');
    end
    ud.oversample      = oversample;
    ud.oversampleperiod = ud.clockperiod/ud.oversample;
    ud.InDelayLine    = zeros(1,ud.Norder+1);

    centerfreq = 70/256;
    passband    = [centerfreq-0.01, centerfreq+0.01];
    b           = fir1((ud.Norder+1)*ud.oversample-1, passband./ud.oversample);
    ud.Hresp    = ud.oversample .* b;

    obj.userdata = ud;
end
...

```

Writing Functions Using Port Information

- “MATLAB Function Syntax and Function Argument Definitions” on page 8-32
- “Oscfilter Function Example” on page 8-34
- “Gaining Access to and Applying Port Information” on page 8-35

MATLAB Function Syntax and Function Argument Definitions

The syntax of a MATLAB component function is

```
function [oport, tnext] = MyFunctionName(iport, tnow, portinfo)
```

The syntax of a MATLAB test bench function is

```
function [iport, tnext] = MyFunctionName(oport, tnow, portinfo)
```

The input/output arguments (*iport* and *oport*) for a MATLAB component function are the reverse of the port arguments for a MATLAB test bench function. That is, the MATLAB component function returns signal data to the *outputs* and receives data from the *inputs* of the associated HDL module.

For more information on using *tnext* and *tnow* for simulation scheduling, see “Schedule Component Functions Using the *tnext* Parameter” on page 2-21.

The following table describes each of the test bench and component function parameters and the roles they play in each of the functions.

Parameter	Test Bench	Component
<i>iport</i>	<i>Output</i>	<i>Input</i>

Parameter	Test Bench	Component
	Structure that forces (by deposit) values onto signals connected to input ports of the associated HDL module.	Structure that receives signal values from the input ports defined for the associated HDL module at the time specified by <code>tnow</code> .
<code>tnext</code>	<i>Output, optional</i> Specifies the time at which the HDL simulator schedules the next callback to MATLAB. <code>tnext</code> should be initialized to an empty value (<code>[]</code>). If <code>tnext</code> is not later updated, no new entries are added to the simulation schedule.	<i>Output, optional</i> Same as test bench.
<code>oport</code>	<i>Input</i> Structure that receives signal values from the output ports defined for the associated HDL module at the time specified by <code>tnow</code> .	<i>Output</i> Structure that forces (by deposit) values onto signals connected to output ports of the associated HDL module.
<code>tnow</code>	<i>Input</i> Receives the simulation time at which the MATLAB function is called. By default, time is represented in seconds. For more information see “Schedule Component Functions Using the <code>tnext</code> Parameter” on page 2-21.	Same as test bench.

Parameter	Test Bench	Component
portinfo	<p><i>Input</i></p> <p>For the first call to the function only (at the start of the simulation), <code>portinfo</code> receives a structure whose fields describe the ports defined for the associated HDL module. For each port, the <code>portinfo</code> structure passes information such as the port's type, direction, and size.</p>	Same as test bench.

If you are using `matlabcp`, initialize the function outputs to empty values at the beginning of the function as in the following example:

```
tnext = [];
oport = struct();
```

Note: When you import VHDL signals, signal names in `oport`, `oport`, and `portinfo` are returned in all capitals.

You can use the port information to create a generic MATLAB function that operates differently depending on the port information supplied at startup. For more information on port data, see “Gaining Access to and Applying Port Information” on page 8-35.

Oscfilter Function Example

The following code gives the definition of the `oscfilter` MATLAB component function.

```
function [oport,tnext] = oscfilter(iport, tnow, portinfo)
```

The function name `oscfilter`, differs from the entity name `u_osc_filter`. Therefore, the component function name must be passed in explicitly to the `matlabcp` command that connects the function to the associated HDL instance using the `-mfunc` parameter.

The function definition specifies all required input and output parameters, as listed here:

<code>oport</code>	Forces (by deposit) values onto the signals connected to the entity's output ports, <code>filter1x_out</code> , <code>filter4x_out</code> and <code>filter8x_out</code> .
--------------------	---

<code>tnext</code>	Specifies a time value that indicates when the HDL simulator will execute the next callback to the MATLAB function.
<code>iport</code>	Receives HDL signal values from the entity's input port, <code>osc_in</code> .
<code>tnow</code>	Receives the current simulation time.
<code>portinfo</code>	For the first call to the function, receives a structure that describes the ports defined for the entity.

The following figure shows the relationship between the HDL entity's ports and the MATLAB function's `iport` and `oport` parameters (example shown is for use with ModelSim).

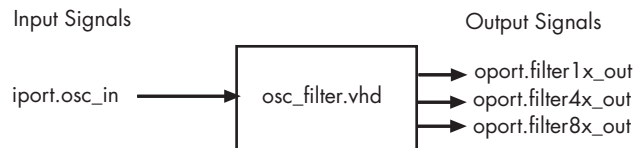

Gaining Access to and Applying Port Information

HDL Verifier software passes information about the entity or module under test in the `portinfo` structure. The `portinfo` structure is passed as the third argument to the function. It is passed only in the first call to your ModelSim function. You can use the information passed in the `portinfo` structure to validate the entity or module under simulation. Three fields supply the information, as indicated in the next sample. . The content of these fields depends on the type of ports defined for the VHDL entity or Verilog module.

```
portinfo.field1.field2.field3
```

The following table lists possible values for each field and identifies the port types for which the values apply.

HDL Port Information

Field...	Can Contain...	Which...	And Applies to...
<code>field1</code>	<code>in</code>	Indicates the port is an input port	All port types
	<code>out</code>	Indicates the port is an output port	All port types
	<code>inout</code>	Indicates the port is a bidirectional port	All port types

Field...	Can Contain...	Which...	And Applies to...
	<code>tscale</code>	Indicates the simulator resolution limit in seconds as specified in the HDL simulator	All types
<i>field2</i>	<i>portname</i>	Is the name of the port	All port types
<i>field3</i>	<code>type</code>	Identifies the port type For VHDL: <code>integer</code> , <code>real</code> , <code>time</code> , or <code>enum</code> For Verilog: <code>'verilog_logic'</code> identifies port types <code>reg</code> , <code>wire</code> , <code>integer</code>	All port types
	<code>right</code> <i>(VHDL only)</i>	The VHDL RIGHT attribute	VHDL <code>integer</code> , <code>natural</code> , or <code>positive</code> port types
	<code>left</code> <i>(VHDL only)</i>	The VHDL LEFT attribute	VHDL <code>integer</code> , <code>natural</code> , or <code>positive</code> port types
	<code>size</code>	VHDL: The size of the matrix containing the data Verilog: The size of the bit vector containing the data	All port types
	<code>label</code>	VHDL: A character literal or label Verilog: the string <code>'01ZX'</code>	VHDL: Enumerated types, including predefined types <code>BIT</code> , <code>STD_LOGIC</code> , <code>STD_ULONGIC</code> , <code>BIT_VECTOR</code> , and <code>STD_LOGIC_VECTOR</code> Verilog: All port types

The first call to the ModelSim function has three arguments including the `portinfo` structure. Checking the number of arguments is one way you can verify that `portinfo` was passed. For example:

```
if(nargin ==3)
    tscale = portinfo.tscale;
end
```

Simulation Speed Improvement Tips

In this section...

“Obtaining Baseline Performance Numbers” on page 8-37

“Analyzing Simulation Performance” on page 8-37

“Cosimulating Frame-Based Signals with Simulink” on page 8-38

Obtaining Baseline Performance Numbers

You can baseline the performance numbers by timing the execution of the HDL and the Simulink model separately and adding them together; you may not expect better performance than that. Make sure that the separate simulations are representative: running an HDL-only simulator with unrealistic input stimulus could be much faster than when realistic input stimulus is provided.

Analyzing Simulation Performance

While cosimulation entails a certain amount of overhead, sometimes the HDL simulation itself also slows performance. Ask yourself these questions when trying to analyze and improve performance:

Consideration	Suggestions for Improving Speed
Are you are using NFS or other remote file systems?	How fast is the file system? Consider using a different type or expect that the file system you're using will impact performance.
Are you using separate machines for Simulink and the HDL simulator?	How fast is the network? Wait until the network is quieter or contact your system administrator for advice on improving the connection.
Are you using the same machine for Simulink and the HDL simulator?	<ul style="list-style-type: none"> • Are you using shared pipes instead of sockets? Shared memory is faster. • Are the Simulink and HDL processes large enough to cause swaps to disk? Consider adding more memory; otherwise be aware that you're running

Consideration	Suggestions for Improving Speed
	a huge process and expect it to impact performance.
Are you using <i>optimal</i> (that is, as large as possible) Simulink sample rates on the HDL Cosimulation block?	<p>For example, if you set the output sample rate to 1 but only use every 10th sample, you could make the rate 10 and reduce the traffic between Simulink and the HDL simulator.</p> <p>Another example is if you place a very fast clock as an input to the HDL Cosimulation block, but have none of the other inputs need such a fast rate. In that case, you should generate the clock in HDL or (Incisive and ModelSim users only) via the Clocks or Simulation pane on the HDL Cosimulation block.</p>
ModelSim users: Are you compiling/ elaborating the HDL using the <code>vopt</code> flow?	Use <code>vopt</code> to optimize your design for maximum (HDL) simulator speed (ModelSim users only).
Are you using Simulink Accelerator™ mode?	Acceleration mode can speed up the execution of your model. See "Accelerating Models" in the <i>Simulink User's Guide</i> .
If you have the Communications System Toolbox software, have you considered using Framed signals?	Framed signals reduce the number of Simulink/HDL interactions.

Cosimulating Frame-Based Signals with Simulink

Overview to Cosimulation with Frame-Based Signals

Frame-based processing can improve the computational time of your Simulink models, because multiple samples can be processed at once. Use of frame-based signals also lets you simulate the behavior of frame-based systems more realistically. The HDL Simulator block supports processing of single-channel frame-based signals.

A *frame* of data is a collection of sequential samples from a single channel or multiple channels. One frame of a single-channel signal is represented by a M -by-1 column vector. A signal is *frame based* if it is propagated through a model one frame at a time.

Frame-based processing requires the DSP System Toolbox software. Source blocks from the Sources library let you specify a frame-based signal by setting the **Samples per frame** block parameter. Most other signal processing blocks preserve the frame status of an input signal. You can use the Buffer block to buffer a sequence of samples into frames.

See “Working with Signals” in the DSP System Toolbox documentation for detailed information about frame-based processing.

Using Frame-Based Processing

You do not need to configure the HDL Simulator block in any special way for frame-based processing. To use frame-based processing in a cosimulation, connect one or more single-channel frame-based signals to one or more input ports of the HDL Simulator block. All such signals must meet the requirements described in “Frame-Based Processing Requirements and Restrictions” on page 8-39. The HDL Simulator block configures any outputs for frame-based operation at the suitable frame size.

Use of frame-based signals affects only the Simulink side of the cosimulation. The behavior of the HDL code under simulation in the HDL simulator does not change in any way. Simulink assumes that HDL simulator processing is sample based. Simulink assembles samples acquired from the HDL simulator into frames as required. Conversely, Simulink transmits output data to the HDL simulator in frames, which are unpacked and processed by the HDL simulator one sample at a time.

Frame-Based Processing Requirements and Restrictions

Observe the following restrictions and requirements when connecting frame-based signals in to an HDL Simulator block:

- Connection of mixed frame-based and sample-based signals to the same HDL Simulator block is not supported.
- Only single-channel frame-based signals can be connected to the HDL Simulator block. Use of multichannel (matrix) frame-based signals is not supported in this release.
- All frame-based signals connected to the HDL Simulator block must have the same frame size.

Frame-based processing in the Simulink model is transparent to the operation of the HDL model under simulation in the HDL simulator. The HDL model is presumed to be sample-based. The following constraint also applies to the HDL model under simulation in the HDL simulator:

Specify VHDL signals as scalar values, not vectors or arrays (with the exception of bit vectors. VHDL and Verilog bit vectors are converted to the suitably-sized fixed-point scalar data type by the HDL Cosimulation block).

Frame-Based Cosimulation Example

This example shows the use of the HDL Simulator block to cosimulate a VHDL implementation of a simple lowpass filter. In the example, you will compare the performance of the simulation using frame-based and sample-based signals.

Note: This tutorial is specific to ModelSim users; however, much of the process will be the same for Incisive users.

The example files are (in *matlabroot*):

- The example model:

```
\toolbox\edalink\extensions\modelsim\modelsimemos\frame_filter_cosim
```

- VHDL code for the filter to be cosimulated:

```
\toolbox\edalink\extensions\modelsim\modelsimemos\VHDL\frame_demos\lp_fir_8k.vhd
```

The filter was designed with FDATool and the code was generated by the Filter Design HDL Coder™.

The example uses the data file *matlabroot\toolbox\signal\signal\mtlb.mat* as an input signal. This file contains a speech signal. The sample data is of data type `double`, sampled at a rate of 8 kHz.

The next figure shows the `frame_filter_cosim` model.

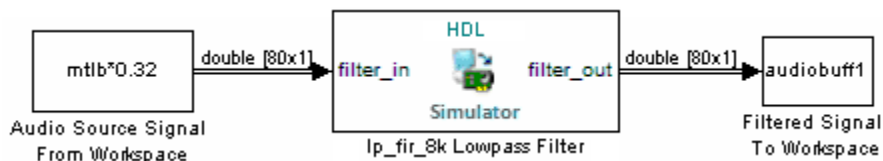

The **Audio Source Signal From Workspace** block provides an input signal from the workspace variable `mtlb`. The block is configured for an 8 kHz sample rate, with a frame size of 80, as shown in this figure.

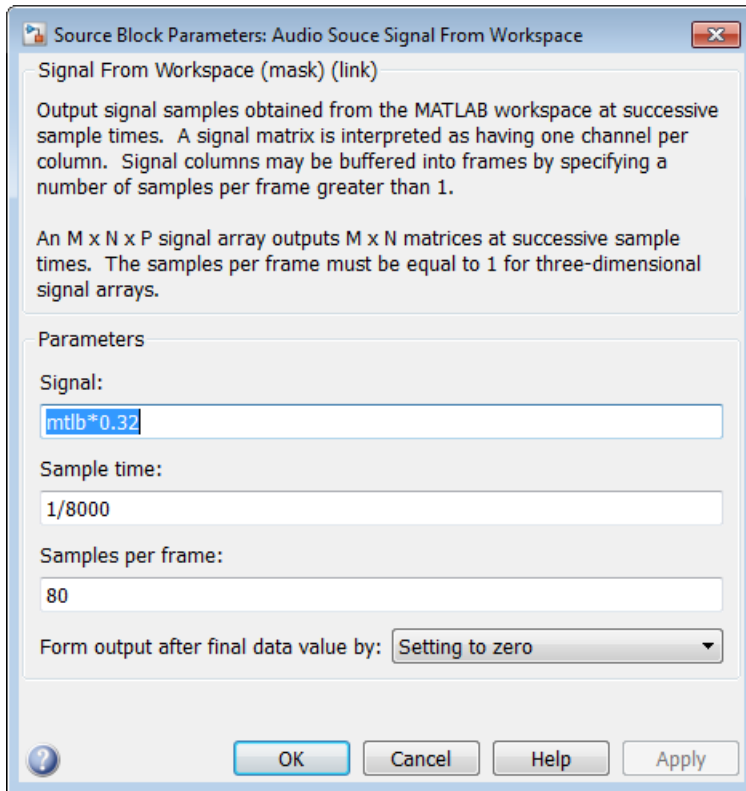

The sample rate and frame size of the input signal propagate throughout the model.

The VHDL code file `lp_fir_8k.vhd` implements a simple lowpass FIR filter with a cutoff frequency of 1500 Hz. The **HDL Simulator** block simulates this HDL module. The **HDL Simulator** block ports and clock signal are configured to match the corresponding signals on the VHDL entity.

For the ModelSim simulation to execute as we want it to, the `clk_enable` signal of the `lp_fir_8k` entity must be forced high. The signal is forced by a pre-simulation command transmitted by the **HDL Simulator** block. The command has been entered

into the **Simulation** pane of the HDL Simulator block, as shown in the following figure (example shown for use with ModelSim).

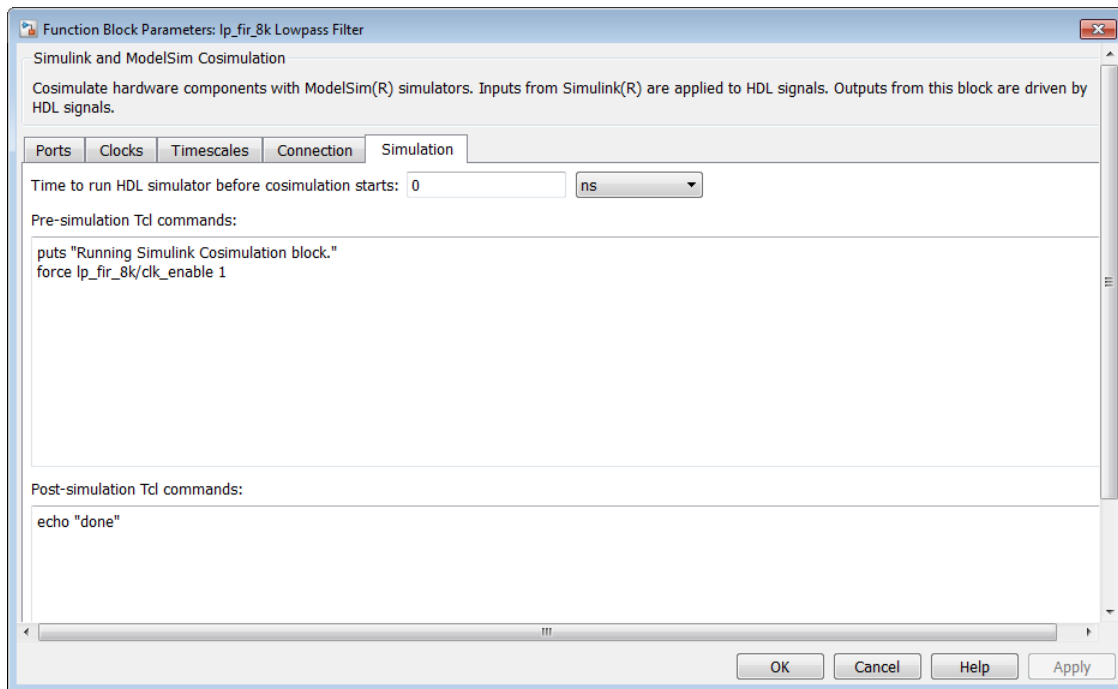

The HDL Simulator block returns output in the workspace variable `audiobuff1` via the Filtered Signal To Workspace block.

To run the cosimulation, perform the following steps:

- 1 Start MATLAB and make it your active window.
- 2 Set up and change to a writable working folder that is outside the context of your MATLAB installation folder.
- 3 Add the example folder to the MATLAB path:

```
matlabroot\toolbox\edalink\extensions\modelsim\modelsimemos\frame_cosim
```
- 4 Copy the VHDL file `lp_fir_8k.vhd` to your working folder.
- 5 Open the example model.

```
open frame_filter_cosim.mdl
```

- 6 Load the source speech signal, which will be filtered, into the MATLAB workspace.

```
load mtlb
```

If you have a compatible sound card, you can play back the source signal by typing the following commands at the MATLAB command prompt:

```
a = audioplayer(mtlb,8000);
play(a);
```

- 7 Start ModelSim by typing the following command at the MATLAB command prompt:

```
vsim
```

The ModelSim window should now be active. If not, start it.

- 8 At the ModelSim prompt, create a design library, and compile the VHDL filter code from the source file `lp_fir_8k.vhd`, by typing the following commands:

```
vlib work
vmap work work
vcom lp_fir_8k.vhd
```

- 9 The lowpass filter to be simulated is defined as the entity `lp_fir_8k`. At the ModelSim prompt, load the instantiated entity `lp_fir_8k` for cosimulation:

```
vsimulink lp_fir_8k
```

ModelSim is now set up for cosimulation.

- 10 Start MATLAB. Run a simulation and measure elapsed time as follows:

```
t = clock; sim(gcs); etime(clock,t)
```

```
ans =
```

```
2.7190
```

The timing in this code excerpt is typical for a run of this model given a simulation **Stop time** of 1 second and a frame size of 80 samples. Timings are system-dependent and will vary slightly from one simulation run to the next.

Take note of the timing you obtained. For the next simulation run, you will change the model to sample-based operation and obtain a comparative timing.

- 11 MATLAB stores the filtered audio signal returned from ModelSim in the workspace variable `audiobuff1`. If you have a compatible sound card, you can play back the

filtered signal to hear the effect of the lowpass filter. Play the signal by typing the following commands at the MATLAB command prompt:

```
b = audioplayer(audiobuff1,8000);
play(b);
```

- 12 Open the block parameters dialog box of the **Audio Source Signal From Workspace** block and set the **Samples per frame** property to 1, as shown in this figure.

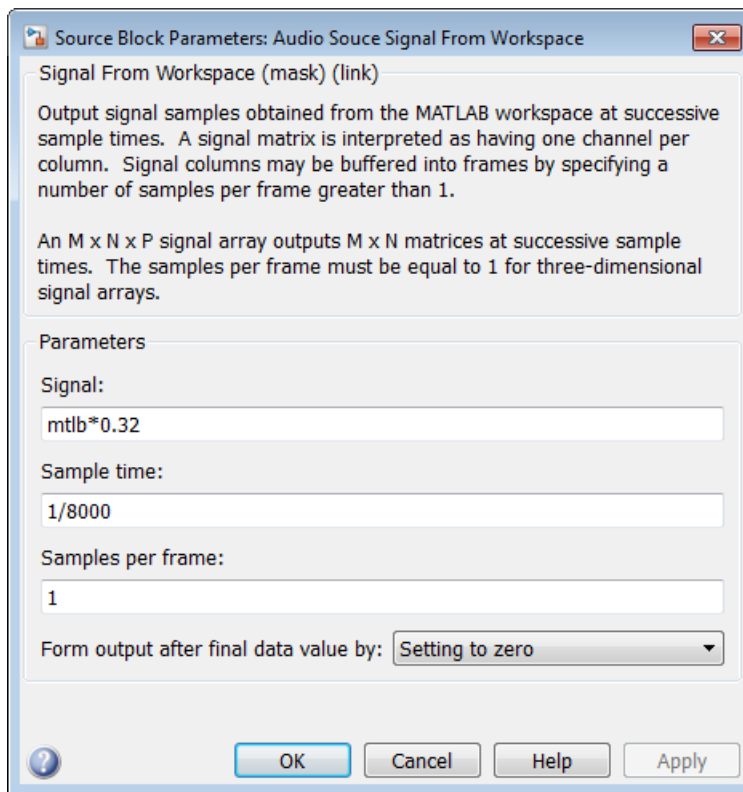

- 13 Close the dialog box, and select the Simulink window. Select **Simulation > Update diagram**.

Now the source signal (and all signals inheriting from it) is a scalar.

- 14 Start ModelSim. At the ModelSim prompt, type

```
restart
```

- 15** Start MATLAB. Run a simulation and measure elapsed time as follows:

```
t = clock; sim(gcs); etime(clock,t)
```

```
ans =
```

```
3.8440
```

Observe that the elapsed time has increased significantly with a sample-based input signal. The timing in this code excerpt is typical for a sample-based run of this model given a simulation **Stop time** of 1 second. Timings are system-dependent and will vary slightly from one simulation run to the next.

- 16** Close down the simulation in an orderly way. In ModelSim, stop the simulation by selecting **Simulate > End Simulation**, and quit ModelSim. Then, close the Simulink model window.

Race Conditions in HDL Simulators

In this section...

“Avoiding Race Conditions” on page 8-46

“Potential Race Conditions in Simulink Cosimulation Sessions” on page 8-46

“Potential Race Conditions in MATLAB Cosimulation Sessions” on page 8-47

“Further Reading” on page 8-48

Avoiding Race Conditions

A well-known issue in hardware simulation is the potential for different results on different runs when race conditions are present. Because the HDL simulator is a highly parallel execution environment, you must write the HDL such that the results do not depend on the ordering of process execution.

Although there are well-known coding idioms for achieving a realistic simulation of a design under test, you must always take special care at the test bench/DUT interfaces for applying stimulus and reading results, even in pure HDL environments. For an HDL/foreign language interface, such as with a Simulink or MATLAB cosimulation session, the problem is compounded if you do not have a common synchronization signal, such as a clock, coordinating the flow of data.

Potential Race Conditions in Simulink Cosimulation Sessions

All the signals on the interface of an HDL `Cosimulation` block in the Simulink library have an intrinsic sample rate associated with them. This sample rate can be thought of as an implicit clock that controls the simulation time at which a value change can occur. Because this implicit clock is completely unknown to the HDL engine (that is, it is not an HDL signal), the times at which input values are driven into the HDL or output values are sampled from the HDL are asynchronous to any clocks coded in HDL directly, even if they are nominally at the same frequency.

For Simulink value changes scheduled to occur at a specific simulation time, the HDL simulator does not make any guarantees as to the order that value change occurs versus some other blocking signal assignment. Thus, if the Simulink values are driven/sampled at the same time as an active clock edge in the HDL, there is a race condition.

For cases where your active HDL clock edge and your intrinsic Simulink active clock edges are at the same frequency, you can promote desired data propagation by offsetting one of those edges. Because the Simulink sample rates are always aligned with time 0, you can accomplish this offset by shifting the active clock edge in the HDL off of time 0. If you are coding the clock stimulus in HDL, use a delay operator ("after" or "#") to accomplish this offset.

When using a Tcl "force" command to describe the clock waveform, you can simply put the first active edge at some nonzero time. Using a nonzero value allows a Simulink sample rate that is the same as the fundamental clock rate in your HDL. This example shows a 20 ns clock (so the Simulink sample rates will also be every 20 ns) with an active positive edge that is offset from time 0 by 2 ns (example shown for use with Incisive):

```
> force top.clk = 1'b0 -after 0 ns 1'b1 -after 2 ns 1'b0
      -after 12 ns -repeat 20 ns
```

For HDL Cosimulation blocks with Clock panes, you can define the clock period and active edge in that pane. The waveform definition places the **non-active** edge at time 0 and the **active** edge at time T/2. This placement sets the maximum setup and hold times for a clock with a 50% duty cycle.

If the Simulink sample rates are at a different frequency than the HDL clocks, then you must synchronize the signals between the HDL and Simulink as you would do with any multiple time-domain design, even one in pure HDL. For example, you can place two synchronizing flip-flops at the interface.

If your cosimulation does not include clocks, then you must also treat the interfacing of Simulink and the HDL code as being between asynchronous time domains. You may need to over-sample outputs to see that all data transitions are captured.

Potential Race Conditions in MATLAB Cosimulation Sessions

When you use the `-sensitivity`, `-rising_edge`, or `-falling_edge` scheduling options to `matlabtb` or `matlabcp` to trigger MATLAB function calls, the propagation of values follow the same semantics as a pure HDL design; the triggers must occur before the results can be calculated. You still can have race conditions, but they can be analyzed within the HDL alone.

However, when you use the `-time` scheduling option to `matlabtb` or `matlabcp`, or use `tnext` within the MATLAB function itself, the driving of signal values or sampling of signal values cannot be guaranteed in relation to any HDL signal changes. It is as if the

potential race conditions in that time-based scheduling are like an implicit clock that is unknown to the HDL engine and not visible by just looking at the HDL code.

The remedies are the same as for the Simulink signal interfacing: make sure that the sampling and driving of signals does not occur at the same simulation times as the MATLAB function calls.

Further Reading

Problems interfacing designs from test benches and foreign languages, including race conditions in pure HDL environments, are well-known and extensively documented. Some texts that describe these issues include:

- The documentation for each vendor's HDL simulator product
- The HDL standards specifications
- Writing Testbenches: Functional Verification of HDL Models, Janick Bergeron, 2nd edition, © 2003
- Verilog and SystemVerilog Gotchas, Stuart Sutherland and Don Mills, © 2007
- SystemVerilog for Verification: A Guide to Learning the Testbench Language Features, Chris Spear, © 2007
- Principles of Verifiable RTL Design, Lionel Bening and Harry D. Foster, © 2001

Data Type Conversions

In this section...

“Converting HDL Data to Send to MATLAB” on page 8-49

“Array Indexing Differences Between MATLAB and HDL” on page 8-51

“Converting Data for Manipulation” on page 8-52

“Converting Data for Return to the HDL Simulator” on page 8-53

Converting HDL Data to Send to MATLAB

If your HDL application needs to send HDL data to a MATLAB function, you may first need to convert the data to a type supported by MATLAB and the HDL Verifier software.

To program a MATLAB function for an HDL model, you must understand the type conversions required by your application. You may also need to handle differences between the array indexing conventions used by the HDL you are using and MATLAB (see following section).

The data types of arguments passed in to the function determine the following:

- The types of conversions required before data is manipulated
- The types of conversions required to return data to the HDL simulator

The following table summarizes how the HDL Verifier software converts supported VHDL data types to MATLAB types based on whether the type is scalar or array.

VHDL-to-MATLAB Data Type Conversions

VHDL Types...	As Scalar Converts to...	As Array Converts to...
STD_LOGIC, STD_ULONGIC, and BIT	A character that matches the character literal for the desired logic state.	
STD_LOGIC_VECTOR, STD_ULONGIC_VECTOR, BIT_VECTOR, SIGNED, and UNSIGNED		A column vector of characters (as defined in VHDL Conversions for the HDL Simulator) with one bit per character.
Arrays of STD_LOGIC_VECTOR, STD_ULONGIC_VECTOR,		An array of characters (as defined above) with a size that is equivalent to the VHDL port size.

VHDL Types...	As Scalar Converts to...	As Array Converts to...
BIT_VECTOR, SIGNED, and UNSIGNED		
INTEGER and NATURAL	Type <code>int32</code> .	Arrays of type <code>int32</code> with a size that is equivalent to the VHDL port size.
REAL	Type <code>double</code> .	Arrays of type <code>double</code> with a size that is equivalent to the VHDL port size.
TIME	Type <code>double</code> for time values in seconds and type <code>int64</code> for values representing simulator time increments (see the description of the <code>'time'</code> option in <code>hdldaemon</code>).	Arrays of type <code>double</code> or <code>int64</code> with a size that is equivalent to the VHDL port size.
Enumerated types	Character array (string) that contains the MATLAB representation of a VHDL label or character literal. For example, the label <code>high</code> converts to <code>'high'</code> and the character literal <code>'c'</code> converts to <code>''c''</code> .	Cell array of strings with each element equal to a label for the defined enumerated type. Each element is the MATLAB representation of a VHDL label or character literal. For example, the vector <code>(one, '2', three)</code> converts to the column vector <code>['one'; ''2''; 'three']</code> . A user-defined enumerated type that contains only character literals, and then converts to a vector or array of characters as indicated for the types <code>STD_LOGIC_VECTOR</code> , <code>STD_ULOGIC_VECTOR</code> , <code>BIT_VECTOR</code> , <code>SIGNED</code> , and <code>UNSIGNED</code> .

The following table summarizes how the HDL Verifier software converts supported Verilog data types to MATLAB types. The software supports only scalar data types for Verilog.

Verilog-to-MATLAB Data Type Conversions

Verilog Types...	Converts to...
wire, reg	A character or a column vector of characters that matches the character literal for the desired logic states (bits).
integer	A 32-element column vector of characters that matches the character literal for the desired logic states (bits).

Array Indexing Differences Between MATLAB and HDL

In multidimensional arrays, the same underlying OS memory buffer maps to different elements in MATLAB and the HDL simulator (this mapping only reflects different ways the different languages offer for naming the elements of the same array). When you use both the `matlabtb` and `matlabcp` functions, be careful to assign and interpret values consistently in both applications.

In HDL, a multidimensional array declared as:

```
type matrix_2x3x4 is array (0 to 1, 4 downto 2) of std_logic_vector(8 downto 5);
```

has a memory layout as follows:

```
bit   01 02 03 04   05 06 07 08   09 10 11 12   13 14 15 16   17 18 19 20   21 22 23 24
-
dim1  0  0  0  0   0  0  0  0   0  0  0  0   1  1  1  1   1  1  1  1   1  1  1  1
dim2  4  4  4  4   3  3  3  3   2  2  2  2   4  4  4  4   3  3  3  3   2  2  2  2
dim3  8  7  6  5   8  7  6  5   8  7  6  5   8  7  6  5   8  7  6  5   8  7  6  5
```

This same layout corresponds to the following MATLAB 4x3x2 matrix:

```
bit   01 02 03 04   05 06 07 08   09 10 11 12   13 14 15 16   17 18 19 20   21 22 23 24
-
dim1  1  2  3  4   1  2  3  4   1  2  3  4   1  2  3  4   1  2  3  4   1  2  3  4
dim2  1  1  1  1   2  2  2  2   3  3  3  3   1  1  1  1   2  2  2  2   3  3  3  3
dim3  1  1  1  1   1  1  1  1   1  1  1  1   2  2  2  2   2  2  2  2   2  2  2  2
```

Therefore, if H is the HDL array and M is the MATLAB matrix, the following indexed values are the same:

```
b1  H(0,4,8) = M(1,1,1)
b2  H(0,4,7) = M(2,1,1)
b3  H(0,4,6) = M(3,1,1)
b4  H(0,4,5) = M(4,1,1)
b5  H(0,3,8) = M(1,2,1)
b6  H(0,3,7) = M(2,2,1)
```

```

...
b19 H(1,3,6) = M(3,2,2)
b20 H(1,3,5) = M(4,2,2)
b21 H(1,2,8) = M(1,3,2)
b22 H(1,2,7) = M(2,3,2)
b23 H(1,2,6) = M(3,3,2)
b24 H(1,2,5) = M(4,3,2)

```

You can extend this indexing to N-dimensions. In general, the dimensions—if numbered from left to right—are reversed. The right-most dimension in HDL corresponds to the left-most dimension in MATLAB.

Converting Data for Manipulation

Depending on how your simulation MATLAB function uses the data it receives from the HDL simulator, you may need to code the function to convert data to a different type before manipulating it. The following table lists circumstances under which you would require such conversions.

Required Data Conversions

If You Need the Function to...	Then...
Compute numeric data that is received as a type other than <code>double</code>	Use the <code>double</code> function to convert the data to type <code>double</code> before performing the computation. For example: <code>datas(inc+1) = double(idata);</code>
Convert a standard logic or bit vector to an unsigned integer or positive decimal	Use the <code>mv12dec</code> function to convert the data to an unsigned decimal value. For example: <code>uval = mv12dec(oport.val)</code> This example assumes the standard logic or bit vector is composed of the character literals '1' and '0' only. These are the only two values that can be converted to an integer equivalent. The <code>mv12dec</code> function converts the binary data that the MATLAB function receives from the entity's <code>osc_in</code> port to unsigned decimal values that MATLAB can compute.

If You Need the Function to...	Then...
	See <code>mv12dec</code> for more information on this function.
Convert a standard logic or bit vector to a negative decimal	<p>Use the following application of the <code>mv12dec</code> function to convert the data to a signed decimal value. For example:</p> <pre>suval = mv12dec(oport.val, true);</pre> <p>This example assumes the standard logic or bit vector is composed of the character literals '1' and '0' only. These are the only two values that can be converted to an integer equivalent.</p>

Examples

The following code excerpt illustrates data type conversion of data passed in to a callback:

```
InDelayLine(1) = InputScale * mv12dec(iport.osc_in',true);
```

This example tests port values of VHDL type `STD_LOGIC` and `STD_LOGIC_VECTOR` by using the `all` function as follows:

```
all(oport.val == '1' | oport.val
== '0')
```

This example returns `True` if all elements are '1' or '0'.

Converting Data for Return to the HDL Simulator

If your simulation MATLAB function needs to return data to the HDL simulator, you may first need to convert the data to a type supported by the HDL Verifier software. The following tables list circumstances under which such conversions are required for VHDL and Verilog.

Note: When data values are returned to the HDL simulator, the char array size must match the HDL type, including leading zeroes, if applicable. For example:

```
oport.signal = dec2mvl(2)
```

will only work if `signal` is a 2-bit type in HDL. If the HDL type is anything else, you *must* specify the second argument:

```
oport.signal = dec2mvl(2, N)
```

where N is the number of bits in the HDL data type.

VHDL Conversions for the HDL Simulator

To Return Data to an IN Port of Type...	Then...
STD_LOGIC, STD_ULONGIC, or BIT	<p>Declare the data as a character that matches the character literal for the desired logic state. For <code>STD_LOGIC</code> and <code>STD_ULONGIC</code>, the character can be 'U', 'X', '0', '1', 'Z', 'W', 'L', 'H', or '-'. For <code>BIT</code>, the character can be '0' or '1'. For example:</p> <pre>iport.s1 = 'X'; %STD_LOGIC iport.bit = '1'; %BIT</pre>
STD_LOGIC_VECTOR, STD_ULONGIC_VECTOR, BIT_VECTOR, SIGNED, or UNSIGNED	<p>Declare the data as a column vector or row vector of characters (as defined above) with one bit per character. For example:</p> <pre>iport.s1v = 'X10ZZ'; %STD_LOGIC_VECTOR iport.bitv = '10100'; %BIT_VECTOR iport.uns = dec2mvl(10,8); %UNSIGNED, 8 bits</pre>
Array of STD_LOGIC_VECTOR, STD_ULONGIC_VECTOR, BIT_VECTOR, SIGNED, or UNSIGNED	<p>Declare the data as an array of type character with a size that is equivalent to the VHDL port size. See “Array Indexing Differences Between MATLAB and HDL” on page 8-51.</p>
INTEGER or NATURAL	<p>Declare the data as an array of type <code>int32</code> with a size that is equivalent to the VHDL array size. Alternatively, convert the data to an array of type <code>int32</code> with the MATLAB <code>int32</code> function before returning it. Be sure to limit the data to values with the range of the VHDL type. If you want to, check the <code>right</code> and <code>left</code> fields of the <code>portinfo</code> structure. For example:</p> <pre>iport.int = int32(1:10)';</pre>
REAL	<p>Declare the data as an array of type <code>double</code> with a size that is equivalent to the VHDL port size. For example:</p> <pre>iport.dbl = ones(2,2);</pre>
TIME	<p>Declare a VHDL <code>TIME</code> value as time in seconds, using type <code>double</code>, or as an integer of simulator time increments, using type <code>int64</code>.</p>

To Return Data to an IN Port of Type...	Then...
	<p>You can use the two formats interchangeably and what you specify does not depend on the <code>hdldaemon 'time'</code> option (see <code>hdldaemon</code>), which applies to IN ports only. Declare an array of TIME values by using a MATLAB array of identical size and shape. All elements of a given port are restricted to time in seconds (type <code>double</code>) or simulator increments (type <code>int64</code>), but otherwise you can mix the formats. For example:</p> <pre> iport.t1 = int64(1:10)'; %Simulator time %increments iport.t2 = 1e-9; %1 nsec </pre>
Enumerated types	<p>Declare the data as a string for scalar ports or a cell array of strings for array ports with each element equal to a label for the defined enumerated type. The <code>'label'</code> field of the <code>portinfo</code> structure lists all valid labels (see “Gaining Access to and Applying Port Information” on page 8-35). Except for character literals, labels are not case sensitive. In general, you should specify character literals completely, including the single quotes, as in the first example shown here. .</p> <pre> iport.char = {'A', 'B'}; %Character %literal iport.undef = 'mylabel'; %User-defined label </pre>
Character array for standard logic or bit representation	<p>Use the <code>dec2mvl</code> function to convert the integer. For example:</p> <pre> oport.slva =dec2mvl([23 99],8)'; </pre> <p>This example converts two integers to a 2-element array of standard logic vectors consisting of 8 bits.</p>

Verilog Conversions for the HDL Simulator

To Return Data to an input Port of Type...	Then...
reg, wire	<p>Declare the data as a character or a column vector of characters that matches the character literal for the desired logic state. For example:</p> <pre> iport.bit = '1'; </pre>

To Return Data to an input Port of Type...	Then...
integer	Declare the data as a 32-element column vector of characters (as defined above) with one bit per character.

Simulation Timescales

In this section...

“Overview to the Representation of Simulation Time” on page 8-57

“Defining the Simulink and HDL Simulator Timing Relationship” on page 8-58

“Setting the Timing Mode with HDL Verifier” on page 8-58

“Relative Timing Mode” on page 8-60

“Absolute Timing Mode” on page 8-65

“Timing Mode Usage Considerations” on page 8-67

“Setting HDL Cosimulation Block Port Sample Times” on page 8-69

Overview to the Representation of Simulation Time

The representation of simulation time differs significantly between the HDL simulator and Simulink. Each application has its own timing engine and the verification software must synchronize the simulation times between the two.

In the HDL simulator, the unit of simulation time is referred to as a *tick*. The duration of a tick is defined by the HDL simulator *resolution limit*. The default resolution limit is 1 ns, but may vary depending on the simulator.

- **ModelSim Users:**

To determine the current ModelSim resolution limit, enter `echo $resolution` or `report simulator state` at the ModelSim prompt. You can override the default resolution limit by specifying the `-t` option on the ModelSim command line, or by selecting a different Simulator Resolution in the ModelSim Simulate dialog box. Available resolutions in ModelSim are 1x, 10x, or 100x in units of fs, ps, ns, us, ms, or sec. See the ModelSim documentation for further information.

- **Incisive Users:**

To determine the current HDL simulator resolution limit, enter `echo $timescale` at the HDL simulator prompt. See the HDL simulator documentation for further information.

Simulink maintains simulation time as a double-precision value scaled to seconds. This representation accommodates modeling of both continuous and discrete systems.

The relationship between Simulink and the HDL simulator timing affects the following aspects of simulation:

- Total simulation time
- Input port sample times
- Output port sample times
- Clock periods

During a simulation run, Simulink communicates the current simulation time to the HDL simulator at each intermediate step. (An intermediate step corresponds to a Simulink sample time hit. Upon each intermediate step, new values are applied at input ports, or output ports are sampled.)

To bring the HDL simulator up-to-date with Simulink during cosimulation, you must convert sampled Simulink time to HDL simulator time (ticks) and allow the HDL simulator to run for the computed number of ticks.

Defining the Simulink and HDL Simulator Timing Relationship

The differences in the representation of simulation time can be reconciled in one of two ways using the HDL Verifier interface:

- By defining the timing relationship manually (with **Timescales** pane)

When you define the relationship manually, you determine how many femtoseconds, picoseconds, nanoseconds, microseconds, milliseconds, seconds, or ticks in the HDL simulator represent 1 second in Simulink.

- By allowing HDL Verifier to define the timescale (with **Timescales** pane)

When you allow the software to define the timing relationship, it attempts to set the timescale factor between the HDL simulator and Simulink to be as close as possible to 1 second in the HDL simulator = 1 second in Simulink. If this setting is not possible, HDL Verifier attempts to set the signal rate on the Simulink model port to the lowest possible number of HDL simulator ticks.

Setting the Timing Mode with HDL Verifier

The **Timescales** pane of the HDL `Cosimulation` block parameters dialog box defines a correspondence between one second of Simulink time and some quantity of HDL

simulator time. This quantity of HDL simulator time can be expressed in one of the following ways:

- In *relative* terms (i.e., as some number of HDL simulator ticks). In this case, the cosimulation is said to operate in *relative timing mode*. The HDL Cosimulation block defaults to relative timing mode for cosimulation. For more on relative timing mode, see “Relative Timing Mode” on page 8-60.
- In *absolute* units (such as milliseconds or nanoseconds). In this case, the cosimulation is said to operate in *absolute timing mode*. For more on absolute timing mode, see “Absolute Timing Mode” on page 8-65.

The **Timescales** pane lets you choose an optimal timing relationship between Simulink and the HDL simulator, either by entering the HDL simulator equivalent or by letting HDL Verifier calculate a timescale for you.

You can choose to have HDL Verifier calculate a timescale while you are setting the parameters on the block dialog by clicking the **Timescale** option then clicking **Determine Timescale Now** or you can have HDL Verifier calculate the timescale when simulation begins by selecting **Automatically determine timescale at start of simulation**.

The next figure shows the default settings of the **Timescales** pane (example shown is for use with ModelSim).

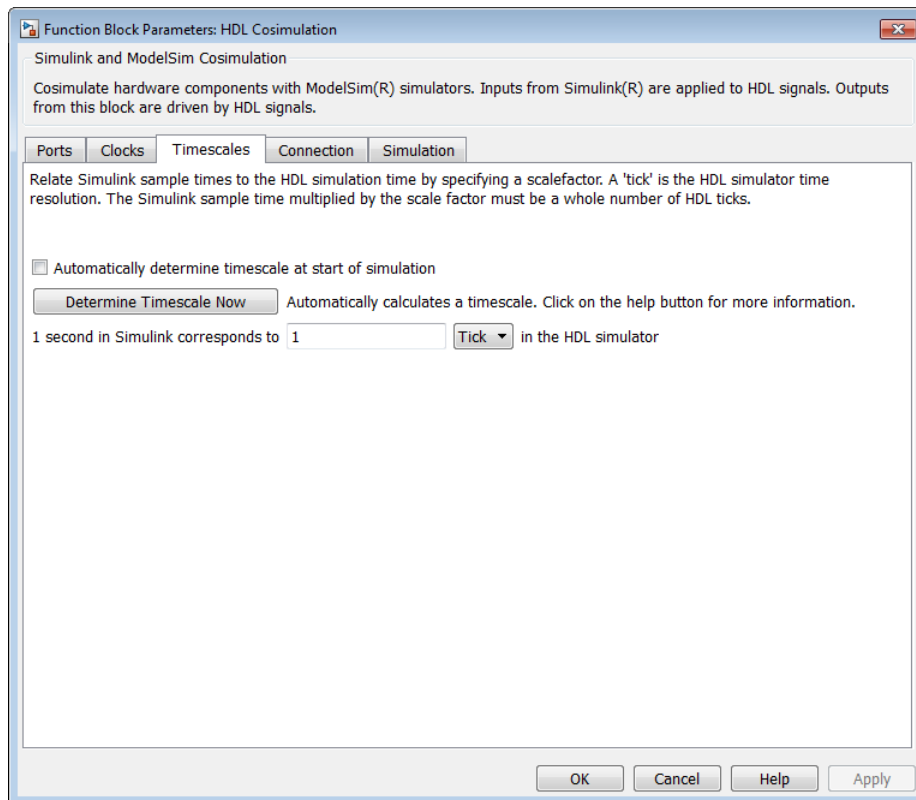

For instructions on setting the timing mode either manually or with the **Timescales** dialog box, see the **Timescales** pane in the **HDL Cosimulation** block reference.

Relative Timing Mode

Relative timing mode defines the following one-to-one correspondence between simulation time in Simulink and the HDL simulator:

One second in Simulink corresponds to *N ticks* in the HDL simulator, where N is a scale factor.

This correspondence holds regardless of the HDL simulator timing resolution.

The following pseudocode shows how Simulink time units are converted to HDL simulator ticks:

$$\text{InTicks} = N * \text{tInSecs}$$

where `InTicks` is the HDL simulator time in ticks, `tInSecs` is the Simulink time in seconds, and `N` is a scale factor.

Operation of Relative Timing Mode

The HDL `Cosimulation` block defaults to relative timing mode, with a scale factor of 1. Thus, 1 Simulink second corresponds to 1 tick in the HDL simulator. In the default case:

- If the total simulation time in Simulink is specified as `N` seconds, then the HDL simulation will run for exactly `N` ticks (i.e., `N` ns at the default resolution limit).
- Similarly, if Simulink computes the sample time of an HDL `Cosimulation` block input port as T_{si} seconds, new values will be deposited on the HDL input port at exact multiples of T_{si} ticks. If an output port has an explicitly specified sample time of T_{so} seconds, values will be read from the HDL simulator at multiples of T_{so} ticks.

Relative Timing Mode Example

To understand how relative timing mode operates, review cosimulation results from the following example model.

For Use with ModelSim

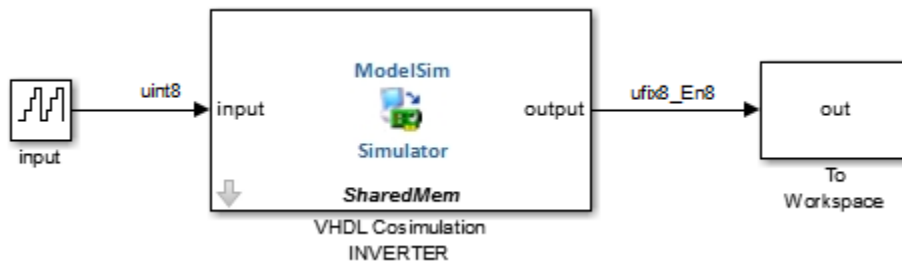

The model contains an HDL `Cosimulation` block (labeled VHDL Cosimulation INVERTER) simulating an 8-bit inverter that is enabled by an explicit clock. The inverter has a single input and a single output. The following sample shows VHDL code for the inverter:

```
LIBRARY ieee;
```

```
USE ieee.std_logic_1164.ALL;
ENTITY inverter IS PORT (

    inport : IN  std_logic_vector := "11111111";
    output: OUT std_logic_vector := "00000000";
    clk:IN  std_logic
);
END inverter;

LIBRARY ieee;
USE ieee.std_logic_1164.ALL;

ARCHITECTURE behavioral OF inverter IS
BEGIN
    PROCESS(clk)
    BEGIN
        IF (clk'EVENT AND clk = '1') THEN
            output <= NOT inport;
        END IF;
    END PROCESS;
END behavioral;
```

A cosimulation of this model might have the following settings:

- Simulation parameters in Simulink:
 - **Timescales** parameters: default (relative timing with a scale factor of 1)
 - Total simulation time: 60 s
 - Input port (/inverter/inport) sample time: 24 s
 - Output port (/inverter/output) sample time: 12 s
 - Clock (inverter/clk) period: 10 s
- ModelSim resolution limit: 1 ns

The next figure shows the ModelSim **wave** window after a cosimulation run of the example Simulink model for 60 ns. The **wave** window shows that ModelSim simulated for 60 ticks (60 ns). The inputs change at multiples of 24 ns and the outputs are read from ModelSim at multiples of 12 ns. The clock is driven low and high at intervals of 5 ns.

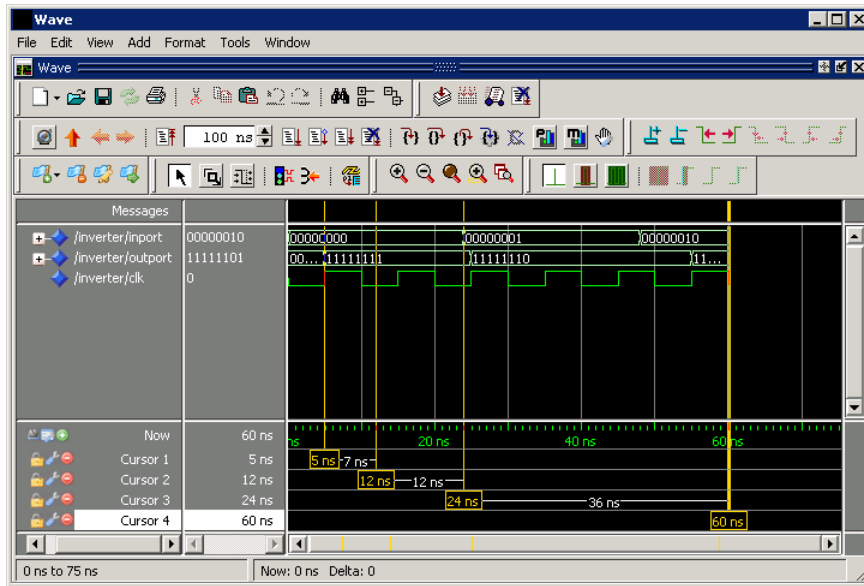

Now consider a cosimulation of the same model, this time configured with a scale factor of 100 in the **Timescales** pane.

The ModelSim **wave** window in the next figure shows that Simulink port and clock times were scaled by a factor of 100 during simulation. ModelSim simulated for 6 microseconds ($60 * 100$ ns). The inputs change at multiples of $24 * 100$ ns and outputs are read from ModelSim at multiples of $12 * 100$ ns. The clock is driven low and high at intervals of 500 ns.

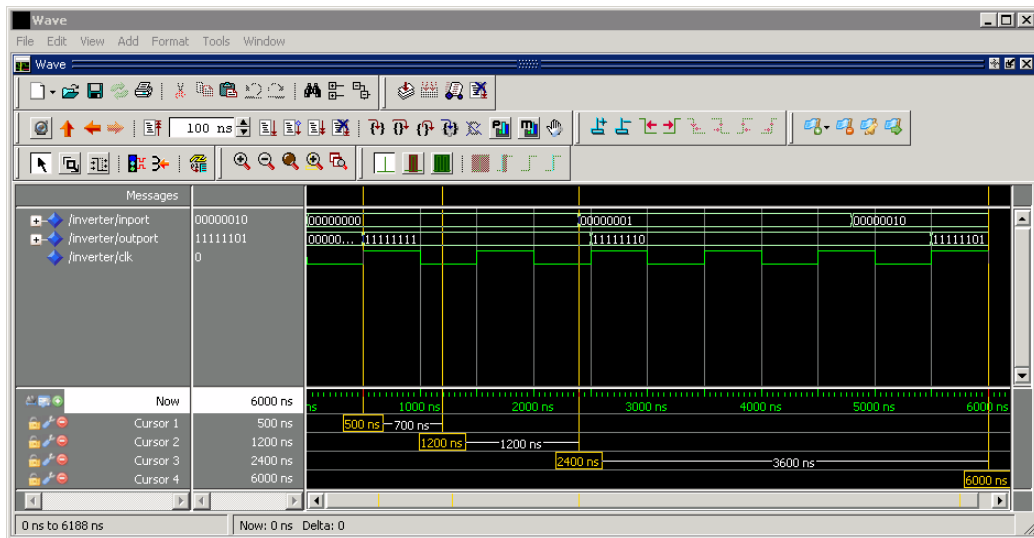

For Use with Incisive

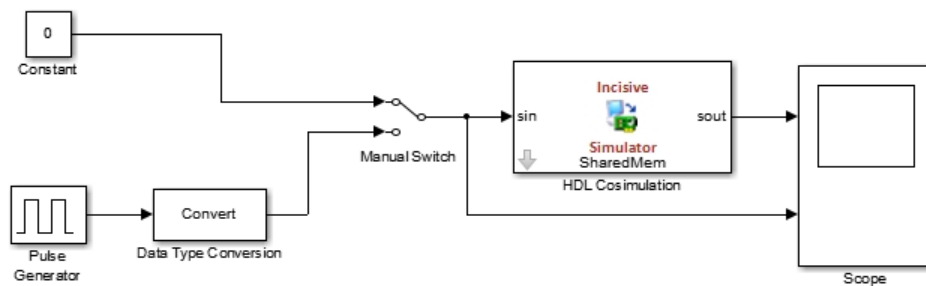

The model contains an HDL_Cosimulation block (labeled HDL_Cosimulation1) simulating an 8-bit inverter that is enabled by an explicit clock. The inverter has a single input and a single output. The following code excerpt lists the Verilog code for the inverter:

```
module inverter_clock_v1(sin, sout,clk);

input [7:0] sin;
output [7:0] sout;
input clk;
```

```

reg [7:0] sout;

always @(posedge clk)
    sout <= ! (sin);
endmodule

```

A cosimulation of this model might have the following settings:

- Simulation parameters in Simulink:
 - **Timescales** parameters: 1 Simulink second = 10 HDL simulator ticks
 - Total simulation time: 30 s
 - Input port (`inverter_clock_v1.sin`) sample time: N/A
 - Output port (`inverter_clock_v1.sout`) sample time: 1 s
 - Clock (`inverter_clock_v1.clk`) period: 5 s
- HDL simulator resolution limit: 1 ns

The previous example was excerpted from the HDL Verifier Inverter tutorial. For more information, see HDL Verifier demos.

Absolute Timing Mode

Absolute timing mode lets you define the timing relationship between Simulink and the HDL simulator in terms of absolute time units and a scale factor:

One second in Simulink corresponds to $(N * Tu)$ seconds in the HDL simulator, where Tu is an absolute time unit (for example, ms, ns, etc.) and N is a scale factor.

In absolute timing mode, all sample times and clock periods in Simulink are quantized to HDL simulator ticks. The following pseudocode illustrates the conversion:

```
tInTicks = tInSecs * (tScale / tRL)
```

where:

- `tInTicks` is the HDL simulator time in ticks.
- `tInSecs` is the Simulink time in seconds.
- `tScale` is the timescale setting (unit and scale factor) chosen in the **Timescales** pane of the HDL **Cosimulation** block.

- t_{RL} is the HDL simulator resolution limit.

For example, given a **Timescales** pane setting of 1 s and an HDL simulator resolution limit of 1 ns, an output port sample time of 12 ns would be converted to ticks as follows:

$$t_{InTicks} = 12\text{ns} * (1\text{s} / 1\text{ns}) = 12$$

Operation of Absolute Timing Mode

To configure the Timescales parameters for absolute timing mode, you select a unit of absolute time that corresponds to a Simulink second, rather than selecting `TICK`.

Absolute Timing Mode Example

To understand the operation of absolute timing mode, you will again consider the example model discussed in “Operation of Relative Timing Mode” on page 8-61. Suppose that the model is reconfigured as follows:

- Simulation parameters in Simulink:
 - **Timescale** parameters: 1 s of Simulink time corresponds to 1 s of HDL simulator time.
 - Total simulation time: $60\text{e-}9$ s (60ns)
 - Input port (`/inverter/inport`) sample time: $24\text{e-}9$ s (24 ns)
 - Output port (`/inverter/outport`) sample time: $12\text{e-}9$ s (12 ns)
 - Clock (`inverter/clock`) period: $10\text{e-}9$ s (10 ns)
- HDL simulator resolution limit: 1 ns

Given these simulation parameters, the Simulink software will cosimulate with the HDL simulator for 60 ns, during which Simulink will sample inputs at intervals of 24 ns, update outputs at intervals of 12 ns, and drive clocks at intervals of 10 ns.

The following figure shows a ModelSim **wave** window after a cosimulation run.

Noninteger Time Periods

When using noninteger time periods, the HDL simulator cannot represent such an infinitely repeating value. So the simulator truncates the time period, but it does so differently than how Simulink truncates the value, and the two time periods no longer match up.

The following example demonstrates how to set the timing relationship in the following scenario: you want to use a sample period of $\frac{1}{3\text{Hz}}$ in Simulink, which corresponds to a noninteger time period.

The key idea here is that you must always be able to relate a Simulink time with an HDL tick. The HDL tick is the finest time slice the HDL simulator recognizes; for ModelSim, the default tick is 1 ns, but it can be made as precise as 1 fs.

However, a 3 Hz signal actually has a period of 333.3333333333... ms, which is not a valid tick period for the HDL simulator. The HDL simulator will truncate such numbers. But Simulink does not make the same decision; thus, for cosimulation where you are trying to keep two independent simulators in synchronization, you should not assume anything. Instead you have to decide whether it is convenient to truncate or round the number.

Therefore, the solution is to "snap" either the Simulink sample time or the HDL sample time (via the timescale) to valid numbers. There are infinite possibilities, but here are some possible ways to perform a snap:

- Change Simulink sample times from 1/3 sec to 0.33333 sec and set the cosimulation block timescale to '1 second in Simulink = 1 second in the HDL simulator'. If you are specifying a clock in the HDL **Cosimulation** block **Clocks** pane, its period should be 0.33333 sec.
- Keep Simulink sample times at 1/3 sec. and 1 second in Simulink = 6 ticks in the HDL simulator.
 - If you are specifying a clock in the HDL **Cosimulation** block **Clocks** pane, its period should be 1/3. Briefly, this specification tells Simulink to make each Simulink sample time correspond to every $(1/3*6) = 2$ ticks, regardless of the HDL time resolution.
 - If your default HDL simulator resolution is 1 ns, that means your HDL sample times are every 2 ns. This sample time will work in a way so that for every Simulink sample time there is a corresponding HDL sample time.

- However, Simulink thinks in terms of 1/3 sec periods and the HDL in terms of 2 ns periods. Thus, you could get confused during debug. If you want this to match the real period (such as to 5 places, i.e. 333.33 ms), you can follow the next option listed.
- Keep Simulink sample times at 1/3 sec and 1 second in Simulink = 0.99999e9 ticks in the HDL simulator. If you are specifying a clock in the HDL **Cosimulation** block **Clocks** pane, its period should be 1/3.

Setting HDL Cosimulation Block Port Sample Times

In general, Simulink handles the sample time for the ports of an HDL **Cosimulation** block as follows:

- If an input port is connected to a signal that has an explicit sample time, based on forward propagation, Simulink applies that rate to that input port.
- If an input port is connected to a signal that *does not have* an explicit sample time, Simulink assigns a sample time that is equal to the least common multiple (LCM) of all identified input port sample times for the model.
- After Simulink sets the input port sample periods, it applies user-specified output sample times to all output ports. Sample times must be explicitly defined for all output ports.

If you are developing a model for cosimulation in *relative* timing mode, consider the following sample time guideline:

Specify the output sample time for an HDL **Cosimulation** block as an integer multiple of the resolution limit defined in the HDL simulator. Use the HDL simulator command `report simulator state` to check the resolution limit of the loaded model. If the HDL simulator resolution limit is 1 ns and you specify a block's output sample time as 20, Simulink interacts with the HDL simulator every 20 ns.

Clock, Reset, and Enable Signals

In this section...

“Driving Clocks, Resets, and Enables” on page 8-70

“Adding Signals Using Simulink Blocks” on page 8-70

“Creating Optional Clocks with the Clocks Pane of the HDL Cosimulation Block” on page 8-71

“Driving Signals by Adding Force Commands” on page 8-74

Driving Clocks, Resets, and Enables

You can create rising-edge or falling-edge clocks, resets, or clock enable signals that apply internal stimuli to your model under cosimulation. You can add these signals by:

- “Adding Signals Using Simulink Blocks” on page 8-70
- “Creating Optional Clocks with the Clocks Pane of the HDL Cosimulation Block” on page 8-71
- “Driving Signals by Adding Force Commands” on page 8-74
- Implementing these signals directly in HDL code. If your model is part of a much larger HDL design, you (or the larger model designer) may choose to implement these signals in the Verilog or VHDL files. However, that implementation exceeds the scope of this documentation; see an HDL reference for more information.

Adding Signals Using Simulink Blocks

Add rising-edge or falling-edge clocks, resets, or clock enable signals to your Simulink model using Simulink blocks. See the Simulink User Guide and Reference for instructions on adding blocks to a model.

In the following example excerpt, the shaded area shows a clock, a reset, and a clock enable signal as input to a multiple HDL `Cosimulation` block model. These signals are created using two Simulink data type conversion blocks and a constant source block, which connect to the HDL Cosimulation block labeled "Manchester Receiver Subsystem".

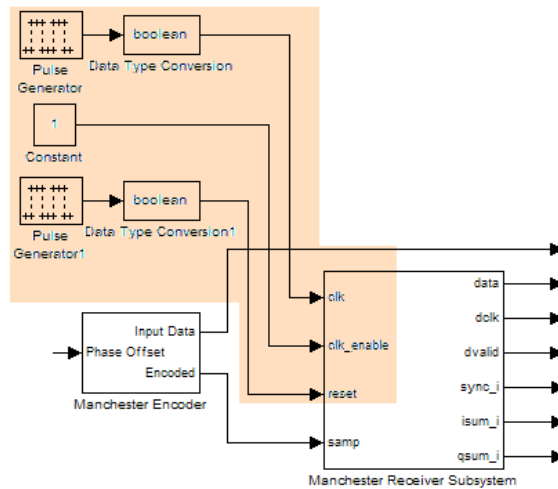

Creating Optional Clocks with the Clocks Pane of the HDL Cosimulation Block

Note: For ModelSim and Incisive Users Only

When you specify a clock in your block definition, Simulink creates a rising-edge or falling-edge clock that drives the specified HDL signal.

Simulink attempts to create a clock that has a 50% duty cycle and a predefined phase that is inverted for the falling edge case. If applicable, Simulink degrades the duty cycle to accommodate odd Simulink sample times, with a worst case duty cycle of 66% for a sample time of $T=3$.

Whether you have configured the **Timescales** pane for relative timing mode or absolute timing mode, the following restrictions apply to clock periods:

- If you specify an explicit clock period, you must enter a sample time equal to or greater than 2 resolution units (ticks).

- If the clock period (whether explicitly specified or defaulted) is not an even integer, Simulink cannot create a 50% duty cycle, and therefore the HDL Verifier software creates the falling edge at

$$\text{clockperiod} / 2$$

(rounded down to the nearest integer).

For more information on calculating relative and absolute timing modes, see “Defining the Simulink and HDL Simulator Timing Relationship” on page 8-58.

The following figure shows a timing diagram that includes rising and falling edge clocks with a Simulink sample time of $T=10$ and an HDL simulator resolution limit of 1 ns. The figure also shows that given those timing parameters, the clock duty cycle is 50%.

Rising Edge Clock

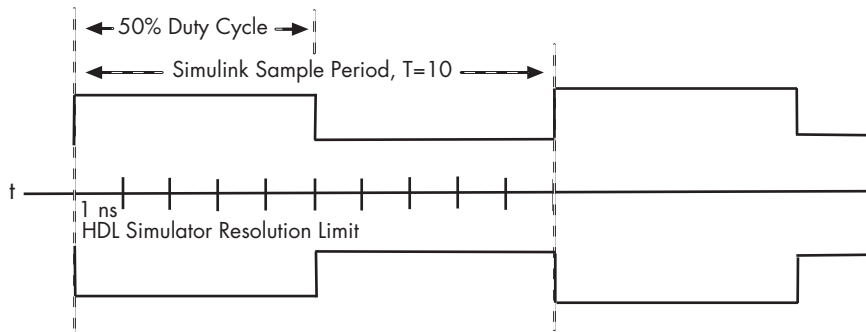

Falling Edge Clock

To create clocks, perform the following steps:

- 1 In the HDL simulator, determine the clock signal path names you plan to define in your block. To do so, you can use the same method explained for determining the signal path names for ports in step 1 of “Map HDL Signals to Block Ports” on page 4-17.
- 2 Select the **Clocks** tab of the Block Parameters dialog box. Simulink displays the dialog box as shown in the next figure (example shown for use with Incisive).

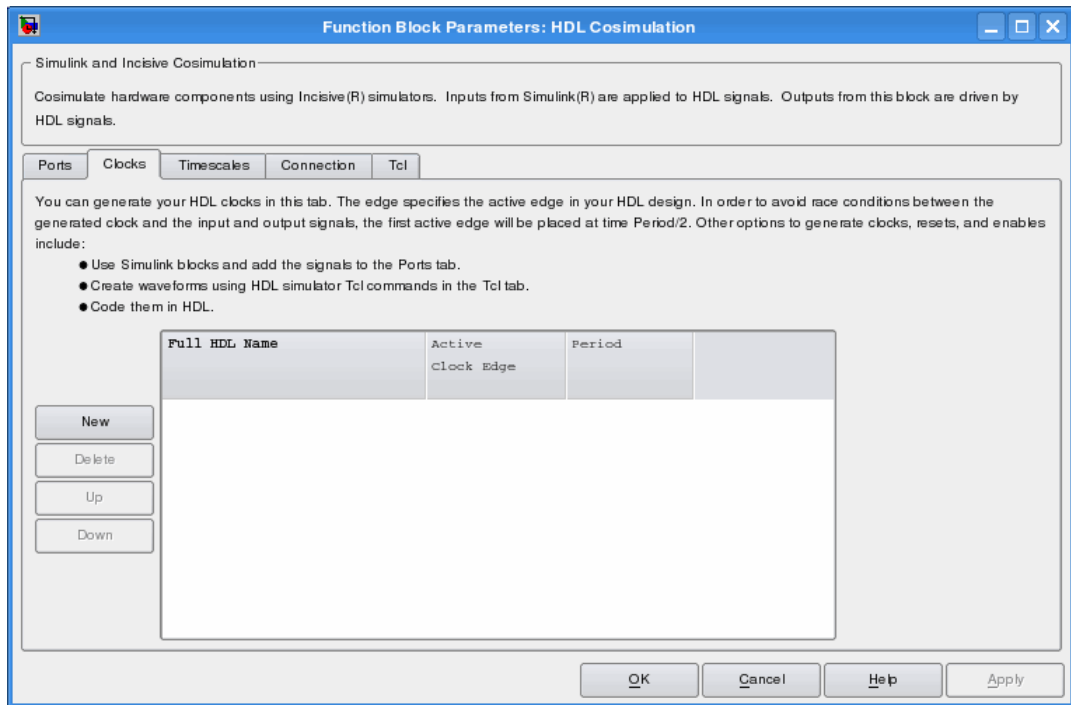

- 3 Click **New** to add a new clock signal.
- 4 Edit the clock signal path name directly in the table under the **Full HDL Name** column by double-clicking the default clock signal name (`/top/c1k`). Then, specify your new clock using HDL simulator path name syntax. See “Specify HDL Signal/Port and Module Paths for Cosimulation” on page 4-18.

The HDL simulator does not support vectored signals in the **Clocks** pane. Signals must be logic types with 1 and 0 values.

- 5 To specify whether the clock generates a rising-edge or falling edge signal, select **Rising** or **Falling** from the **Active Clock Edge** list.
- 6 The **Period** field specifies the clock period. Accept the default (2), or override it by entering the desired clock period explicitly by double-clicking in the **Period** field.

Specify the **Period** field as an even integer, with a minimum value of 2.

- 7 When you have finished editing clock signals, click **Apply** to register your changes with Simulink.

The following dialog box defines the rising-edge clock `clk` for the HDL Cosimulation block, with a default period of 2 (example shown for use with Incisive).

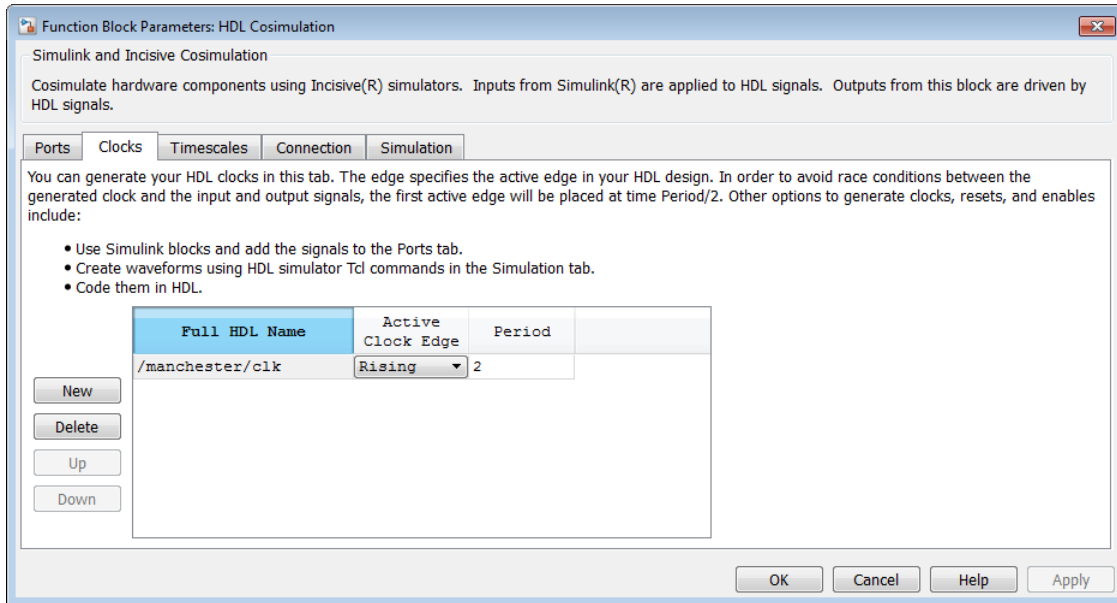

Driving Signals by Adding Force Commands

You can drive clocks, resets, and enable signals in either of two ways:

- By adding force commands to the **Simulation** pane (ModelSim and Incisive users only)
- By driving signals with one of the HDL Verifier HDL simulator launch commands (`vsim` or `nclaunch`) and the force command

Examples: force Command entered in HDL Cosimulation block Simulation Pane

The following is an example of entering force commands in the **Simulation** pane of the HDL Cosimulation block for use with Incisive:

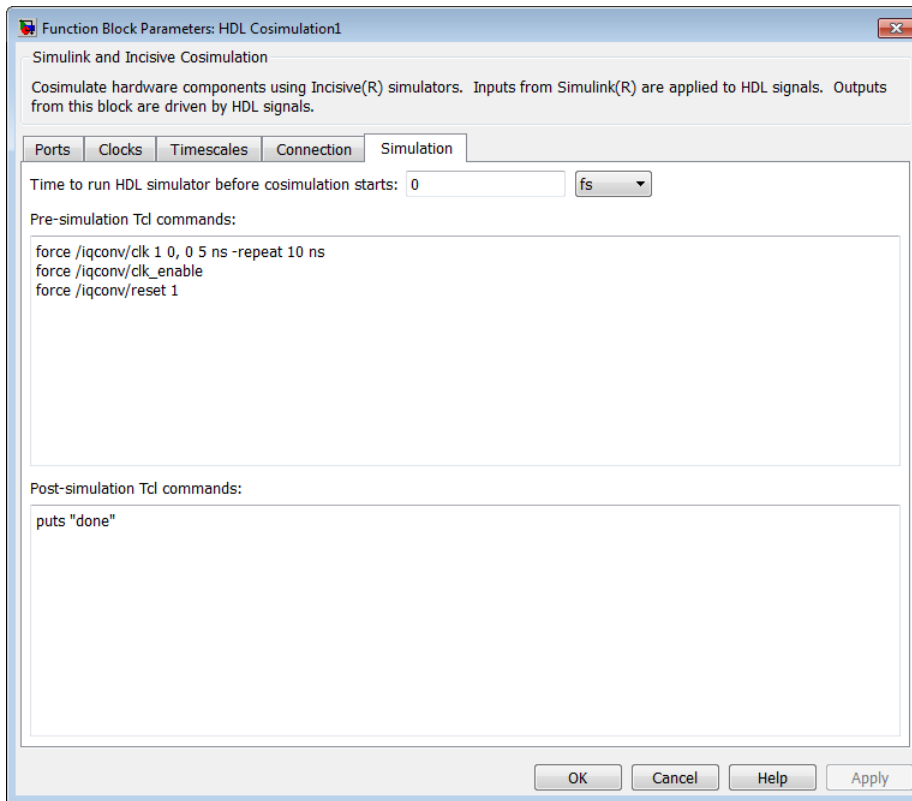

The following is an example of entering force commands in the **Simulation** pane of the HDL Cosimulation block for use with ModelSim:

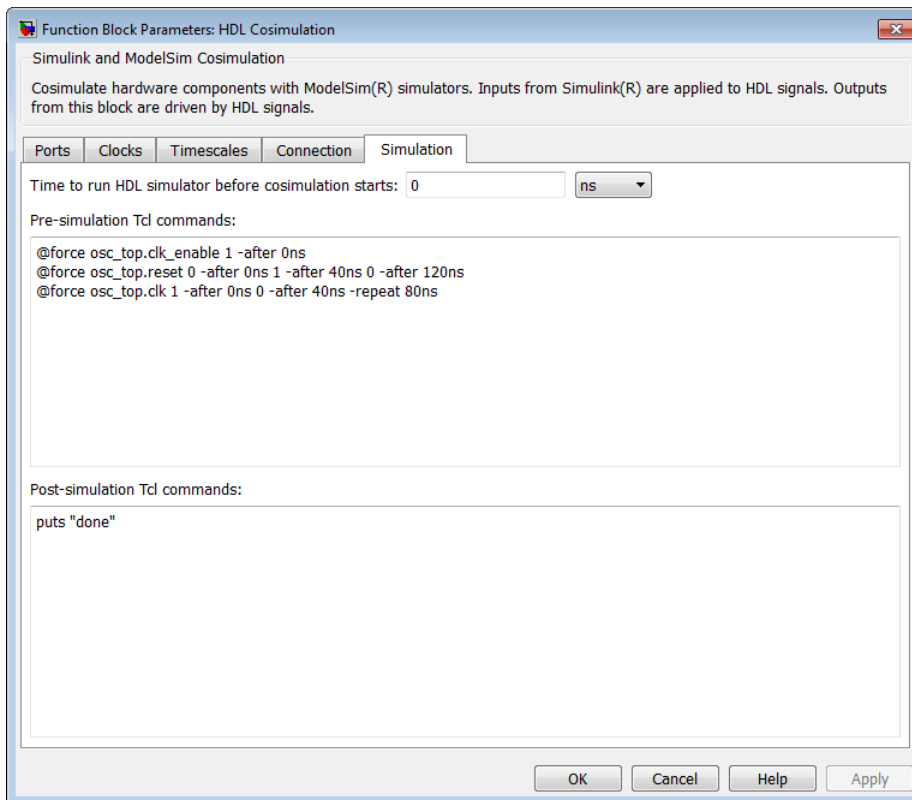

Examples: force Command used with HDL Verifier HDL Simulator Launch Command

`vsim` function and `force` command (ModelSim users):

```
vsim('tclstart', {'force /iqconv/clk 1 0, 0 5 ns -repeat 10 ns ',
                 'force /iqconv/clk_enable 1', 'force /iqconv/reset 1'});
```

`nclaunch` function and `force` command (Incisive users):

```
nclaunch('tclstart', ['-input "{@force osc_top.clk_enable 1 -after 0ns}"',
                     '-input "{@force osc_top.reset 0 -after 0ns 1 -after 40ns 0 -after 120ns}"',
                     '-input "{@force osc_top.clk 1 -after 0ns 0 -after 40ns -repeat 80ns}"}');
```

TCP/IP Socket Ports

When you specify a TCP/IP socket port, choose an available port or service name (alias). If you are uncertain what port is available, use `hdldaemon('socket', 0)` to get an available port. If you choose a port that is already in use, you will get an error message.

When you set up communication between computers, you must specify the host name as well as the port name on the client side.

Examples:

```
<port-num>           4449
<port-alias>        matlabservice
<host>:<port-num>    compa:4449
<port-alias>@<host-ia>  matlabservice@123.34.55.23
```

Note that TCP/IP port filtering on either the client or server side can cause the HDL Verifier interface to fail to make a connection. If you get an error, remove filtering (see OS user guide), or try a different port.

FPGA-in-the-Loop

About FPGA-in-the-Loop Simulation

FPGA-in-the-Loop Simulation

In this section...
“What is FPGA-in-the-Loop Simulation?” on page 9-2
“What You Need To Know” on page 9-4

What is FPGA-in-the-Loop Simulation?

- “Overview” on page 9-2
- “Communication Channel” on page 9-4
- “Downstream Workflow Automation” on page 9-4

Overview

FPGA-in-the-loop (FIL) simulation provides the capability to use Simulink or MATLAB software for testing designs in real hardware for any existing HDL code. The HDL code can be either manually written or software generated from a model subsystem.

You must have HDL code to perform FIL simulation. There are two FIL workflows:

- You have existing HDL code (FIL wizard).

Note: The FIL wizard uses any synthesizable HDL code including code automatically generated from Simulink models by HDL Coder software

- You have MATLAB code or a Simulink model *and* an HDL Coder license (HDL workflow advisor).

Note: When you use FIL in the Workflow Advisor, HDL Coder uses the loaded design to create the HDL code.

No matter which workflow you choose, FIL performs the following processes when it creates the block or System object:

- Generates a FIL block or FIL System object that represents the HDL code
- Provides synthesis, logical mapping, place-and-route (PAR), programming file generation, and communications channel.

- Loads the design onto an FPGA

All these capabilities are designed for a particular board and tailored to your RTL code.

As part of FIL simulation, the block or System object and your model or application:

- Transmits data from Simulink or MATLAB to the FPGA
- Receives data from the FPGA
- Exercises the design in a real environment

FIL Communications

The following figure demonstrates how HDL Verifier communicates between Simulink and the FPGA board using FIL simulation.

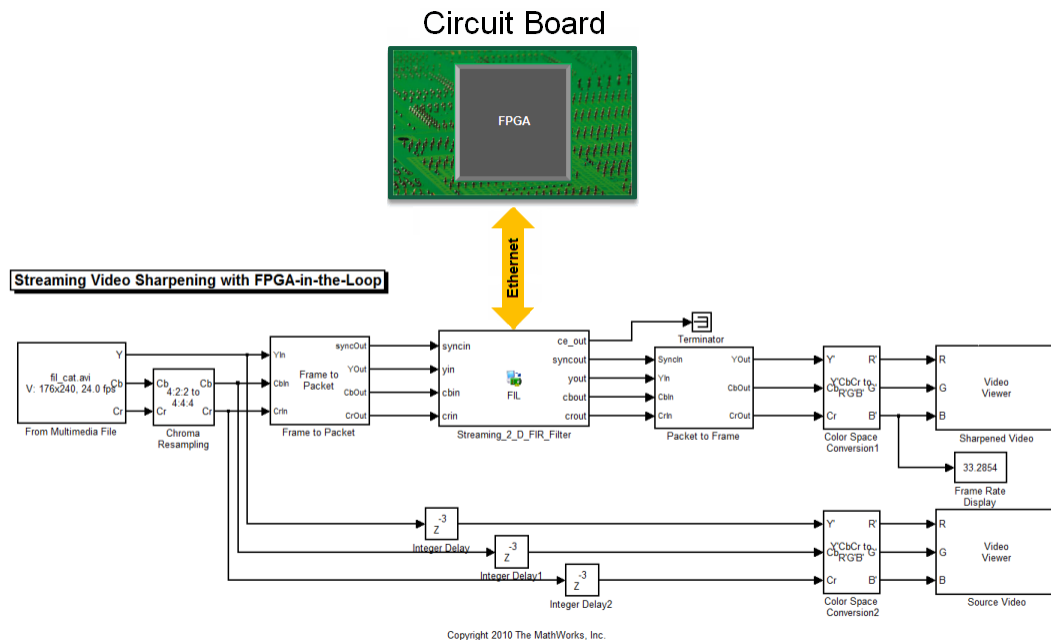

Note: HDL Verifier assumes that there is only one download cable connected to the host computer, and that the FPGA programming software can automatically detect this connection. If not, use FPGA programming software to program your FPGA with the correct options.

System-Level View

All DUT I/Os are routed to Simulink through the FIL communication logic.

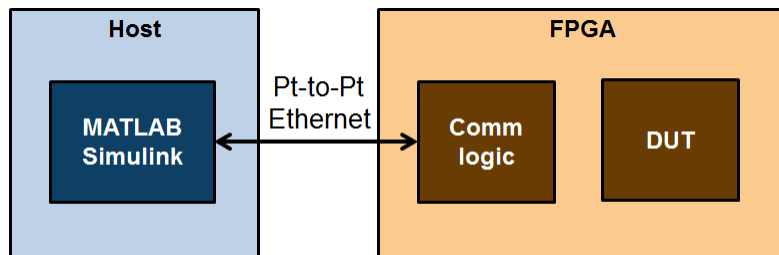

Communication Channel

FIL provides the communication channel for sending and receiving data between Simulink and the FPGA. This channel can be a JTAG, Ethernet, or PCI Express[®] connection. Communication between Simulink and the FPGA is strictly synchronized to provide a reliable verification environment.

Downstream Workflow Automation

To create the FIL programming file, the software performs the following tasks:

- Generates HDL code for the specified DUT and creates an ISE project.
- Along with your FPGA design software, synthesizes, maps, places and routes, and creates a programming file for the FPGA.
- Downloads the programming file to the FPGA on the development board through the normal configuration connection. Typically, that connection is a serial line over a USB cable (see the board user guide for how to make this connection).
 - For FIL simulation blocks, clicking **Load** on the FIL block mask initiates the programming file download.
 - For FIL simulation System objects, issuing the `programFPGA` method initiates the programming file download.

What You Need To Know

For FIL simulation, you must have the following items or information ready:

- For FIL wizard:
 - Provide HDL code (either manually written or software generated) for the design you intend to test.
 - Select HDL files and specify the top-level module name.
 - Review port settings and make sure the FIL wizard identified input and output signals and signal sizes as expected.
 - If you are using Simulink, provide a Simulink model ready to receive the generated FIL block.
- For HDL Workflow Advisor:

You can generate code and run FIL from any suitable Simulink model. Follow the workflow for **FPGA-in-the-Loop**. See “FIL Simulation with HDL Workflow Advisor for Simulink” on page 12-2. For MATLAB code, see the workflow described in “FIL Simulation with HDL Workflow Advisor for MATLAB” on page 12-10.

FIL Preparation

- “FPGA-in-the-Loop Simulation Workflows” on page 10-2
- “Download FPGA Board Support Package” on page 10-3
- “Set Up FPGA Design Software Tools” on page 10-7
- “Guided Hardware Setup” on page 10-8
- “Manual Hardware Setup” on page 10-15
- “Prepare DUT For FIL Interface Generation” on page 10-23

FPGA-in-the-Loop Simulation Workflows

You must have HDL code to perform FIL simulation. There are two FIL workflows:

- You have existing HDL code (FIL wizard).

Note: The FIL wizard uses any synthesizable HDL code including code automatically generated from Simulink models by HDL Coder software

- You have MATLAB code or a Simulink model *and* an HDL Coder license (HDL workflow advisor).

Note: When you use FIL in the Workflow Advisor, HDL Coder uses the loaded design to create the HDL code.

For either workflow, the first three steps are the same:

- 1 “Download FPGA Board Support Package” on page 10-3 or create custom board definition files for use with FIL (see “FPGA Board Customization” on page 15-2)
- 2 “Prepare DUT For FIL Interface Generation” on page 10-23
- 3 ffgdgdg“Set Up FPGA Design Software Tools” on page 10-7

For the next step, click the link for the workflow you are going to follow:

- If you have existing HDL code, select block or System object generation using the FIL wizard:
 - “Block Generation with the FIL Wizard” on page 11-2
 - “System Object Generation with the FIL Wizard” on page 11-12
- If you need the HDL workflow advisor to generate HDL code, select block or System object generation using HDL workflow advisor:
 - “FIL Simulation with HDL Workflow Advisor for Simulink” on page 12-2
 - “FIL Simulation with HDL Workflow Advisor for MATLAB” on page 12-10

Note: To use the HDL Coder HDL workflow advisor for Simulink to generate a FIL interface, you must have an HDL Coder license.

Download FPGA Board Support Package

In this section...

“HDL Verifier Support Packages for FPGA Boards” on page 10-3

“Install with Connection to Internet” on page 10-4

“Install Support Package Offline” on page 10-5

HDL Verifier Support Packages for FPGA Boards

The FPGA board support packages contain the definition files for all the supported boards for FPGA-in-the-loop (FIL) simulation. You can download any or all the FPGA board support packages. Before you can use FIL, download at least one of the FPGA board support packages or customize your own board definition file.

You can download FPGA board support packages from within the HDL workflow advisor, or the FIL wizard, by clicking **Launch Board Manager**, and selecting **Get More Boards**. Or, to customize a board definition file, see “FPGA Board Customization” on page 15-2. You can also install offline.

After you have downloaded an FPGA board support package, you can use “FPGA-in-the-Loop Simulation” on page 9-2.

Install with Connection to Internet

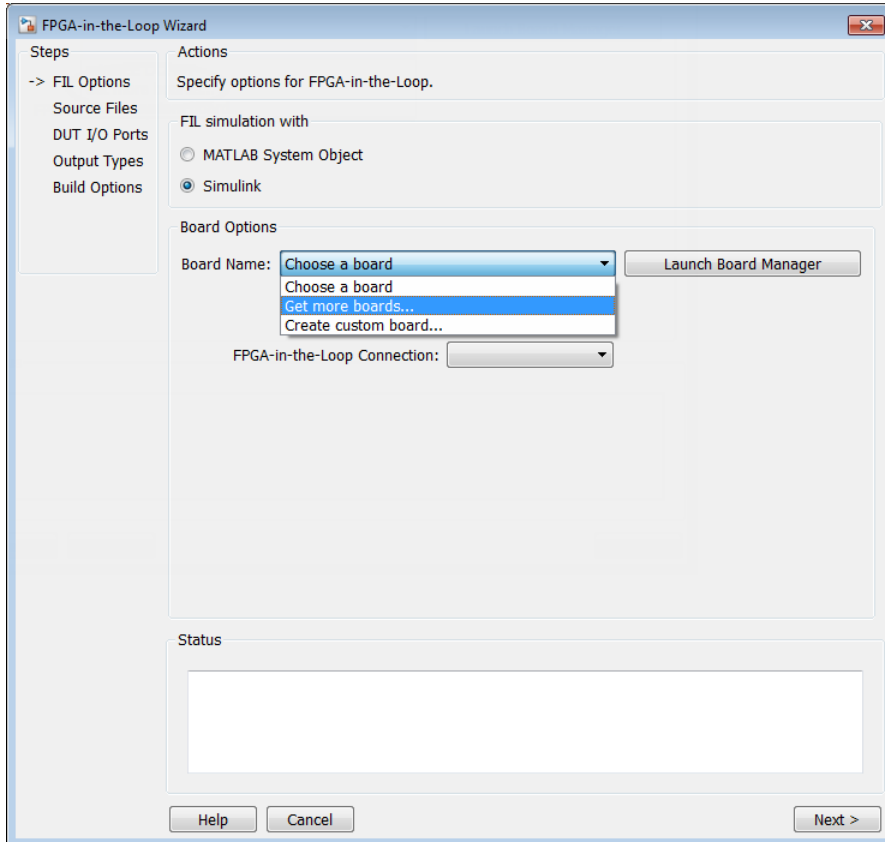

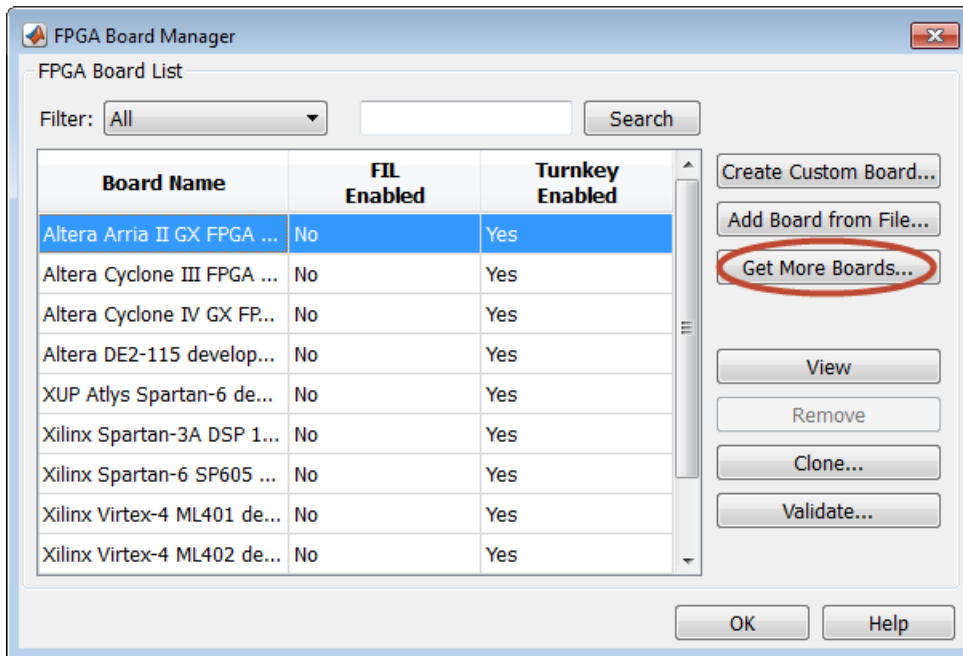

After you have downloaded an FPGA board support package, you can use “FPGA-in-the-Loop Simulation” on page 9-2.

Install Support Package Offline

To install the board support packages without an Internet connection, first download the packages on a computer that *does* have an Internet connection.

- 1 On the computer with the Internet connection, start MATLAB.
- 2 Select **Add-Ons > Get Hardware Support Packages**.
- 3 Select **Download from Internet**.
- 4 Select the board support package you want to download. Click **Next** and follow the installer prompts. The last screen displays where you can find the downloaded file.
- 5 Copy the downloaded file to a shared network drive or removable media, such as a USB drive.

Then, on the computer where you want to install the board support packages:

- 1 Copy the downloaded file to the host computer.
- 2 Start MATLAB.
- 3 Select **Add-Ons > Get Hardware Support Packages**.
- 4 Select **Install from folder**.
- 5 Specify the path to the folder where the downloaded files are located.
- 6 Click **Next**, and follow the installer prompts to install the board support package. If you do actually have an Internet connection, you are prompted to log in to your MathWorks® account.

Set Up FPGA Design Software Tools

In this section...

“Xilinx Software” on page 10-7

“Altera Software” on page 10-7

Xilinx Software

Set up your system environment for accessing Xilinx ISE or Vivado® from MATLAB with the function `hdlsetuptoolpath`. This function adds the required folders to the MATLAB search path using the Xilinx installation folder as its argument.

- Windows with ISE:

```
hdlsetuptoolpath...  
('ToolName', 'Xilinx ISE', 'ToolPath', 'C:\Xilinx\14.2\ISE_DS\ISE\bin\nt64')
```

This example assumes that the Xilinx ISE design suite is installed at `C:\Xilinx\14.2\ISE_DS\ISE\bin\nt64`.

- Linux with Vivado:

```
hdlsetuptoolpath...  
('ToolName', 'Xilinx Vivado', 'ToolPath', 'local/Xilinx/Vivado/bin')
```

This example assumes that the Xilinx Vivado software is installed at `local/Xilinx/Vivado/bin`.

Altera Software

Set up your system environment for accessing from MATLAB with the function `hdlsetuptoolpath`. For example:

```
hdlsetuptoolpath...  
('ToolName', 'Altera Quartus II', 'ToolPath', 'C:\Altera\12.0\quartus\bin64')
```

This example assumes that the Altera FPGA design software is installed at `C:\Altera\12.0\quartus\bin64`.

Guided Hardware Setup

In this section...

“Select Board and Interface for Use with FPGA-in-the-Loop” on page 10-8

“Connection Requirements” on page 10-8

“Connection Setup” on page 10-9

“Configure Network Card on Host” on page 10-13

“PCIe Driver Installation” on page 10-14

“Verify Setup” on page 10-14

“Open the Example” on page 10-14

Select Board and Interface for Use with FPGA-in-the-Loop

The guided hardware setup for FPGA boards you want to use with FPGA-in-the-loop (FIL) processing helps you get started with FIL more quickly. Before you run the guided setup, make sure you have all the required hardware ready and any required third-party tools already installed.

The guided setup starts automatically during support package download and installation. After the support package you selected is installed, you are prompted to select your board name and the interface you want to use with this board. You can select only interfaces supported by the FPGA board. A PCIe connection with FIL is not supported on Linux.

Note: You can rerun the target updater at any time by entering `targetupdater` at the MATLAB prompt.

Connection Requirements

Note: Do not connect or turn on the FPGA development board until you are prompted at a later step.

Ethernet

- FPGA development board
- USB-JTAG cable with installed vendor software (ISO, Vivado, or Quartus)
- Ethernet cable
- Dedicated Gigabit network interface card (NIC) or a USB 3.0 Gigabit Ethernet adapter dongle
- Power supply adapter (if the board requires one)

JTAG

- FPGA development board
- USB-JTAG cable with installed vendor software (ISO, Vivado, or Quartus)
- Power supply adapter (if the board requires one)

PCIe

HDL Verifier supports a PCIe connection for FIL with Windows 7 and Windows 8 operating systems only.

- FPGA development board
- USB-JTAG cable with installed vendor software (ISO, Vivado, or Quartus)
- A PCIe slot and available space on the motherboard
- Power supply adapter (if the board requires one)

Note: Do not connect or power the board until you are prompted at a later step.

Connection Setup**Ethernet**

- 1** Make sure that power remains off. You are prompted to turn the power on at a later step.
- 2** Connect the AC power cord to the power plug, and plug the power supply adapter cable into the FPGA development board.
- 3** Use the crossover Ethernet cable to connect the Ethernet connector on the FPGA development board directly to the Ethernet adapter on your computer.

- 4 Use the JTAG download cable to connect the FPGA development board to the computer.
- 5 Make sure that all the jumpers on the FPGA development board are in the factory default position.

JTAG

- 1 Make sure that power remains off. You are prompted to turn the power on at a later step.
- 2 Connect the AC power cord to the power plug, and plug the power supply adapter cable into the FPGA development board.
- 3 Use the JTAG download cable to connect the FPGA development board to the computer.
- 4 Make sure that all the jumpers on the FPGA development board are in the factory default position.

PCIe

- 1 Turn off the host computer.
- 2 Make sure that the board power switch is off during these setup steps.
- 3 Select the maximum number of PCIe lanes supported by the board. For details, refer to the user manual for the board.

Supported Board	PCIe Setup	Documentation
DSP Development Kit, Stratix® V Edition	Set the three switches (PCIE_PRSENT2nx1, x4, x8) in dip switch SW6 to ON. This setting selects 8-lane PCIe (default board setting).	https://www.altera.com/products/boards_and_kits/dev-kits/altera/kit-stratix-v-dsp.html
Cyclone® V GT FPGA Development Kit	Set the two switches(PCIE_x1, x4) in dip switch SW3 to ON. This setting selects 4-lane PCIe (default board setting).	https://www.altera.com/products/boards_and_kits/dev-kits/altera/kit-cyclone-v-gt.html

Supported Board	PCIe Setup	Documentation
Kintex [®] -7 KC705	Set jumper J32 so that it connects pins 5 and 6. This setting selects 8-lane PCIe (default board setting).	http://www.xilinx.com/products/boards-and-kits/ek-k7-kc705-g.html
Virtex [®] -7 VC707	Set jumper J49 so that it connects pins 5 and 6. This setting selects 8-lane PCIe (<i>not</i> the default board setting).	http://www.xilinx.com/products/boards-and-kits/ek-v7-vc707-g.html

- 4 Install the FPGA development board in a PCIe slot inside the host computer.

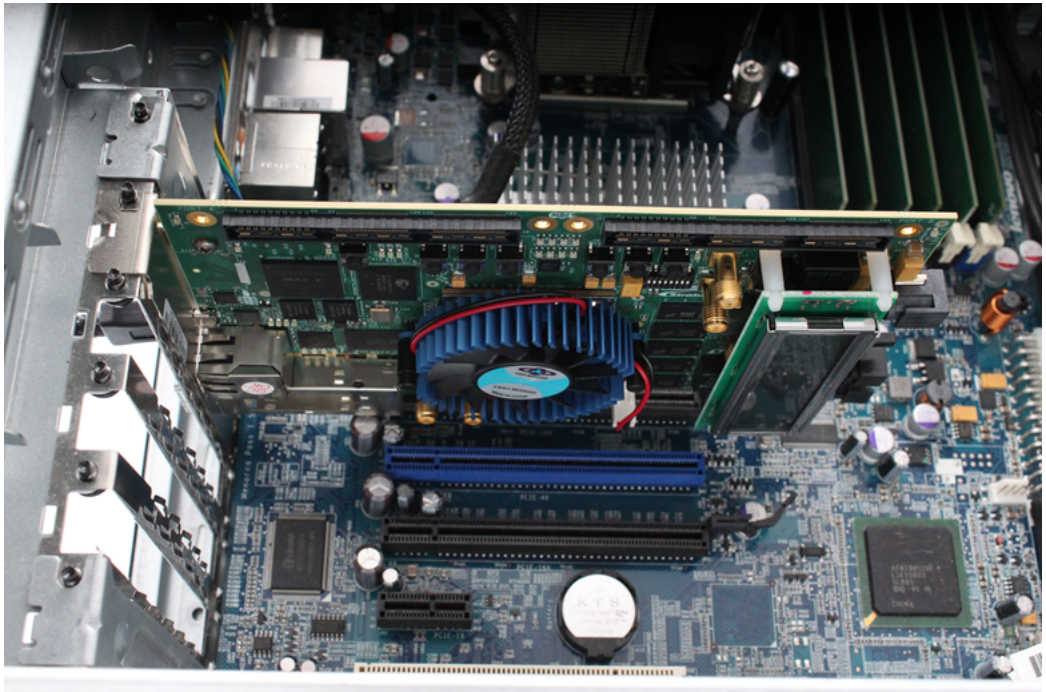

Stratix V Board Installed

This installation also applies to all supported Altera VC boards.

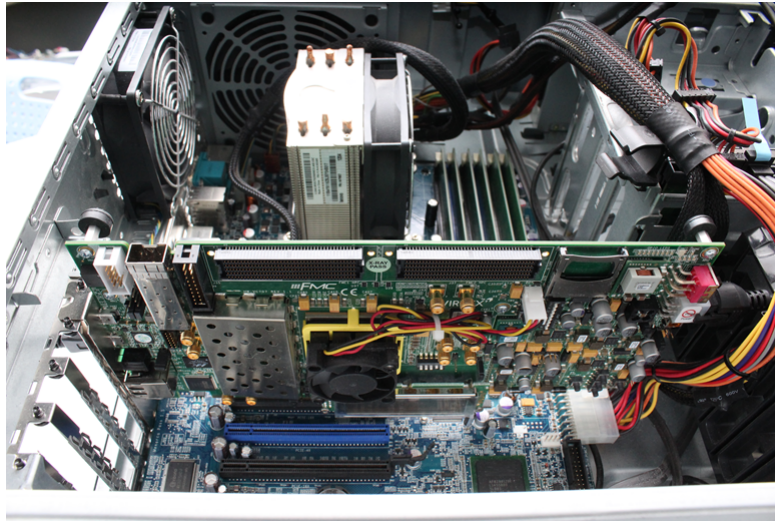

VC707 Board Installed

Note power cable on right. This installation also applies to all supported Xilinx boards.

- 5** For Xilinx boards, plug the external power supply into the wall outlet. Then plug the power supply adapter cable into the FPGA development board.
- Altera boards do not use an external power supply.
- 6** Connect the JTAG cable to the FPGA development board and the computer. When you use PCIe for FIL simulation, the JTAG cable is still required to program the FPGA.



- 7 Turn on the power switch on the FPGA board.
- 8 Start up the host computer.

Configure Network Card on Host

If you have already configured the network card, you can skip this step.

Specify the NIC on the host computer that you want to use with the development board and FIL. If you have only one NIC, you must disconnect from the Internet while using the NIC for FIL. In this case, consider using a USB 3.0 Gigabit Ethernet adapter dongle. If you add a NIC or a USB 3.0 Gigabit Ethernet adapter dongle during this setup step, click **Refresh** to see the new hardware in the list.

Leave the IP address for the NIC as the default, or specify the IP address in dotted quad format, for example, 192.168.0.1.

PCIe Driver Installation

If you have already installed the PCIe drivers, you can skip this step.

Install the PCIe drivers before you use FIL with a PCIe connection. This step performs the driver installation for you. The process can take 10 or more minutes to install, and might require system administrator privileges.

You can let the target updater install the drivers now, or you can choose to have the target updater install them for you later by re-running `targetupdater`.

Verify Setup

You can verify the hardware setup for Ethernet and JTAG connections. This step runs an FPGA-in-the-loop test, which generates an FPGA programming file for your board. You can also specify that this step include the FPGA board in the test, which means the step actually performs a FIL cosimulation with your board.

- 1 Make sure that you have installed the appropriate vendor tool and that the tool is on the MATLAB path. See “Set Up FPGA Design Software Tools” on page 10-7.
- 2 Select **Run FPGA-in-the-Loop test**. If you want to include the FPGA board in the test, select **Include FPGA board in the test**.
- 3 Click **Run Selected Tests**.

You can rerun the tests as many times as you like. When the tests have been completed to your satisfaction, you can continue with the target updater.

Open the Example

When the target updater completes your hardware setup, you can either exit the installer or open the Verify HDL Implementation of PID Controller Using FPGA-in-the-Loop example to get started.

More About

- “FPGA-in-the-Loop Simulation” on page 9-2

Manual Hardware Setup

FIL supports Ethernet, JTAG, and PCI Express connections. Some FPGA boards support multiple connection methods, and some boards support only one method. Choose setup instructions based on the connection method you plan to use for FIL simulation.

When possible, use the guided setup by running the target updater in MATLAB:

```
targetupdater
```

For more about the guided setup, see “Guided Hardware Setup” on page 10-8.

Step 1. Set Up FPGA Development Board

JTAG or Ethernet Connection

- 1 Make sure that the board power switch is OFF during these setup steps.
- 2 Make sure that all jumpers on the FPGA development board are in the factory default position.
- 3 Connect the AC power cord to the power plug.
- 4 Plug the power supply adapter cable into the FPGA development board.
- 5 Connect the JTAG cable to the FPGA development board and the computer. When you use Ethernet for FIL simulation, the JTAG cable is still required to program the FPGA.
- 6 If you plan to use an Ethernet connection for FIL simulation, connect the crossover Ethernet cable between the FPGA development board and the Ethernet adapter on your computer.
- 7 Turn on the power switch on the FPGA board.

PCI Express Connection

- 1 Turn off the host computer.
- 2 Make sure that the board power switch is OFF during these setup steps.
- 3 Select the maximum number of PCIe lanes supported by the board. Refer to the user manual for the board for details.

Supported Board	PCIe Setup	Documentation
DSP Development Kit, Stratix V Edition	Set the three switches (PCIE_PRSNT2nx1, x4,	https://www.altera.com/products/boards_and_kits/

Supported Board	PCIe Setup	Documentation
	x8) in dip switch SW6 to ON. This setting selects 8-lane PCIe (default board setting).	dev-kits/altera/kit-stratix-v-dsp.html
Cyclone V GT FPGA Development Kit	Set the two switches(PCIe_x1, x4) in dip switch SW3 to ON. This setting selects 4-lane PCIe (default board setting).	https://www.altera.com/products/boards_and_kits/dev-kits/altera/kit-cyclone-v-gt.html
Kintex-7 KC705	Set jumper J32 so that it connects pins 5 and 6. This setting selects 8-lane PCIe (default board setting).	http://www.xilinx.com/products/boards-and-kits/ek-k7-kc705-g.html
Virtex-7 VC707	Set jumper J49 so that it connects pins 5 and 6. This setting selects 8-lane PCIe (<i>not</i> the default board setting).	http://www.xilinx.com/products/boards-and-kits/ek-v7-vc707-g.html

- 4 Install the FPGA development board in a PCIe slot inside host computer.
- 5 For Xilinx boards, plug the external power supply into the wall outlet. Then plug the power supply adapter cable into the FPGA development board.

Altera boards do not use an external power supply.

- 6 Connect the JTAG cable to the FPGA development board and the computer. When you use PCIe for FIL simulation, the JTAG cable is still required to program the FPGA.
- 7 Turn on the power switch on the FPGA board.
- 8 Start up the host computer.

Step 2. Set Up Board Connection

HDL Verifier assumes that there is only one download cable connected to the host computer, and that the FPGA programming software can automatically detect this connection. If not, use FPGA programming software to program your FPGA with the correct options.

- “JTAG Connection” on page 10-17
- “Ethernet Connection” on page 10-17
- “PCI Express Connection” on page 10-21

JTAG Connection

Altera

- 1 Install USB Blaster I or II cable driver.
- 2 When using Linux operating systems: The Quartus II library must be present in `LD_LIBRARY_PATH` *before* you start MATLAB. Prepend the Linux distribution library path before the Quartus II library on `LD_LIBRARY_PATH`. For example, `/lib/x86_64-linux-gnu:$QUARTUS_LATEST/./linux64`.

Xilinx

- 1 For Linux operating systems: Install Digilent® Adept2.

Ethernet Connection

Follow these instructions to set up a Gigabit Ethernet network adapter on your computer for FIL simulation.

Windows 7 Setup

- 1 Open the Control Panel and type "view network connections" in the search bar. Select **View network connections** in the search results.
- 2 Right-click the connection icon to your FPGA development board, and select Properties from the pop-up menu.

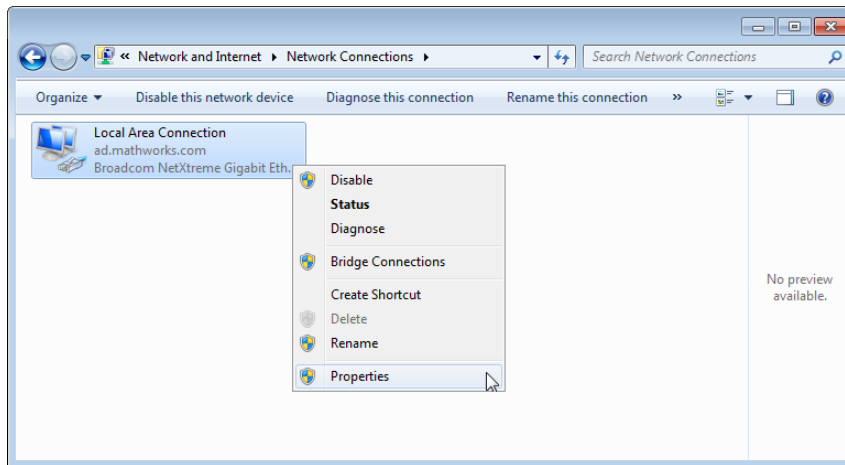

- 3 Under **This connection** uses the following items, select **Internet Protocol Version 4 (TCP/IPv4)**, and click **Properties**.

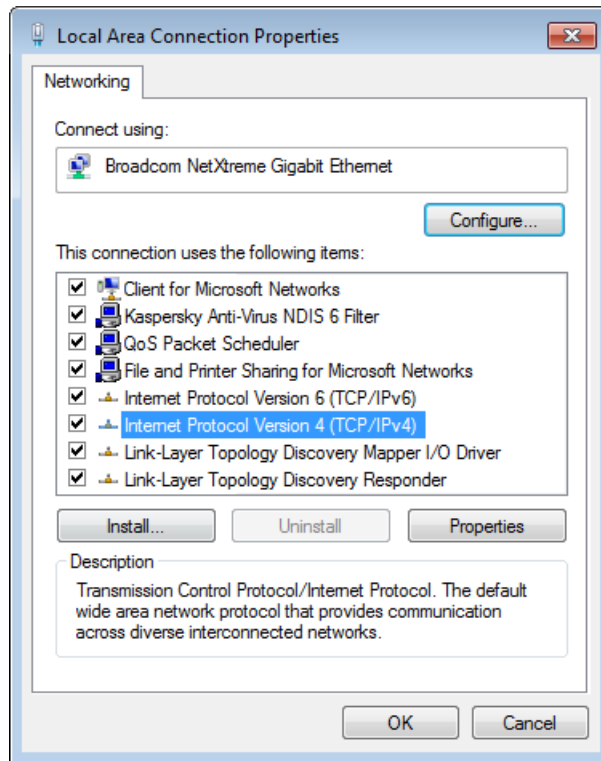

- 4 Select **Use the following IP address** and set **IP address** to 192.168.0.1. If this address is in use by another computer on your network, change it to any available IP address on this subnet, such as 192.168.0.100. This value indicates your host computer address. Set the **Subnet mask** to 255.255.255.0.

The figure shows an example TCP/IP configuration.

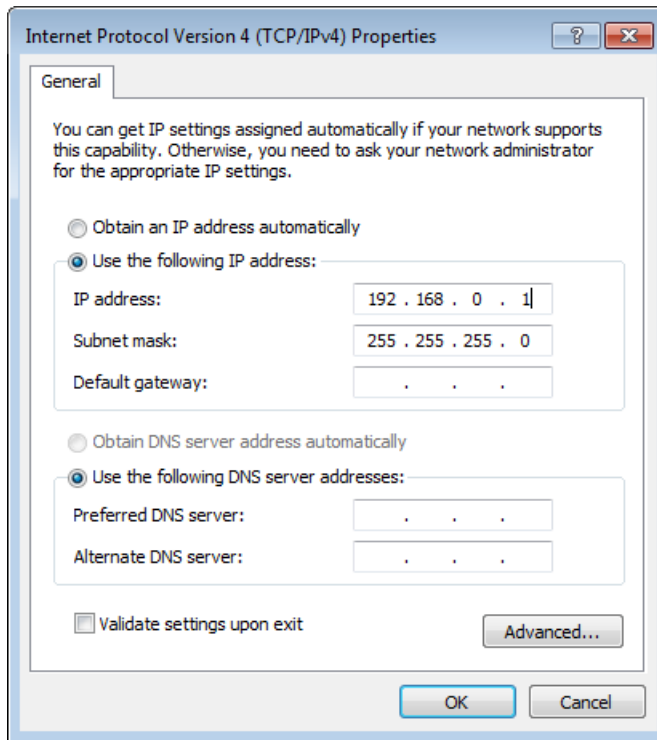

- 5 Click **OK** to exit TCP/IP Properties.
- 6 Click **Close** to exit Local Area Connection Properties.

Windows Vista Setup

- 1 Open the Control Panel.
- 2 Click Network and Sharing Center, and then click Manage network connections.
- 3 Right-click the connection icon to your FPGA development board, and select Properties from the pop-up menu.
- 4 Under **This connection uses the following items**, select **Internet Protocol Version 4 (TCP/IPv4)**, and click **Properties**.
- 5 Select **Use the following IP address** and set **IP address** to 192.168.0.1. If this address is in use by another computer on your network, change it to any available IP address on this subnet, such as 192.168.0.100. This value indicates your host computer address. Set the **Subnet mask** to 255.255.255.0.

- 6 Click **OK** to exit TCP/IP Properties.
- 7 Click **Close** to exit Local Area Connection Properties.

Windows XP Setup

- 1 Open the Control Panel.
- 2 Open Network connections.
- 3 Right-click the connection icon to your FPGA development board, and select Properties from the pop-up menu.
- 4 Under **This connection uses the following items**, select **Internet Protocol (TCP/IP)**, and click **Properties**.
- 5 Select **Use the following IP address** and set **IP address** to 192.168.0.1. If this address is in use by another computer on your network, change it to any available IP address on this subnet, such as 192.168.0.100. This value indicates your host computer address. Set the **Subnet mask** to 255.255.255.0.
- 6 Click **OK** to exit TCP/IP Properties.
- 7 Click **Close** to exit Local Area Connection Properties.

Linux Setup

Use the `ifconfig` command to set up your local address. For example:

```
% ifconfig eth1 192.168.0.1
```

In this example, `eth1` is the second Ethernet adapter on the Linux computer. Check your system to determine which Ethernet adapter is connected to the FPGA development board. This command sets the local IP address to 192.168.0.1. If this address is in use by another computer on your network, change it to any available IP address on this subnet, such as 192.168.0.100.

PCI Express Connection

FIL over PCI Express connection is supported only for 64-bit Windows operating systems.

- 1 Install the PCI Express drivers for your board using the FPGA board support package installer.
- 2 After you program your FPGA development board, restart your computer. The operating system automatically detects the new PCIe connection. See “Load

Programming File onto FPGA” > “PCI Express Connection” under “Perform FPGA-in-the-Loop Simulation” on page 11-25.

Prepare DUT For FIL Interface Generation

In this section...

“Files and Information Required for FIL Generation” on page 10-23

“Apply FIL System Object Requirements” on page 10-24

“Apply FIL Block Requirements” on page 10-27

Files and Information Required for FIL Generation

- “For FIL Wizard” on page 10-23
- “For HDL Workflow Advisor” on page 10-23

For FIL Wizard

Have the following items or information ready:

- Provide HDL code (either manually written or software generated) for the design you intend to test.
- Select HDL files and specify the top-level module name.
- Review port settings and make sure the FIL wizard identified input and output signals and signal sizes as expected.
- If you are using Simulink, provide a Simulink model ready to receive the generated FIL block.

Next Steps

- If you are creating a FIL System object, next go to “Apply FIL System Object Requirements” on page 10-24.
- If you are creating a FIL block, next go to “Apply FIL Block Requirements” on page 10-27.

For HDL Workflow Advisor

You can generate code and run FIL from any suitable Simulink model.

Next Steps

- If you are creating a FIL System object, next go to “Apply FIL System Object Requirements” on page 10-24.

- If you are creating a FIL block, next go to “Apply FIL Block Requirements” on page 10-27.

Apply FIL System Object Requirements

- “The FIL Process for System Objects” on page 10-24
- “HDL Code Considerations for FIL System Objects” on page 10-25
- “FIL-Specific Rules for System Objects” on page 10-27
- “MATLAB Code Considerations for FIL System Objects” on page 10-27

The FIL Process for System Objects

The FIL wizard and HDL Coder HDL Workflow Advisor each perform the following actions:

- Convert HDL code into System object inputs and outputs.
- Walk you through identifying: FPGA device, source files, I/O ports, and port info.
- Add logic to the device under test (DUT) to communicate with MATLAB.

Generally, this logic is small and has minimal impact on the fit of your design onto the FPGA.

- Create the programming file and a FIL System object.

Note: If a design does not fit in the device or does not meet timing goals, the software may not create a programming file. In this situation, you may see a warning that the design does not meet the timing goals, but it still generates a programming file, or you may get an error and no programming file. Either change your design, or use a different development board.

When FIL interface generation is complete, you can use the method `programFPGA` to load the programming file to the FPGA board. You can also use this method to adjust runtime options and signal attributes.

When you are ready to begin, read through the following topics and make sure that your DUT adheres to the rules and guidelines described in each section:

- “HDL Code Considerations for FIL System Objects” on page 10-25

- “FIL-Specific Rules for System Objects” on page 10-27
- “MATLAB Code Considerations for FIL System Objects” on page 10-27

When you are finished with these sections, next go to either “System Object Generation with the FIL Wizard” on page 11-12 or “FIL Simulation with HDL Workflow Advisor for MATLAB” on page 12-10.

HDL Code Considerations for FIL System Objects

Follow these rules when using legacy or auto-generated HDL code for generating a FIL System object.

Category	Considerations
HDL files	All HDL names must be legal as defined in the VHDL 1993 standard.
Top-level design	<ul style="list-style-type: none"> • The top-level design must be VHDL or Verilog. • The top-level HDL file must contain an entity/module with the same name as the file name. • FIL block generation supports both combinatorial and sequential logic. For combinatorial logic, CLK, CLK_ENABLE, and RESET are not required.
Inputs and outputs	<ul style="list-style-type: none"> • Input and output ports must be of the following types: <ul style="list-style-type: none"> • std_logic (VHDL) • std_logic_vector (VHDL) • Reg, wire (Verilog) • Vector ports range must be: <ul style="list-style-type: none"> • Descending (e.g. 9 DOWNTO 0, 9:0) • Literal. Use of generics (VHDL) or parameters (Verilog) is not supported. (e.g. a DOWNTO b or a:b is not supported) <p style="margin-left: 40px;">Descending TO syntax is not supported</p> • For Verilog, ports names must be lowercase. Module name must be lowercase, also. • All input and output ports must be included. • There must be at least one output port.

Category	Considerations
Clock	<ul style="list-style-type: none"> • Sequential HDL design must have only one clock at the top entity. Clock and reset are required. For combinatorial HDL design, the clock bundle is not required. • Name your clock signal <code>clock</code> or <code>clk</code>. If the clock is not named <code>clock</code> or <code>clk</code>, designate which signal is the clock signal in the FIL wizard. • Clock port must be 1-bit. For VHDL, it must be of type <code>std_logic</code>.
Reset	<ul style="list-style-type: none"> • The HDL design must have a reset to be able to reset the FPGA before simulation. • For sequential design, there must be only one reset. Clock and reset are required. For combinatorial HDL design, the clock bundle is not required. • Name your reset signal <code>reset</code> or <code>rst</code>. If the reset is not named <code>reset</code> or <code>rst</code>, designate which signal is the reset signal in the FIL wizard. • Reset port must be 1-bit. For VHDL, these ports must be of type <code>std_logic</code>.
Clock enable	<ul style="list-style-type: none"> • For sequential design, if you choose a clock enable, there must be only one. • Clock enable port must be 1-bit. For VHDL, these ports must be of type <code>std_logic</code>. • If you have a clock enable, name it one of the following: <code>clock_enable</code>, <code>clock_enb</code>, <code>clock_en</code>, <code>clk_enable</code>, <code>clk_enb</code>, <code>clk_en</code>, <code>ce</code>. If the clock enable is not named one of these names, designate which signal is the clock enable signal in the FIL wizard.
DUT entity	All the ports at DUT level must specify a bit width. Using a variable as the bit width is not allowed.
Clock edge	Clock the DUT input and output ports by positive edge. Negative edge is not allowed.
Non-supported data types	<ul style="list-style-type: none"> • Bidirectional ports • Arrays, record types

Category	Considerations
Non-supported constructs	<ul style="list-style-type: none"> • VHDL configuration statement • Verilog include files • Macros • Escaped names • Duplicated port names (Verilog)

FIL-Specific Rules for System Objects

FIL input and output data set limits	<ul style="list-style-type: none"> • Total input data size must be less than 1467 bytes The input data size is the sum of the input bits rounded up to the nearest byte • Output data size must also be less than 1467 bytes The output data size is the sum of the output bits rounded up to the nearest byte, times the overclocking factor
Output frame size	output frame size = input frame size * overclocking / downsample

MATLAB Code Considerations for FIL System Objects

MATLAB compatibilities	<p>HDL Verifier FIL simulation supports only the following data types:</p> <ul style="list-style-type: none"> • Integer • Logical • Fixed point
------------------------	--

Apply FIL Block Requirements

- “The FIL Process for Blocks” on page 10-28
- “HDL Code Considerations for FIL Blocks” on page 10-28
- “Simulink Model Considerations for FIL Blocks” on page 10-31
- “FIL-Specific Rules for Blocks” on page 10-31

The FIL Process for Blocks

The FIL wizard and HDL Coder HDL Workflow Advisor each perform the following actions:

- Convert HDL code into block signals with timing applied.
- Walk you through identifying: FPGA device, source files, I/O ports, and port info.
- Add logic to the device under test (DUT) to communicate with Simulink.

Generally, this logic is small and has minimal impact on the fit of your design onto the FPGA.

- Create the programming file and a FIL simulation block.

Note: If a design does not fit in the device or does not meet timing goals, the software may not create a programming file. In this situation, you may see a warning that the design does not meet the timing goals, but it still generates a programming file, or you may get an error and no programming file. Either change your design, or use a different development board.

After FIL interface generation is complete, use the FIL block mask to load the programming file to the FPGA board. You can also adjust runtime options and signal attributes.

When you are ready to begin, read through the following topics and make sure that your DUT adheres to the rules and guidelines described in each section:

- “HDL Code Considerations for FIL Blocks” on page 10-28
- “Simulink Model Considerations for FIL Blocks” on page 10-31
- “FIL-Specific Rules for Blocks” on page 10-31

When you are finished with these sections, next go to “Block Generation with the FIL Wizard” on page 11-2 or “FIL Simulation with HDL Workflow Advisor for Simulink” on page 12-2.

HDL Code Considerations for FIL Blocks

Follow these rules when using legacy or auto-generated HDL code for generating a FIL block.

Category	Considerations
HDL files	All HDL names must be legal as defined in the VHDL 1993 standard.
Top-level design	<ul style="list-style-type: none"> • The top-level design must be VHDL or Verilog. • The top-level HDL file must contain an entity/module with the same name as the file name. • FIL block generation supports both combinatorial and sequential logic. For combinatorial logic, CLK, CLK_ENABLE, and RESET are not required.
Inputs and outputs	<ul style="list-style-type: none"> • Input and output ports must be of the following types: <ul style="list-style-type: none"> • std_logic (VHDL) • std_logic_vector (VHDL) • Reg, wire (Verilog) • Vector ports range must be: <ul style="list-style-type: none"> • Descending (e.g. 9 DOWNTO 0, 9:0) • Literal. Use of generics (VHDL) or parameters (Verilog) is not supported. (e.g. a DOWNTO b or a:b is not supported) <p style="margin-left: 40px;">Descending TO syntax is not supported</p> • For Verilog, ports names must be lowercase. Module name must be lowercase, also. • All input and output ports must be included. • There must be at least one output port.
Clock	<ul style="list-style-type: none"> • Sequential HDL design must have only one clock at the top entity. Clock and reset are required. For combinatorial HDL design, the clock bundle is not required. • Name your clock signal <code>clock</code> or <code>clk</code>. If the clock is not named <code>clock</code> or <code>clk</code>, designate which signal is the clock signal in the FIL wizard. • Clock port must be 1-bit. For VHDL, it must be of type <code>std_logic</code>.

Category	Considerations
Reset	<ul style="list-style-type: none"> • The HDL design must have a reset to be able to reset the FPGA before simulation. • For sequential design, there must be only one reset. Clock and reset are required. For combinatorial HDL design, the clock bundle is not required. • Name your reset signal <code>reset</code> or <code>rst</code>. If the reset is not named <code>reset</code> or <code>rst</code>, designate which signal is the reset signal in the FIL wizard. • Reset port must be 1-bit. For VHDL, these ports must be of type <code>std_logic</code>.
Clock enable	<ul style="list-style-type: none"> • For sequential design, if you choose a clock enable, there must be only one. • Clock enable port must be 1-bit. For VHDL, these ports must be of type <code>std_logic</code>. • If you have a clock enable, name it one of the following: <code>clock_enable</code>, <code>clock_enb</code>, <code>clock_en</code>, <code>clk_enable</code>, <code>clk_enb</code>, <code>clk_en</code>, <code>ce</code>. If the clock enable is not named one of these names, designate which signal is the clock enable signal in the FIL wizard.
DUT entity	All the ports at DUT level must specify a bit width. Using a variable as the bit width is not allowed.
Clock edge	Clock the DUT input and output ports by positive edge. Negative edge is not allowed.
Non-supported data types	<ul style="list-style-type: none"> • Bidirectional ports • Arrays, record types
Non-supported constructs	<ul style="list-style-type: none"> • VHDL configuration statement • Verilog include files • Macros • Escaped names • Duplicated port names (Verilog)

Simulink Model Considerations for FIL Blocks

Follow these rules for integrating the FIL block into your Simulink model.

Category	Considerations
General model rules	<ul style="list-style-type: none"> • Use Single tasking solver mode (set with Configuration Parameters). HDL Verifier FIL does not support multitasking solver mode. • Choose discrete, fixed-step solvers or variable-step solvers. HDL Verifier FIL supports both types of solvers.
Incompatibilities with Simulink	<p>HDL Verifier FIL simulation currently does not support the following:</p> <ul style="list-style-type: none"> • Instantiation of the FIL block in a triggered subsystem • Instantiation of the FIL block in an asynchronous function-call subsystem • A continuous sample time • A nonzero sample time offset
Initialization	<p>RAM Initialization: Simulink starts from time 0 every time, which means the RAM in a Simulink model is initialized to zero for each run. However, this assumption is not true in hardware. RAM in the FPGA holds its value from the end of one simulation to the start of the next. If you have RAM in your design, the first simulation matches Simulink, but subsequent runs may not match. The workaround is to reload the FPGA bitstream before rerunning the simulation. To reload the bitstream, click the Load on the FIL block mask.</p>

FIL-Specific Rules for Blocks

FIL block settings rules	<ul style="list-style-type: none"> • The input frame size must be an integer multiple of the output frame size. • All signals must be of the same bit-width as their corresponding port in the hardware. • In frame mode, all inputs must have the same frame size and all outputs must have the same frame size (but possibly different from the inputs).
--------------------------	---

- When processing as frames, all input signals must have the same sample times and all output signals must have the same sample times. The output sample time can be different from the input sample time.
- When processing as samples, only scalars are supported. When processing as frames, only column vectors (N-by-1) are supported.
- Supported data types are built-in data types and fixed-point data types.
- Split complex signals into real and imaginary signals. FIL simulation does not support complex signals.
- The output frame size must be less than the input frame size. This requirement ensures that the output frame has enough data to drive a value at time 0. You can avoid this error by either decreasing the output frame size or sample time, or increasing the input frame size or sample time.

FIL byte size limit

- Total input data size must be less than 1467 bytes.

The input data size is the sum of the input bits rounded up to the nearest byte.

- Output data size must also be less than 1467 bytes.

The output data size is the sum of the output bits rounded up to the nearest byte, times the overclocking factor.

For example, a subsystem with one 9-bit input (2 bytes) and one 16-bit input (2 bytes) would have an input data set of 4 bytes.

The overclocking factor is calculated based on one of these equations:

- $$\text{OCF} = \frac{\text{fastest_dut_sample_rate}}{\text{fastest_input_sample_rate}}$$

Or

- $$\text{OCF} = \frac{\text{input_sample_time}}{\text{fastest_dut_sample_time}}$$

Where $\text{sample_time} = 1/\text{samplerate}$.

The overclocking factor is greater than 1 when there is upsampling in the DUT, which results in a smaller DUT sample time compared to the input.

Examine the following diagram:

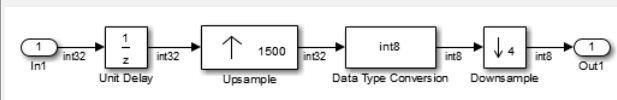

- The input data set is 4 bytes.
- The overclocking factor is 1500.

The input sample time equals the sample rate which in turn equals 1. The fastest sample time equals 1/1500

(the fastest sample rate is 1500). Therefore, the overclocking factor is 1500.

- The output data set is $1 * 1500 = 1500$ bytes, exceeding the data set limit.

FIL Interface Generation and Simulation

- “Block Generation with the FIL Wizard” on page 11-2
- “System Object Generation with the FIL Wizard” on page 11-12
- “Perform FPGA-in-the-Loop Simulation” on page 11-25

Block Generation with the FIL Wizard

In this section...

“Step 1: Set Up FPGA Design Software Tools” on page 11-2

“Step 2: Start FIL Wizard” on page 11-3

“Step 3: Set FIL Options for FIL Block” on page 11-4

“Step 4: Add HDL Source Files for FIL Block” on page 11-6

“Step 5: Verify DUT I/O Ports for FIL Block” on page 11-8

“Step 6: Specify Output Types for FIL Block” on page 11-9

“Step 7: Specify Build Options for FIL Block” on page 11-10

“Step 8: Initiate Build” on page 11-11

Step 1: Set Up FPGA Design Software Tools

Xilinx ISE

Set up your system environment for accessing Xilinx ISE from MATLAB with the function `hdlsetuptoolpath`. This function adds the required folders to the MATLAB search path using the Xilinx installation folder as its argument.

For example, with Xilinx ISE:

```
hdlsetuptoolpath('ToolName','Xilinx ISE','ToolPath','C:\Xilinx\14.2\ISE_DS\ISE\bin\nt64')
```

This example assumes that the Xilinx ISE design suite is installed at `C:\Xilinx\14.2\ISE_DS\ISE\bin\nt64`.

For Vivado:

```
hdlsetuptoolpath('ToolName','Xilinx Vivado','ToolPath','C:\apps\Vivado\2013.4-mw-0\Win
```

This example assumes that Xilinx Vivado is installed at `C:\apps\Vivado\2013.4-mw-0\Win\bin\vivado`.

Altera

Set up your system environment for accessing from MATLAB with the function `hdlsetuptoolpath`. For example:

```
hdlsetuptoolpath('ToolName','Altera Quartus II','ToolPath','C:\Altera\12.0\quartus\bin64')
```

This example assumes that the Altera FPGA design software is installed at C:\Altera\12.0\quartus\bin64.

Step 2: Start FIL Wizard

Open the FPGA-in-the-loop wizard by selecting one of the following invocation methods:

- In the MATLAB command window, type the following:

```
>> filWizard
```

- In the Simulink model window, select **Code > Verification Wizards > FPGA-in-the-Loop (FIL)**.

To restore a previous session, use this command:

```
filWizard('./Subsystem_fil/Subsystem_fil.mat')
```

Step 3: Set FIL Options for FIL Block

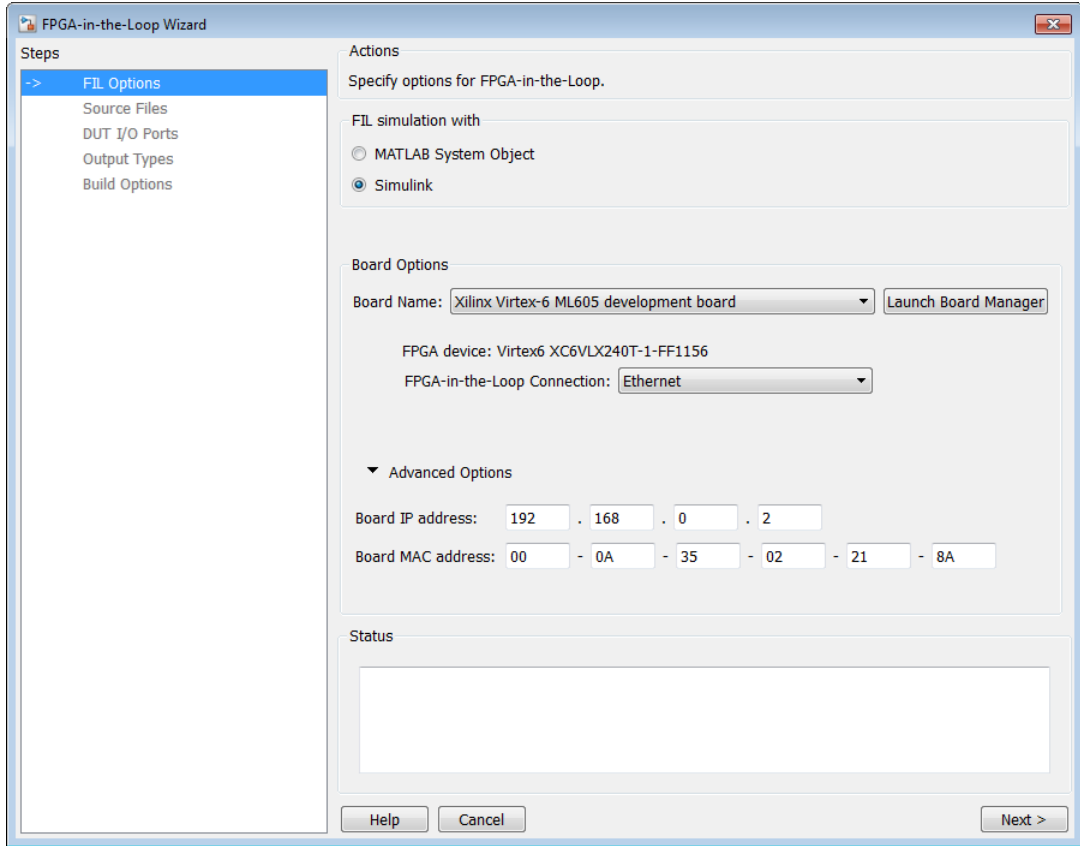

In the **FIL Options** page:

- 1 **FIL Simulation:** Select Simulink.
- 2 **Board Name:** Select an FPGA development board. If you have not yet downloaded an HDL Verifier FPGA board support package, see “Download FPGA Board Support Package” on page 10-3. (If you do not see any boards listed, then you have not yet downloaded a support package). If you plan to define a custom board yourself, see “FPGA Board Customization” on page 15-2.
- 3 **FPGA-in-the-Loop Connection:** FIL simulation connection method. The options in the drop-down menu update depending on the connection methods supported

for the target board you selected. If the target board and HDL Verifier support the connection, you can choose Ethernet, JTAG, or PCI Express.

4 Advanced Options:

When you select an Ethernet connection, you can adjust the board IP and MAC addresses, if necessary.

Option	Instructions
Board IP address	<p>Use this option for setting the IP address of the board if it is not the default IP address (192.168.0.2).</p> <p>If the default board IP address (192.168.0.2) is in use by another device, or you need a different subnet, change the Board IP address according to the following guidelines:</p> <ul style="list-style-type: none"> • The subnet address, typically the first three bytes of board IP address, must be the same as the subnet of the host IP address. • The last byte of the board IP address must be different from the last byte of the host IP address. • The board IP address must not conflict with the IP addresses of other computers. <p>For example, if the host IP address is 192.168.8.2, then you can use 192.168.8.3, if available.</p>
Board MAC address	<p>Under most circumstances, you do not need to change the board MAC address. If you connect more than one FPGA development board to a single host computer, change the board MAC address for any additional boards so that each address is unique. You must have a separate NIC for each board.</p> <p>To change the Board MAC address, click in the Board MAC address field. Specify an address that is different from that belonging to any other device attached to your computer. To obtain the Board MAC address for a specific FPGA development board, refer to the label affixed to the board or consult the product documentation.</p>

5 Click **Next**.

Step 4: Add HDL Source Files for FIL Block

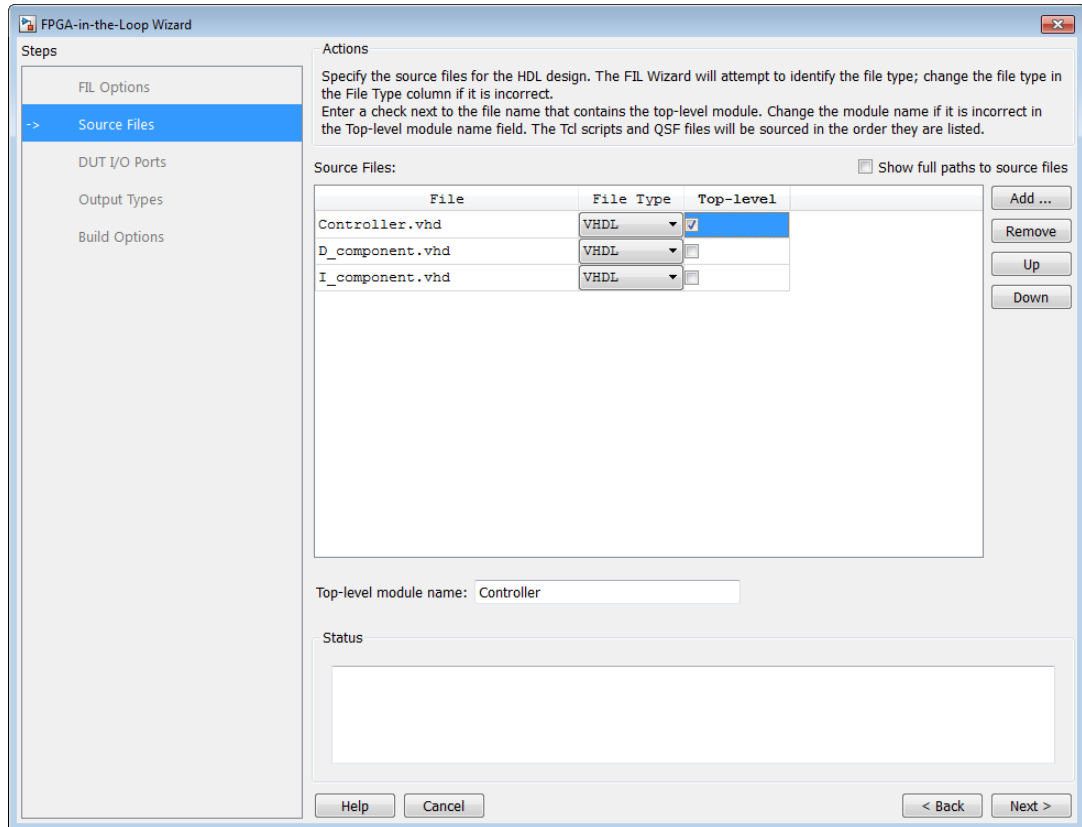

In the **Source Files** page:

- 1 Specify the HDL design to be cosimulated in the FPGA. These files are the HDL design files to be verified on the FPGA board.

Indicate source files by clicking **Add**. Select files using the file selection dialog box.

The FIL wizard attempts to identify the source file types. If any of the file types is not what you expect, you can change it by selecting from the **File Type** drop-down list. Acceptable file types are:

- VHDL
- Verilog
- Netlist
- Tcl script
- Constraints
- Others

"Others" refers to the following:

- For Altera, files specified as **Other** are added to the FPGA project, but they have no impact on the generated block. For example, you can put some comments in a “readme” file and include it in this file list.
- For Xilinx, files specified as **Other** can be any file accepted by Xilinx ISE. ISE looks at the file extension to determine how to use this file. For example, if you add foo.vhd to the list and specify it as **Other**, ISE treats the file as a VHDL file.

- 2 Specify which file contains the top-level HDL file.

Check the box on the row of the HDL file that contains the top-level HDL module in the column titled **Top-level**. The FIL wizard automatically fills the **Top-level module name** field with the name of the selected HDL file. If the top-level module name and file name do not match, you can manually change the top-level module name in this dialog box. Indicate the top-level module name before you continue.

- 3 (Optional) To display the full paths to the source files, check the box titled **Show full paths to source files**.
- 4 Click **Next**.

Step 5: Verify DUT I/O Ports for FIL Block

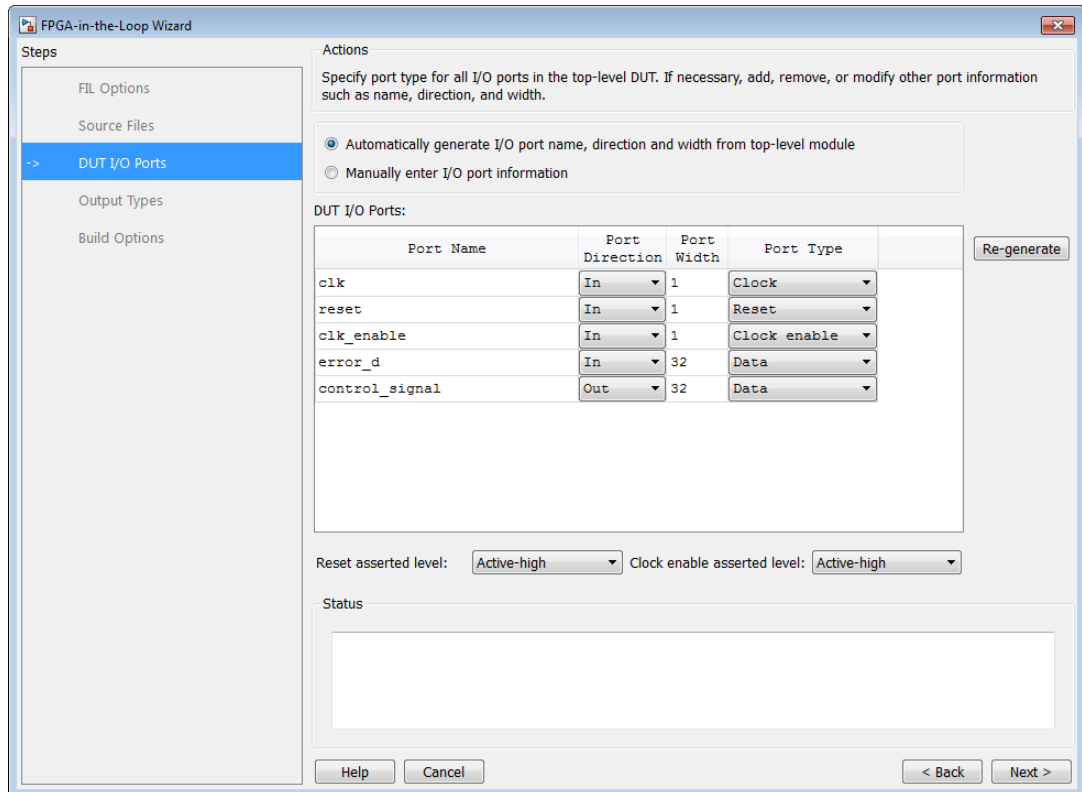

In the **DUT I/O Ports** page:

- 1 Review the port listing. The FIL wizard parses the top-level HDL module to obtain all the I/O ports and display them in the DUT I/O Ports table. The parser attempts to determine the port types from the port names. The wizard then displays these signals under Port Type.

Make sure all input/output/reset ports/clocks are mapped as you expect. If the parser assigned an incorrect port type for any port, you can manually change the signal. For synchronous design, specify a Clock, Reset, or, if desired, a Clock enable signal. The port types specified in this table must be the same as in the HDL code. There must be at least one output port.

Select **Manually enter port information** to add or remove signals.

Click **Regenerate** to reload the table with the original port definitions (from the HDL code).

- 2 Click **Next**.

Step 6: Specify Output Types for FIL Block

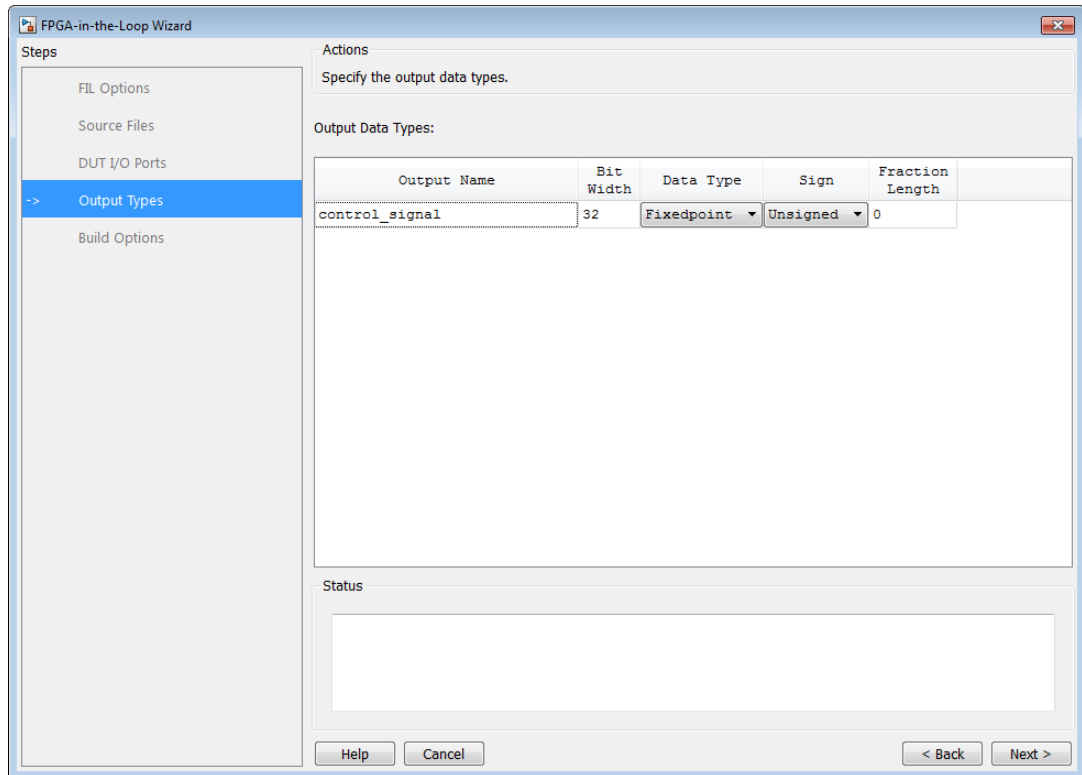

In the **Output Types** page:

- 1 Specify output data types. The wizard assigns data types. If any output data type is not what you expect, manually change the type.

Select from:

- Fixedpoint
- Integer
- Logical

The data type can depend on the specified bit width.

You can specify the output type to be Signed, Unsigned, or Fraction Length.

2 Click **Next**.

Step 7: Specify Build Options for FIL Block

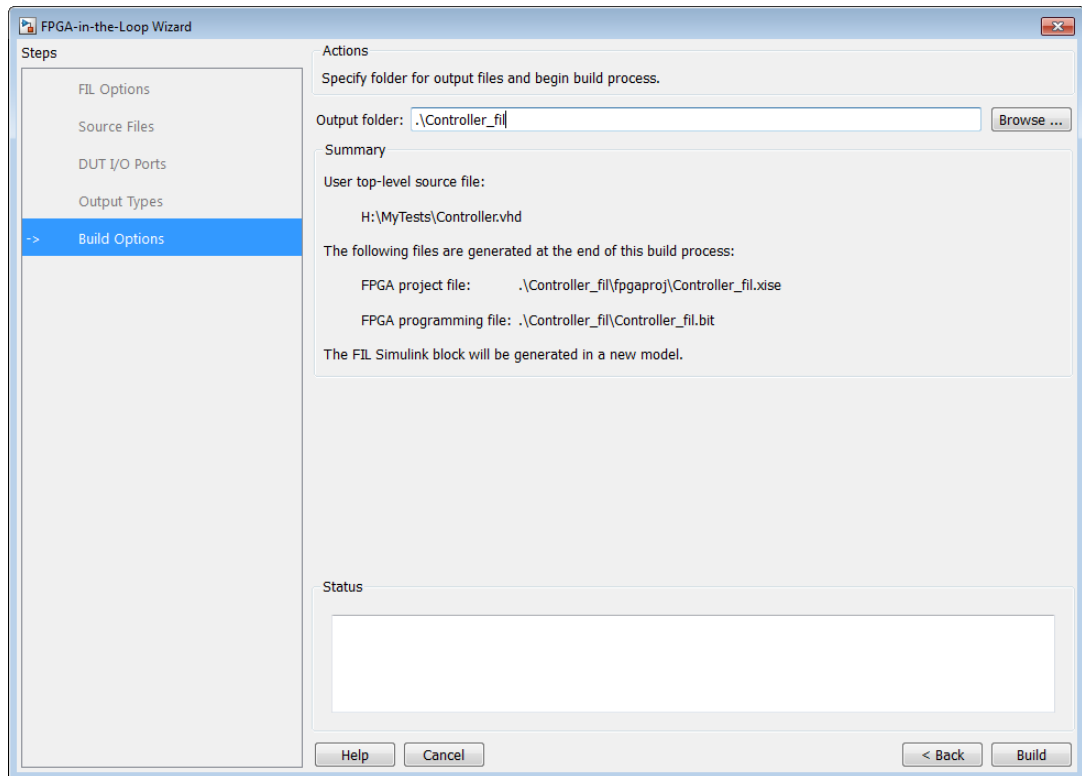

In the **Build Options** page:

- Specify the folder for the output files. You can use the default option. Usually the default is a subfolder named after the top-level module, located under the current folder.
- The **Summary** displays the locations of the ISE project file and the FPGA programming file. You may need those two files for advanced operations on the FIL block mask.

Step 8: Initiate Build

Click **Build** to initiate FIL block generation.

- 1 The FIL wizard generates a FIL block named after the top-level module and places it in a new model.
- 2 The FIL wizard opens a command window.
 - In this window, the FPGA design software performs synthesis, fit, PAR, and FPGA programming file generation.
 - When the process completes, a message in the command window prompts you to close the window.

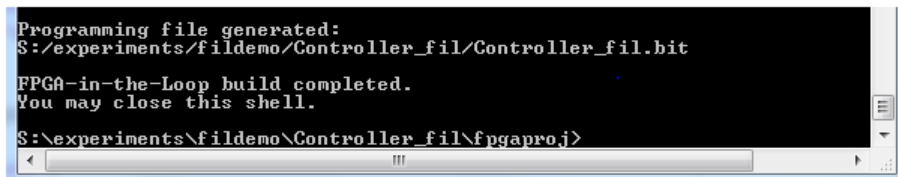

```
Programming file generated:  
S:/experiments/fildemo/Controller_fil/Controller_fil.bit  
FPGA-in-the-Loop build completed.  
You may close this shell.  
S:\experiments\fildemo\Controller_fil\fpgaproj>
```

When these steps are completed, see “Perform FPGA-in-the-Loop Simulation” on page 11-25.

System Object Generation with the FIL Wizard

In this section...

“Step 1: Set Up FPGA Design Software Tools” on page 11-2

“Step 2: Start FIL Wizard” on page 11-13

“Step 3: Set FIL Options for System Object” on page 11-13

“Step 4: Add HDL Source Files for System Object” on page 11-16

“Step 5: Verify DUT I/O Ports for System Object” on page 11-18

“Step 6: Specify Output Types for System Object” on page 11-19

“Step 7: Specify Build Options for System Object” on page 11-21

“Step 8: Initiate Build” on page 11-22

Step 1: Set Up FPGA Design Software Tools

Xilinx ISE

Set up your system environment for accessing Xilinx ISE from MATLAB with the function `hdlsetuptoolpath`. This function adds the required folders to the MATLAB search path using the Xilinx installation folder as its argument.

For example, with Xilinx ISE:

```
hdlsetuptoolpath('ToolName','Xilinx ISE','ToolPath','C:\Xilinx\14.2\ISE_DS\ISE\bin\nt64')
```

This example assumes that the Xilinx ISE design suite is installed at `C:\Xilinx\14.2\ISE_DS\ISE\bin\nt64`.

For Vivado:

```
hdlsetuptoolpath('ToolName','Xilinx Vivado','ToolPath','C:\apps\Vivado\2013.4-mw-0\Win
```

This example assumes that Xilinx Vivado is installed at `C:\apps\Vivado\2013.4-mw-0\Win\bin\vivado`.

Altera

Set up your system environment for accessing from MATLAB with the function `hdlsetuptoolpath`. For example:

```
hdlsetuptoolpath('ToolName','Altera Quartus II','ToolPath','C:\Altera\12.0\quartus\bin64')
```

This example assumes that the Altera FPGA design software is installed at `C:\Altera\12.0\quartus\bin64`.

Step 2: Start FIL Wizard

Launch the FPGA-in-the-loop wizard by invoking the `filWizard` function:

In the MATLAB command window, type the following:

```
>> filWizard
```

To restore a previous session, use this command:

```
filWizard('./Subsystem_fil/Subsystem_fil.mat')
```

Step 3: Set FIL Options for System Object

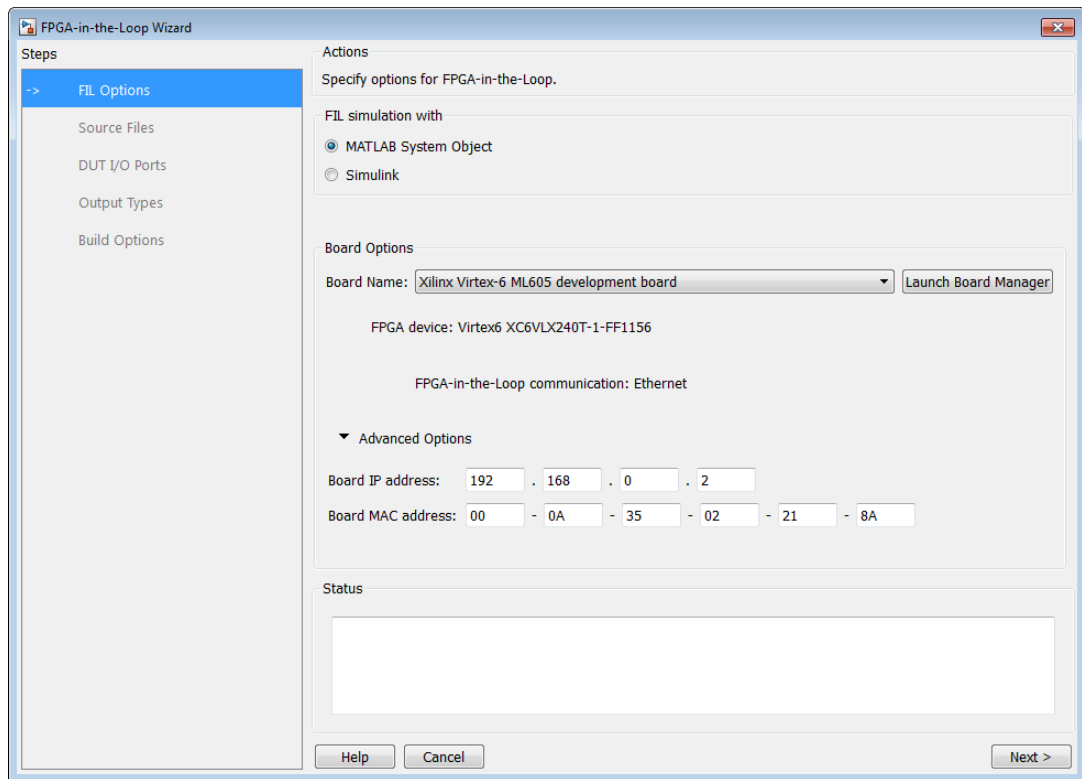

(This page is for FIL System object. For Simulink block FIL options, see “Step 3: Set FIL Options for FIL Block” on page 11-4.)

In the **FIL Options** page:

- 1 **FIL Simulation with:** Select **MATLAB System Object**.
- 2 **Board Name:** Select an FPGA development board. If you have not yet downloaded an HDL Verifier FPGA board support package, see “Download FPGA Board Support Package” on page 10-3. (If you do not see any boards listed, then you have not yet downloaded a support package). If you plan to define a custom board yourself, see “FPGA Board Customization” on page 15-2.
- 3 **FPGA-in-the-Loop Connection:** FIL simulation connection method. The options in the drop-down menu update depending on the connection methods supported for the target board you selected. If the target board and HDL Verifier support the connection, you can choose **Ethernet**, **JTAG**, or **PCI Express**.
- 4 **Advanced Options:**

When you select an Ethernet connection, you can adjust the board IP and MAC addresses, if necessary.

Option	Instructions
Board IP address	<p>Use this option for setting the IP address of the board if it is not the default IP address (192.168.0.2).</p> <p>If the default board IP address (192.168.0.2) is in use by another device, or you need a different subnet, change the Board IP address according to the following guidelines:</p> <ul style="list-style-type: none"> • The subnet address, typically the first three bytes of board IP address, must be the same as the subnet of the host IP address. • The last byte of the board IP address must be different from the last byte of the host IP address. • The board IP address must not conflict with the IP addresses of other computers. <p>For example, if the host IP address is 192.168.8.2, then you can use 192.168.8.3, if available.</p>

Option	Instructions
Board MAC address	<p>Under most circumstances, you do not need to change the board MAC address. If you connect more than one FPGA development board to a single host computer, change the board MAC address for any additional boards so that each address is unique. You must have a separate NIC for each board.</p> <p>To change the Board MAC address, click in the Board MAC address field. Specify an address that is different from that belonging to any other device attached to your computer. To obtain the Board MAC address for a specific FPGA development board, refer to the label affixed to the board or consult the product documentation.</p>

5 Click **Next**.

Step 4: Add HDL Source Files for System Object

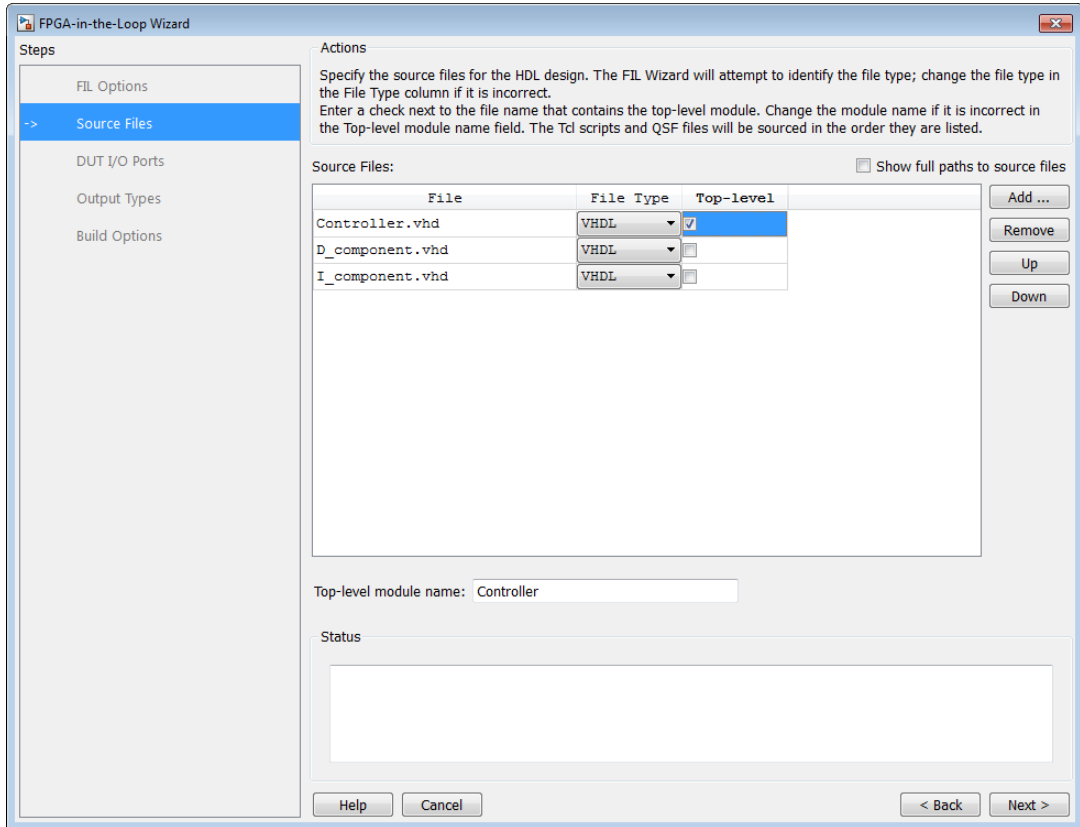

(This page is for FIL System object. For Simulink block HDL source files, see “Step 4: Add HDL Source Files for FIL Block” on page 11-6.)

In the **Source Files** page:

- 1 Specify the HDL design to be cosimulated in the FPGA. These files are the HDL design files to be verified on the FPGA board.

Indicate source files by clicking **Add**. Select files using the file selection dialog box.

The FIL wizard attempts to identify the source file types. If any of the file types is not what you expect, you can change it by selecting from the **File Type** drop-down list. Acceptable file types are:

- VHDL
- Verilog
- Netlist
- Tcl script
- Constraints
- Others

"Others" refers to the following:

- For Altera, files specified as **Other** are added to the FPGA project, but they have no impact on the generated block. For example, you can put some comments in a “readme” file and include it in this file list.
- For Xilinx, files specified as **Other** can be any file accepted by Xilinx ISE. ISE looks at the file extension to determine how to use this file. For example, if you add foo.vhd to the list and specify it as **Other**, ISE treats the file as a VHDL file.

2 Specify which file contains the top-level HDL file.

Check the box on the row of the HDL file that contains the top-level HDL module in the column titled **Top-level**. The FIL wizard automatically fills the **Top-level module name** field with the name of the selected HDL file. If the top-level module name and file name do not match, you can manually change the top-level module name in this dialog box. Indicate the top-level module name before you continue.

3 (Optional) To display the full paths to the source files, check the box titled **Show full paths to source files**.

4 Click **Next**.

Step 5: Verify DUT I/O Ports for System Object

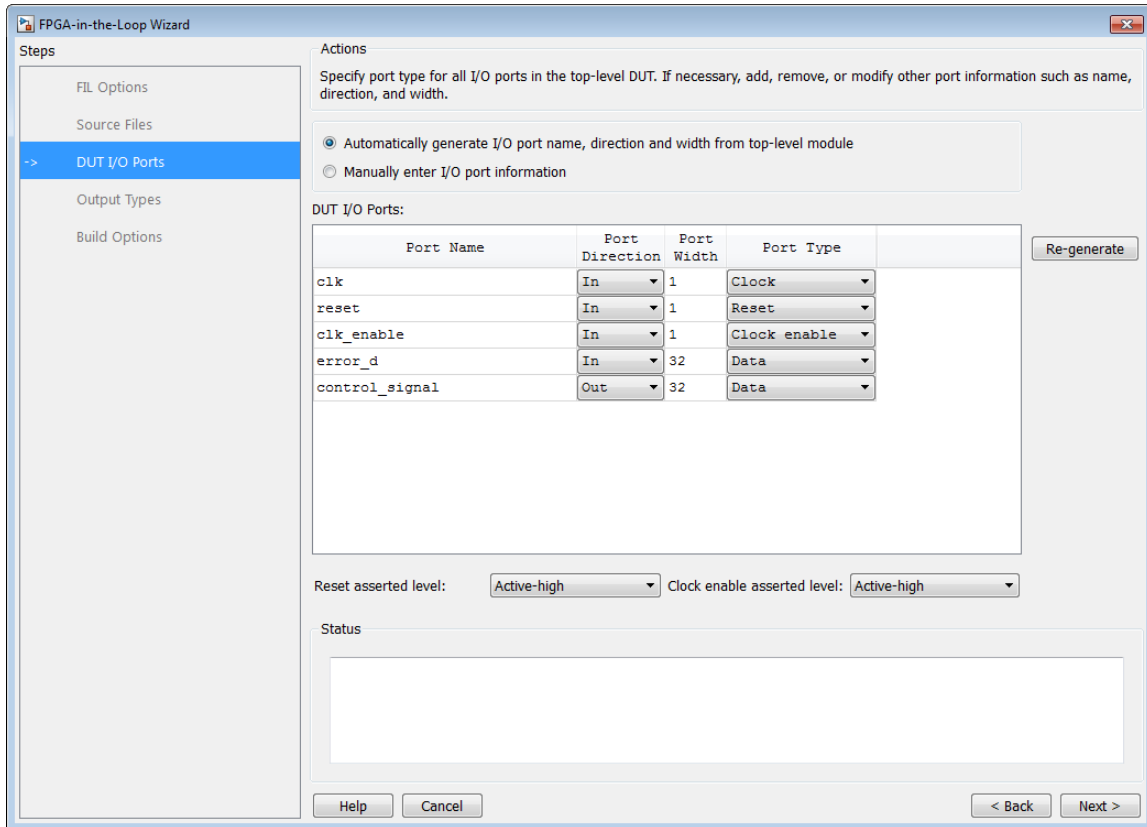

(This page is for FIL with a System object. For Simulink, see “Step 5: Verify DUT I/O Ports for FIL Block” on page 11-8.)

In the **DUT I/O Ports** page:

- 1 Review the port listing. The FIL wizard parses the top-level HDL module to obtain all the I/O ports and display them in the DUT I/O Ports table. The parser attempts to determine the port types from the port names. The wizard then displays these signals under Port Type.

Make sure all input/output/reset ports/clocks are mapped as you expect. If the parser assigned an incorrect port type for any port, you can manually change the signal. For

synchronous design, specify a Clock, Reset, or, if desired, a Clock enable signal. The port types specified in this table must be the same as in the HDL code. There must be at least one output port.

Select **Manually enter port information** to add or remove signals.

Click **Regenerate** to reload the table with the original port definitions (from the HDL code).

- 2 Click **Next**.

Step 6: Specify Output Types for System Object

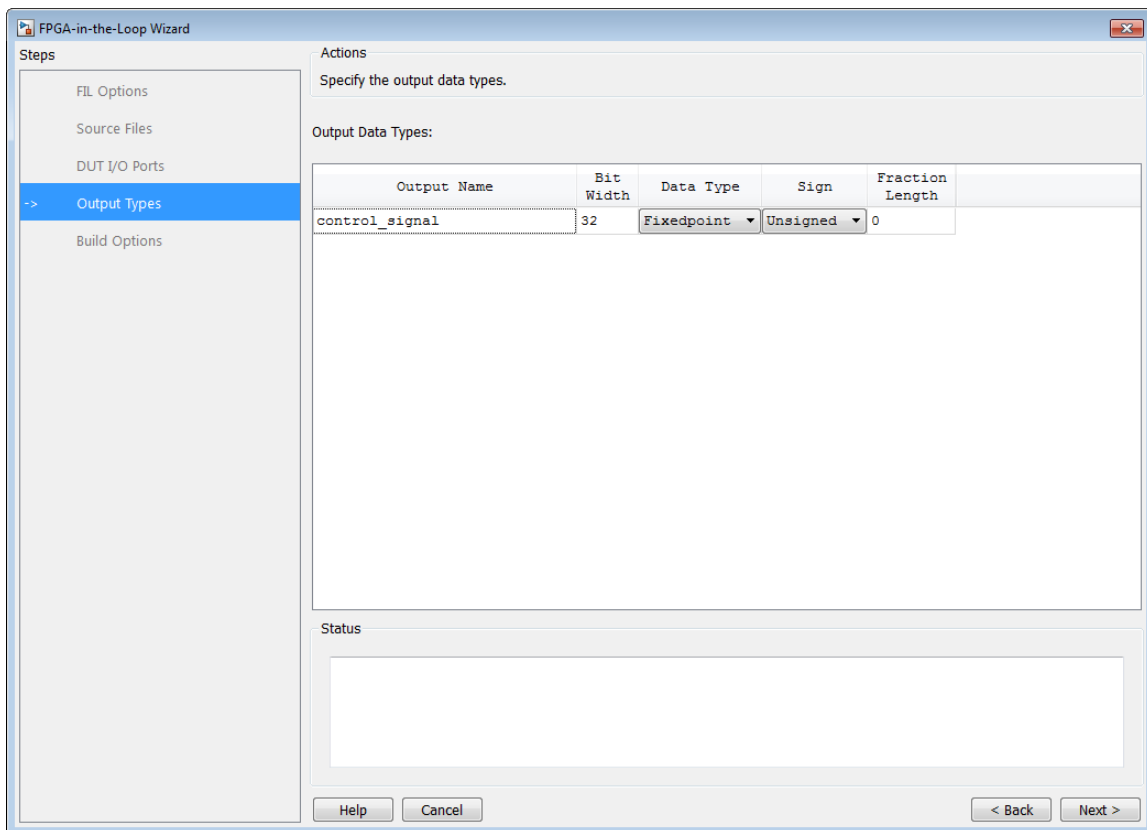

(This page is for FIL System object. For Simulink block output types, see “Step 6: Specify Output Types for FIL Block” on page 11-9.)

In the **Output Types** page:

- 1 Specify output data types. The wizard assigns data types. If any output data type is not what you expect, manually change the type.

Select from:

- Fixedpoint
- Integer
- Logical

The data type can depend on the specified bit width.

You can specify the output type to be **Signed**, **Unsigned**, or **Fraction Length**.

- 2 Click **Next**.

Step 7: Specify Build Options for System Object

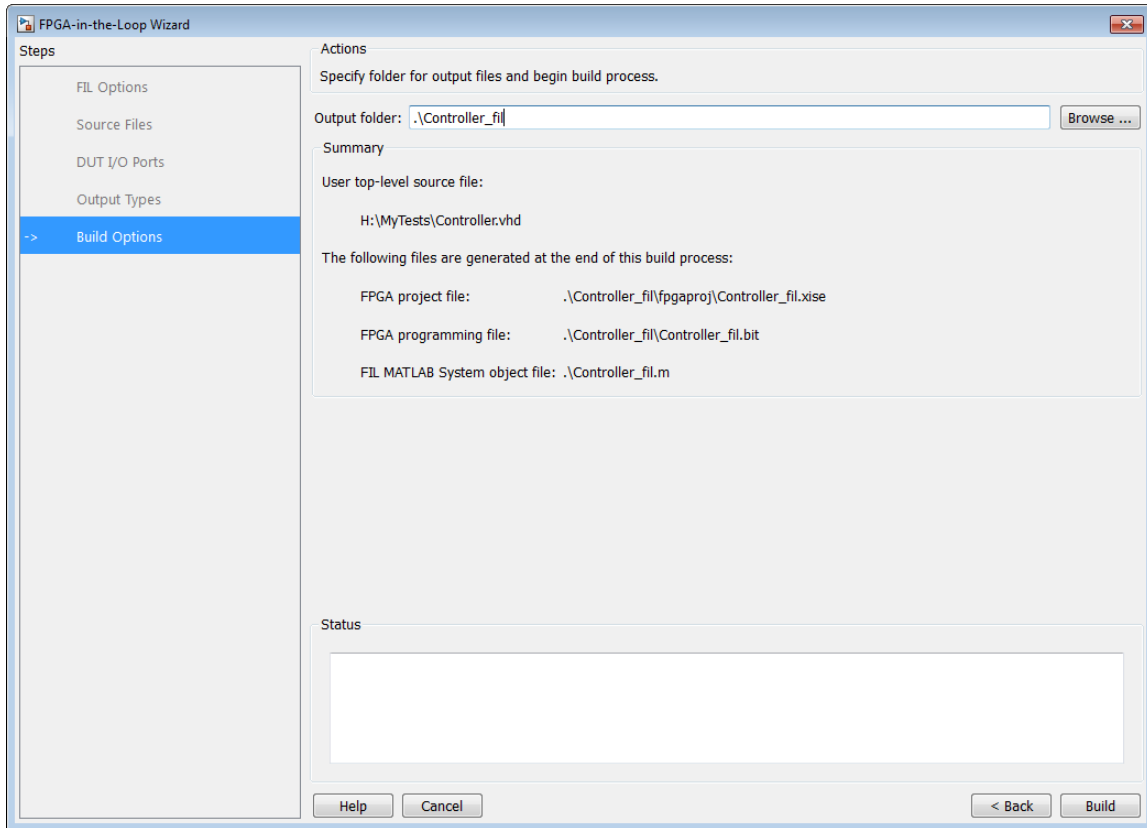

(This page is for FIL System object. For Simulink, see “Step 7: Specify Build Options for FIL Block” on page 11-10.)

In the **Build Options** page:

- Specify the folder for the output files. You can use the default option. Usually the default is a subfolder named after the top-level module, located under the current folder.
- The **Summary** displays the locations of the ISE project file and the FPGA programming file. You may need those two files for advanced operations on the FIL block mask.

Step 8: Initiate Build

Click **Build** to initiate FIL System object generation.

1 The FIL wizard generates the following files:

- In the `./toplevel_fil/` folder, a MATLAB function named `toplevel_programFPGA.m`, where `toplevel` is the name of the HDL top level. This file contains the code to download the FPGA programming file to the FPGA.

```
function topLevel_programFPGA

    %Load the bitstream in the FPGA
    filProgramFPGA('Xilinx', '/dir/mybitstream.bit', 1);
end
```

- A MATLAB file named `toplevel_fil.m`, where `toplevel` is the name of the HDL top level. This file contains a class definition derived from `hdlverifier.FILSimulation` and initializes the private properties. This file is located in the current folder.

The following is a sample of a class definition file generated using the FIL wizard from a DUT named `fft8`.

```
classdef fft8_fil < hdlverifier.FILSimulation
%fft8_fil is a filWizard generated class used for FPGA-In-the-Loop
% simulation with the 'fft8' DUT.
% fft8_fil connects MATLAB with a FPGA and cosimulate with it by
% writing inputs in the FPGA and reading outputs from the FPGA.
%
% MYFIL = fft8_fil
%
% Step method syntax:
%
% [out1, out2, ...] = step(MYFIL, in1, in2, ...) connect to the FPGA,
% write in1, in2, ... to the FPGA and read out1, out2, ... from
% the FPGA
%
% fft8_fil methods:
%
% step          - See above description for use of this method
% release       - Allow property value and input characteristics changes, and
%                 release connection to FPGA board
% clone         - Create fft8_fil object with same property values
% isLocked      - Locked status (logical)
% programFPGA   - Load the programming file in the FPGA
%
% fft8_fil properties:
%
% DUTName       - DUT top level name
% InputSignals  - Input paths in the HDL code
% InputBitWidths - Width in bit of the inputs
% OutputSignals - Output paths in the HDL code
```

```

% OutputBitWidths          - Width in bit of the outputs
% OutputDataTypes         - Data type of the outputs
% OutputSigned            - Sign of the outputs
% OutputFractionLengths  - Fraction lengths of the outputs
% OutputDownsampling     - Downsampling factor and phase of the outputs
% OverclockingFactor     - Overclocking factor of the hardware
% SourceFrameSize        - Frame size of the source (only for HDL source block)
% Connection             - Parameters for the connection with the board
% FPGAVendor             - Name of the FPGA chip vendor
% FPGABoard              - Name of the FPGA board
% FPGAProgrammingFile    - Path of the Programming file for the FPGA
% ScanChainPosition      - Position of the FPGA in the JTAG scan chain
%
% File Name: fft8_fil.m
% Created: 26-Apr-2012 18:18:06
%
% Generated by FIL Wizard

properties (Nontunable)
    DUTName = 'fft8';
end

methods
    function obj = fft8_fil

        %THE FOLLOWING PROTECTED PROPERTIES ARE SPECIFIC TO THE HW DUT
        %AND MUST NOT BE EDITED (RERUN THE FIL WIZARD TO CHANGE THEM)
        obj.InputSignals = char('Xin_re','Xin_im');
        obj.InputBitWidths = [10,10];
        obj.OutputSignals = char('Xout_re','Xout_im');
        obj.OutputBitWidths = [13,13];
        obj.Connection = char('UDP','192.168.0.2','00-0A-35-02-21-8A');
        obj.FPGAVendor = 'Xilinx';
        obj.FPGABoard = 'XUP Atlys Spartan-6 development board';
        obj.ScanChainPosition = 1 ;

        %THE FOLLOWING PUBLIC PROPERTIES ARE RELATED TO THE SIMULATION
        %AND CAN BE EDITED WITHOUT RERUNING THE FIL WIZARD
        obj.OutputSigned = [true,true];
        obj.OutputDataTypes = char('fixedpoint','fixedpoint');
        obj.OutputFractionLengths = [9,9];
        obj.OutputDownsampling = [1,0];
        obj.OverclockingFactor = 1;
        obj.SourceFrameSize = 1;
        obj.FPGAProgrammingFile = 'S:\MATLAB\demo\fft8_fil\fft8_fil.bit';
    end
end
end

```

2 The FIL wizard opens a command window.

- In this window, the FPGA design software performs synthesis, fit, PAR, and FPGA programming file generation.
- When the process completes, a message in the command window prompts you to close the window.

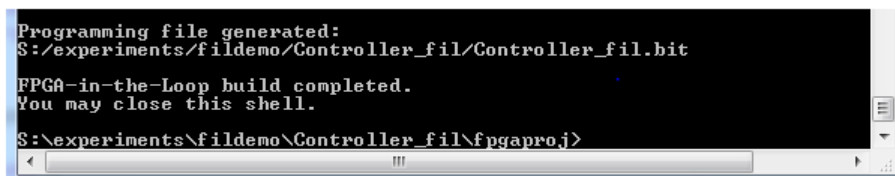

```
Programming file generated:  
S:/experiments/fildemo/Controller_fil/Controller_fil.bit  
FPGA-in-the-Loop build completed.  
You may close this shell.  
S:\experiments\fildemo\Controller_fil\fpgaproj>
```

When these steps are completed, see “Perform FPGA-in-the-Loop Simulation” on page 11-25.

Perform FPGA-in-the-Loop Simulation

In this section...

“FIL Block Setup and Simulation” on page 11-25

“FIL System Object Setup and Simulation” on page 11-29

FIL Block Setup and Simulation

- “Insert FIL Block Into Model” on page 11-25
- “Adjust FIL Block Settings” on page 11-25
- “Load Programming File onto FPGA” on page 11-25
- “Run Simulation” on page 11-29

Insert FIL Block Into Model

In your model, replace the DUT subsystem with the FIL block generated in the new model. Save the model under a different name. You can then use the original model as a reference model.

Adjust FIL Block Settings

If you generated your FIL block from the HDL workflow advisor, it is unlikely that you need to adjust any settings on the FIL block. If you generated your FIL block using the FIL wizard, you may want to adjust some settings. For instructions on adjusting the FIL block settings, see FIL Simulation.

Load Programming File onto FPGA

Altera Board with Linux

If you are using the Altera board and a Linux distribution supported by Altera, read the “USB-Blaster Download Cable User Guide” provided on the Altera website: http://www.altera.com/literature/ug/ug_usb_blstr.pdf. Specifically, to program the bit file you must be a superuser. The user guide provides instructions for making a one-time modification to a rules file to give you that permission.

Ensure that your FPGA development board is set up, turned on, and connected to your machine using a JTAG cable. Programming uses the JTAG interface, even if you select a different connection for simulation.

Perform the following steps to program the FPGA:

- 1 Double-click the FIL block in your Simulink model to open the block mask.
- 2 On the **Main** tab, click **Load** to download the programming file to the FPGA via the JTAG cable.

The load process can take from a few minutes to several minutes or longer, depending on how large the subsystem is. Sometimes, the process can take an hour and a half or longer for large subsystems.

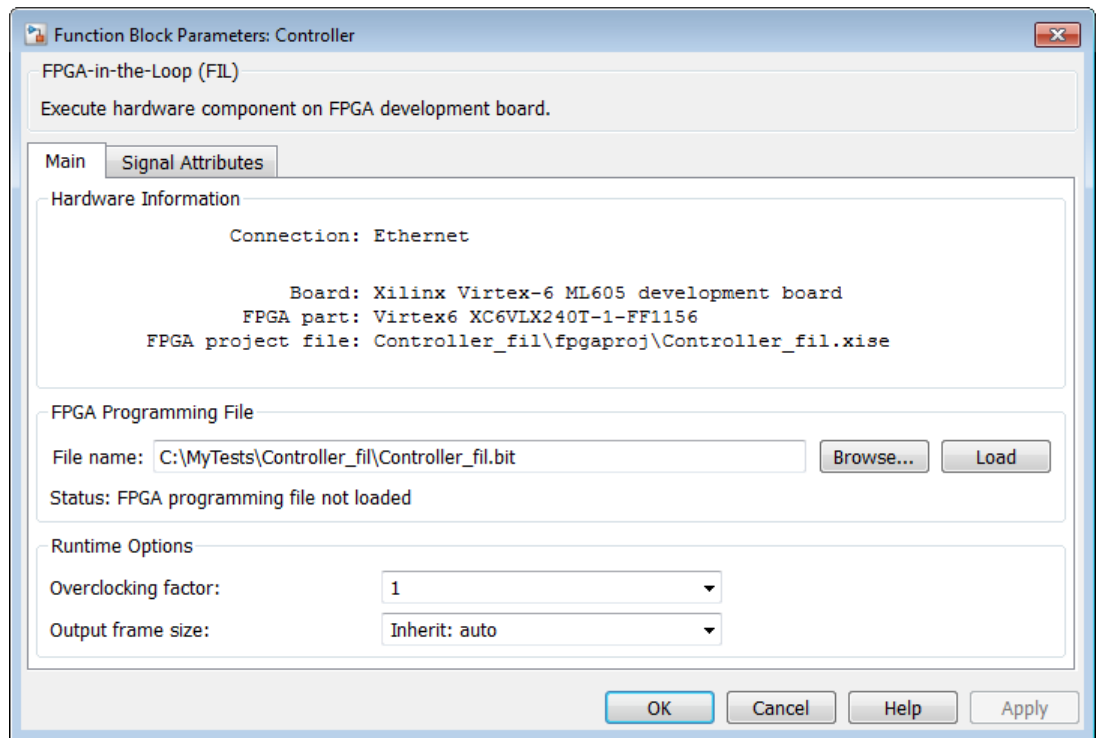

- 3 A message window indicates when the FPGA programming file has loaded as expected. Click **OK**.

Ethernet Connection

If you are using an Ethernet connection, you can test if the FPGA board is connected to your host computer through the ping test. Open a command-line window, and enter the following command:

```
> ping 192.168.0.2
```

If you changed the board IP address when you set up the network adapter, replace 192.168.0.2 with your board IP address. If the Gigabit Ethernet connection has been set up, you receive the ping reply from the FPGA development board.

PCI Express Connection

If you are using a PCI Express connection, after you program the FPGA, restart the host computer. The host computer cannot detect the new PCI Express device without a restart.

If you are using a PCI Express connection with an Altera board, the board receives power through the host computer. If the host computer turns off, the FPGA loses your programmed design. To restart without losing power to the board, from the **Start** menu, select **Restart**. To avoid disrupting a long simulation, disable the **Sleep** settings for the host computer.

After the restart, check the **Device Manager** in Windows. A new FPGA-in-the-loop device appears in the list.

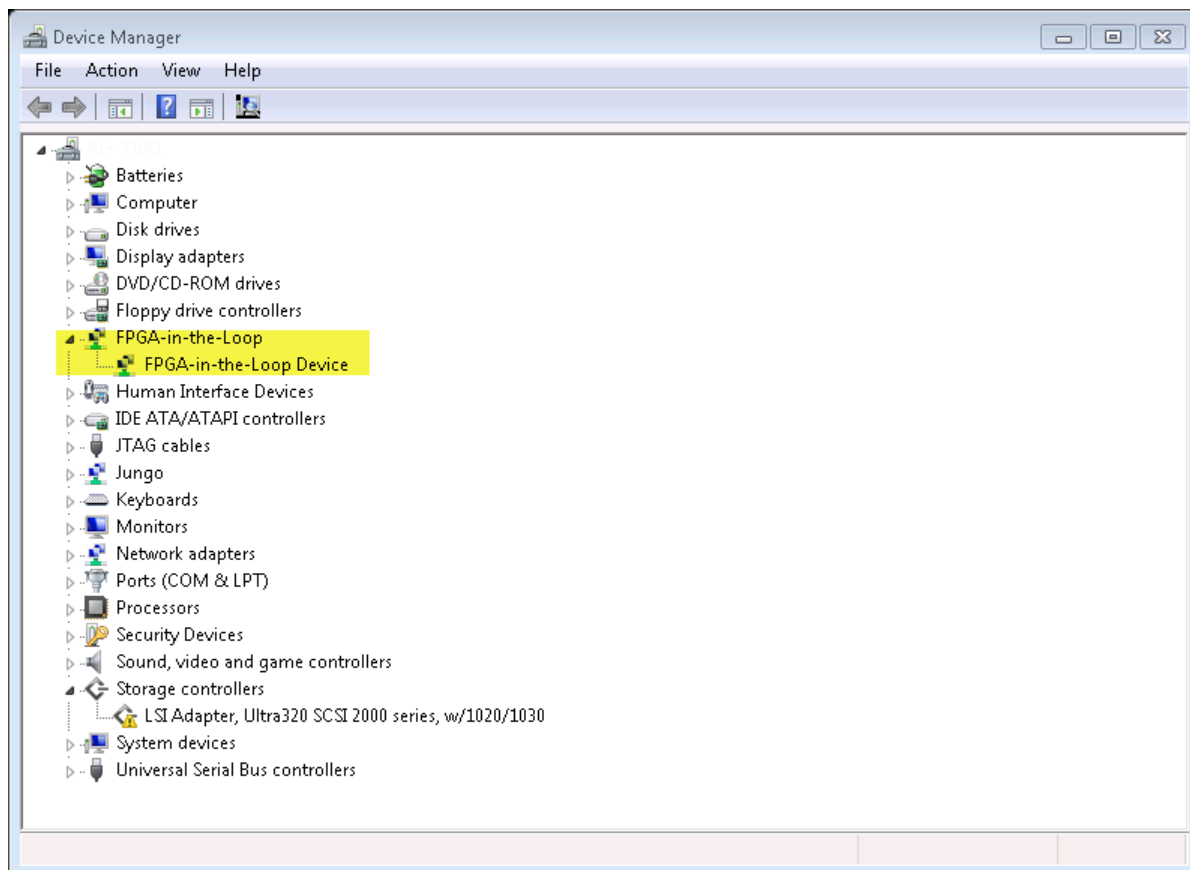

Altera Board Instructions for Linux

On Linux hosts, you often must be a superuser to program the bit file onto Altera boards. This requirement can restrict testing on these boards. However, there is a way to work around the superuser requirement.

Fix the device permission issue for Altera bitstream programming under Debian[®] 5 by creating or modifying a rules file. This solution is a one time file modification that requires SUPERUSER privileges.

- Option 1: Create a rules file (e.g., `92-altera.rules`) under `/etc/udev/rules.d/` with the following contents:

```
# Altera USB-Blaster

ATTRS{idVendor}=="09fb", ATTRS{idProduct}=="6001", GROUP="users"
```

- Option 2: Add the following lines to an existing rule file under `/etc/udev/rules.d/`

```
# Altera USB-Blaster

ATTRS{idVendor}=="09fb", ATTRS{idProduct}=="6001", GROUP="users"
```

Run Simulation

In Simulink, click **Simulation > Run** or the Run Simulation button in your Simulink model window. The results of the FIL simulation should match the results of the Simulink reference model or of the original HDL code.

Note: RAM Initialization: Simulink starts from time 0 every time, which means the RAM in a Simulink model is initialized to zero for each run. However, this assumption is not true in hardware. RAM in the FPGA holds its value from the end of one simulation to the start of the next. If you have RAM in your design, the first simulation matches Simulink, but subsequent runs may not match. The workaround is to reload the FPGA bitstream before rerunning the simulation. To reload the bitstream, click the **Load** on the FIL block mask.

FIL System Object Setup and Simulation

- “Generate System Object” on page 11-29
- “Adjust System Object Parameters” on page 11-30
- “Load Programming Files onto FPGA” on page 11-30
- “Run Simulation” on page 11-30

Generate System Object

Create a custom `FILSimulation` System object from the class definition file derived using the FIL wizard. You can instantiate the class using the following constructor:

```
MYFIL = toplevel_fil
```

This code snippet creates an instance of the class and initializes all properties.

Adjust System Object Parameters

You can adjust any property with write permission using one of these methods:

- Change the property with the set method:

```
MYFIL.set('FPGAProgrammingFile','c:\work\filfiles')
```

- Set the property directly:

```
MYFIL.FPGAProgrammingFile='c:\work\filfiles'
```

- Edit *toplevel_fil.m* directly. If you edit the .m file, instantiate the object in the workspace again, if you had done so previously.

Load Programming Files onto FPGA

You can program the FPGA using either the `programFPGA` function, or the `programFPGA` method of the FIL System object. Reminder: if you have not yet performed the “Guided Hardware Setup” on page 10-8, do so now before loading the programming files.

- `programFPGA` function:

```
./toplevel_fil/toplevel_programFPGA
```

- `programFPGA` method:

```
MYFIL.programFPGA
```

MYFIL is an instance of a `FILSimulation` object.

Run Simulation

- 1 Use the System object in your MATLAB code.
- 2 Run your MATLAB code as you normally would. Make sure that you have performed the “Guided Hardware Setup” on page 10-8 before beginning.

The first call to the `step` method establishes communication with the FPGA board.

See the example FPGA-in-the-Loop simulation using MATLAB System Object for a full demonstration.

FIL Using HDL Coder HDL Workflow Advisor

- “FIL Simulation with HDL Workflow Advisor for Simulink” on page 12-2
- “FIL Simulation with HDL Workflow Advisor for MATLAB” on page 12-10

FIL Simulation with HDL Workflow Advisor for Simulink

In this section...

“Step 1: Start HDL Workflow Advisor” on page 12-2

“Step 2: Set Target” on page 12-2

“Step 3: Prepare Model for HDL Code Generation” on page 12-3

“Step 4: HDL Code Generation” on page 12-3

“Step 5: Set FPGA-in-the-Loop Options” on page 12-3

“Step 6: Generate FPGA Programming File and FPGA-in-the-Loop Model” on page 12-7

“Step 7: Load Programming File onto FPGA” on page 12-9

“Step 8: Run Simulation” on page 12-9

Step 1: Start HDL Workflow Advisor

Follow instructions for invoking the HDL Workflow Advisor. See “Open the HDL Workflow Advisor”.

Note: You must have an HDL Coder license to generate HDL code using the HDL Workflow Advisor.

Step 2: Set Target

At step 1, **Set Target**, click **1.1 Set Target Device and Synthesis Workflow** and do the following:

- 1 Select **FPGA-in-the-Loop** from the pull-down list at **Target Workflow**.
- 2 Under **Target Platform**, select a development board from the pull-down list. **Family**, **Device**, **Package**, and **Speed** are filled in by the HDL Workflow Advisor. If you have not yet downloaded an HDL Verifier FPGA board support package, select **Get more boards**. Then return to this step after you have downloaded an FPGA board support package.
- 3 For **Folder**, enter the folder name to save the project files into. The default is `hdl_prj` under the current working folder.

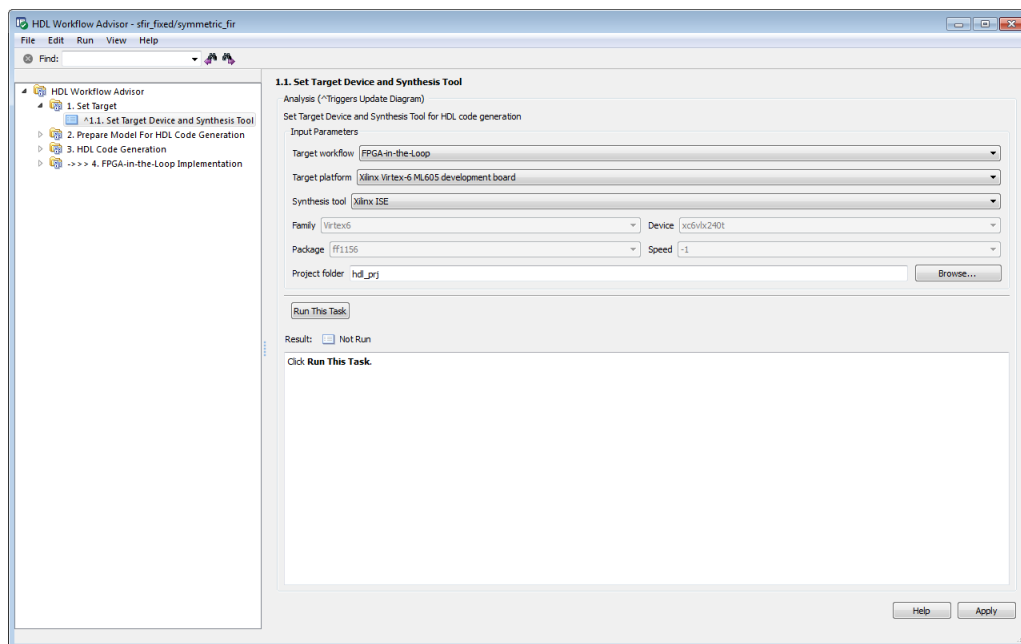

Step 3: Prepare Model for HDL Code Generation

At step 2, **Prepare Model for HDL Code Generation**, perform steps 2.1–2.4 as described in “Prepare Model For HDL Code Generation Overview”.

In addition, perform step 2.5 **Check FPGA-in-the-Loop Compatibility** to verify that the model is compatible with FIL.

Step 4: HDL Code Generation

At step 3, **HDL Code Generation**, perform steps 3.1 and 3.2 as described in “HDL Code Generation Overview”.

Step 5: Set FPGA-in-the-Loop Options

At step 4.1, **Set FPGA-in-the-Loop Options**, change these options if necessary:

- **FPGA-in-the-Loop Connection:** FIL simulation connection method. The options in the drop-down menu update depending on the connection methods supported

for the target board you selected. If the target board and HDL Verifier support the connection, you can choose Ethernet, JTAG, or PCI Express.

- **Board Address:**

When you select an Ethernet connection, you can adjust the board IP and MAC addresses, if necessary.

Option	Instructions
Board IP address	<p>Use this option for setting the IP address of the board if it is not the default IP address (192.168.0.2).</p> <p>If the default board IP address (192.168.0.2) is in use by another device, or you need a different subnet, change the Board IP address according to the following guidelines:</p> <ul style="list-style-type: none"> • The subnet address, typically the first three bytes of board IP address, must be the same as the subnet of the host IP address. • The last byte of the board IP address must be different from the last byte of the host IP address. • The board IP address must not conflict with the IP addresses of other computers. <p>For example, if the host IP address is 192.168.8.2, then you can use 192.168.8.3, if available.</p>
Board MAC address	<p>Under most circumstances, you do not need to change the board MAC address. If you connect more than one FPGA development board to a single host computer, change the board MAC address for any additional boards so that each address is unique. You must have a separate NIC for each board.</p> <p>To change the Board MAC address, click in the Board MAC address field. Specify an address that is different from that belonging to any other device attached to your computer. To obtain the Board MAC address for a specific FPGA development board, refer to the label affixed to the board or consult the product documentation.</p>

- **Specify additional source files for the HDL design:**

Indicate additional source files for the DUT using **Add**. To (optionally) display the full paths to the source files, check the box titled **Show full paths to source files**. The HDL Workflow Advisor attempts to identify the source file type. If the file type is incorrect, you can change it by selecting from the **File Type** drop-down list.

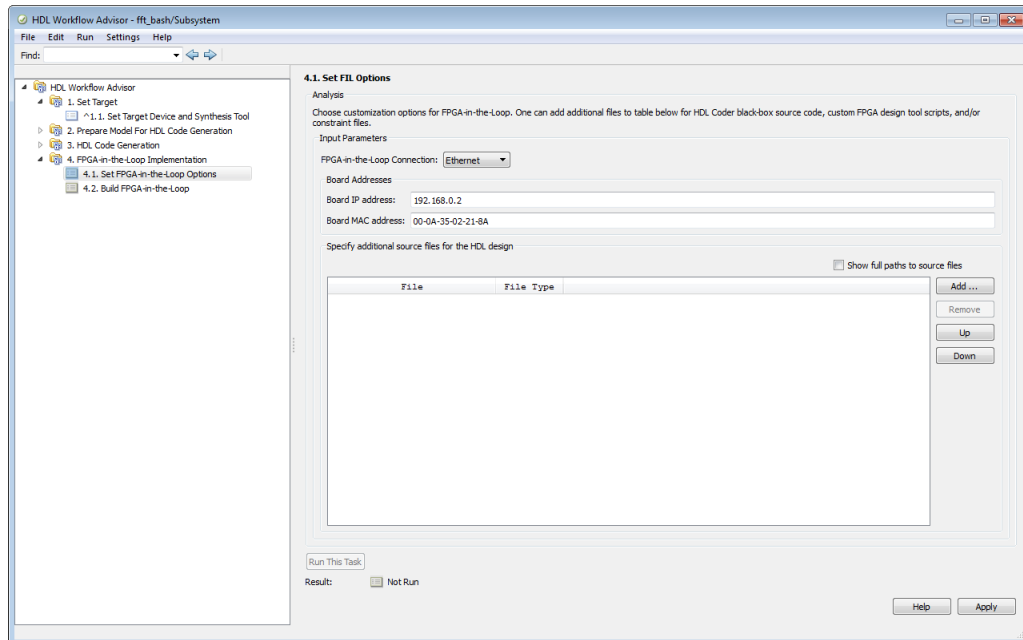

FIL Over Ethernet

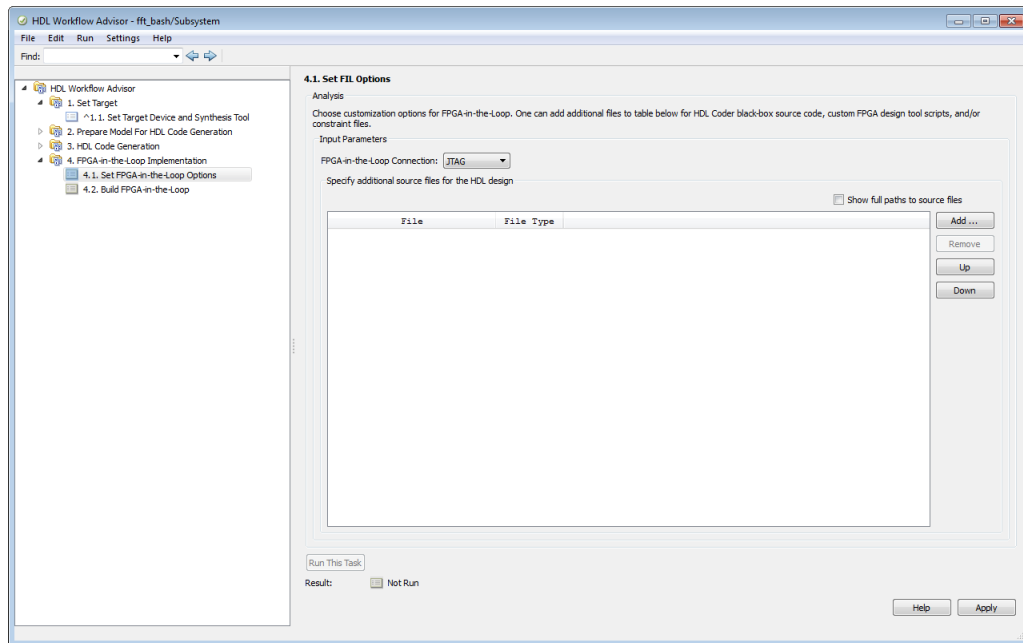

FIL Over JTAG

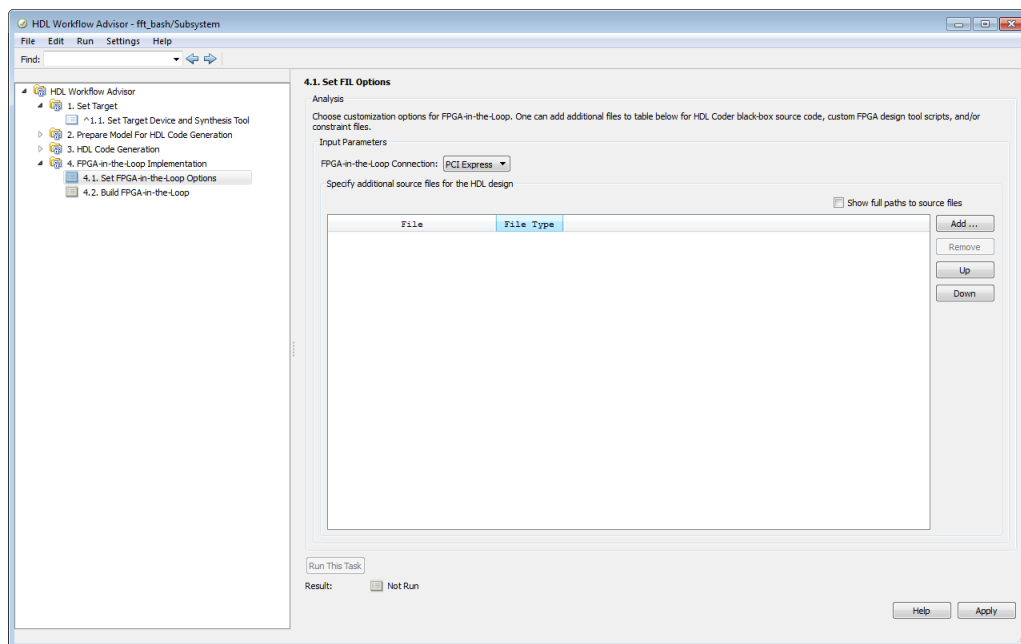

FIL Over PCI Express

Step 6: Generate FPGA Programming File and FPGA-in-the-Loop Model

At step 4.2, **Build FPGA-in-the-Loop**, click **Run this task**.

During the build process, the following actions occur:

- The HDL Workflow Advisor generates a FIL block named after the top-level module and places it in a new model. The next figure shows an example of the new model containing the FIL block.

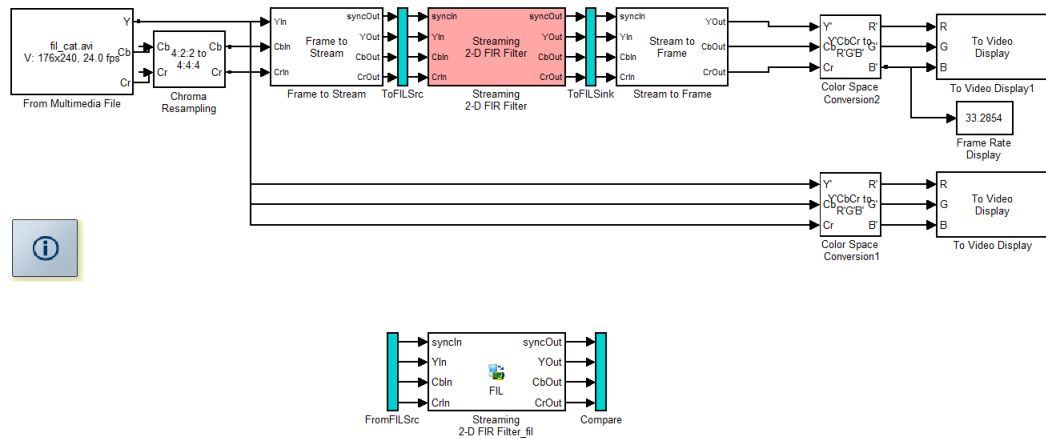

- After new model generation, the HDL Workflow Advisor opens a command window:
 - In this window, the FPGA design software performs synthesis, fit, PAR, and FPGA programming file generation.
 - When the process completes, a message in the command window prompts you to close the window.

```

Programming file generated:
$:/experiments/fildemo/Controller_fil/Controller_fil.bit

FPGA-in-the-Loop build completed.
You may close this shell.

$:/experiments/fildemo/Controller_fil/fpgapro.j>
    
```

- The HDL Workflow Advisor builds a test bench model around the generated FIL block.

Step 7: Load Programming File onto FPGA

Ensure your FPGA development board is set up, powered on, and connected to your machine as directed by the board manufacturer documentation. Then, perform the following steps to program the FPGA:

- 1 Double-click the FIL block in your Simulink model to open the block mask.
- 2 On the **Main** tab, click **Load** to download the programming file to the FPGA.

The load process may take several minutes, depending on how large the subsystem is. For very large subsystems, the process can take an hour or longer.

For further troubleshooting tips, see “Load Programming File onto FPGA” on page 11-25.

Step 8: Run Simulation

In Simulink, click **Simulation > Run** or the Run Simulation button in your Simulink model window. The results of the FIL simulation should match those of the Simulink reference model or of the original HDL code.

Note: Regarding initialization: Simulink starts from time 0 every time, which means the RAM in Simulink is initialized to zero. However, this is not true in hardware. If you have RAM in your design, the first simulation will match Simulink, but any subsequent runs may not match.

The workaround is to reload the FPGA bitstream before re-running the simulation. To do this, click **Load** on the FIL block mask.

FIL Simulation with HDL Workflow Advisor for MATLAB

In this section...

“Step 1: Start HDL Workflow Advisor” on page 12-10

“Step 2: Select Target” on page 12-10

“Step 3: Select Workflow” on page 12-10

“Step 4: Select FPGA-in-the-Loop Options” on page 12-10

“Step 5: Generate FPGA Programming File and Run Simulation” on page 12-15

Step 1: Start HDL Workflow Advisor

Follow instructions for invoking the HDL Workflow Advisor in MATLAB. See “Open the HDL Workflow Advisor”.

Note: You must have an HDL Coder license to generate HDL code using the HDL Workflow Advisor.

Step 2: Select Target

Under **Select Code Generation Target**, make sure **Workflow** is set to **Generic ASIC/FPGA**.

Step 3: Select Workflow

Under **HDL Verification**, select **Verify with FPGA-in-the-Loop**.

Step 4: Select FPGA-in-the-Loop Options

- 1 **Generate FPGA-in-the-Loop test bench:** Select this option to generate a test bench for simulation with FPGA-in-the-loop.
- 2 **Log outputs for comparison plots:** This optional selection lets you log and plot the outputs of the reference design function and the FPGA.
- 3 **Board Name:** Select one of the FPGA development boards. If you have not yet downloaded an HDL Verifier FPGA board support package, select **Get more**

boards. Then return to this step after you have downloaded an FPGA board support package.

- 4 **FPGA-in-the-Loop Connection:** FIL simulation connection method. The options in the drop-down menu update depending on the connection methods supported for the target board you selected. If the target board and HDL Verifier support the connection, you can choose **Ethernet**, **JTAG**, or **PCI Express**.
- 5 **Board IP Address and Board MAC Address:**

When you select an Ethernet connection, you can adjust the board IP and MAC addresses, if necessary.

Option	Instructions
Board IP address	<p>Use this option for setting the IP address of the board if it is not the default IP address (192.168.0.2).</p> <p>If the default board IP address (192.168.0.2) is in use by another device, or you need a different subnet, change the Board IP address according to the following guidelines:</p> <ul style="list-style-type: none"> • The subnet address, typically the first three bytes of board IP address, must be the same as the subnet of the host IP address. • The last byte of the board IP address must be different from the last byte of the host IP address. • The board IP address must not conflict with the IP addresses of other computers. <p>For example, if the host IP address is 192.168.8.2, then you can use 192.168.8.3, if available.</p>
Board MAC address	<p>Under most circumstances, you do not need to change the board MAC address. If you connect more than one FPGA development board to a single host computer, change the board MAC address for any additional boards so that each address is unique. You must have a separate NIC for each board.</p> <p>To change the Board MAC address, click in the Board MAC address field. Specify an address that is different from that belonging to any other device attached to your</p>

Option	Instructions
	computer. To obtain the Board MAC address for a specific FPGA development board, refer to the label affixed to the board or consult the product documentation.

6 Additional files

Enter the names of any additional source files for the DUT. If you have more than one additional source file, use the ... button to add more.

7 FPGA-in-the-Loop Test Bench Simulation Settings:

If you want the HDL Workflow Advisor to open the FIL simulation, check the box for **Simulate generated FPGA-in-the-Loop test bench**.

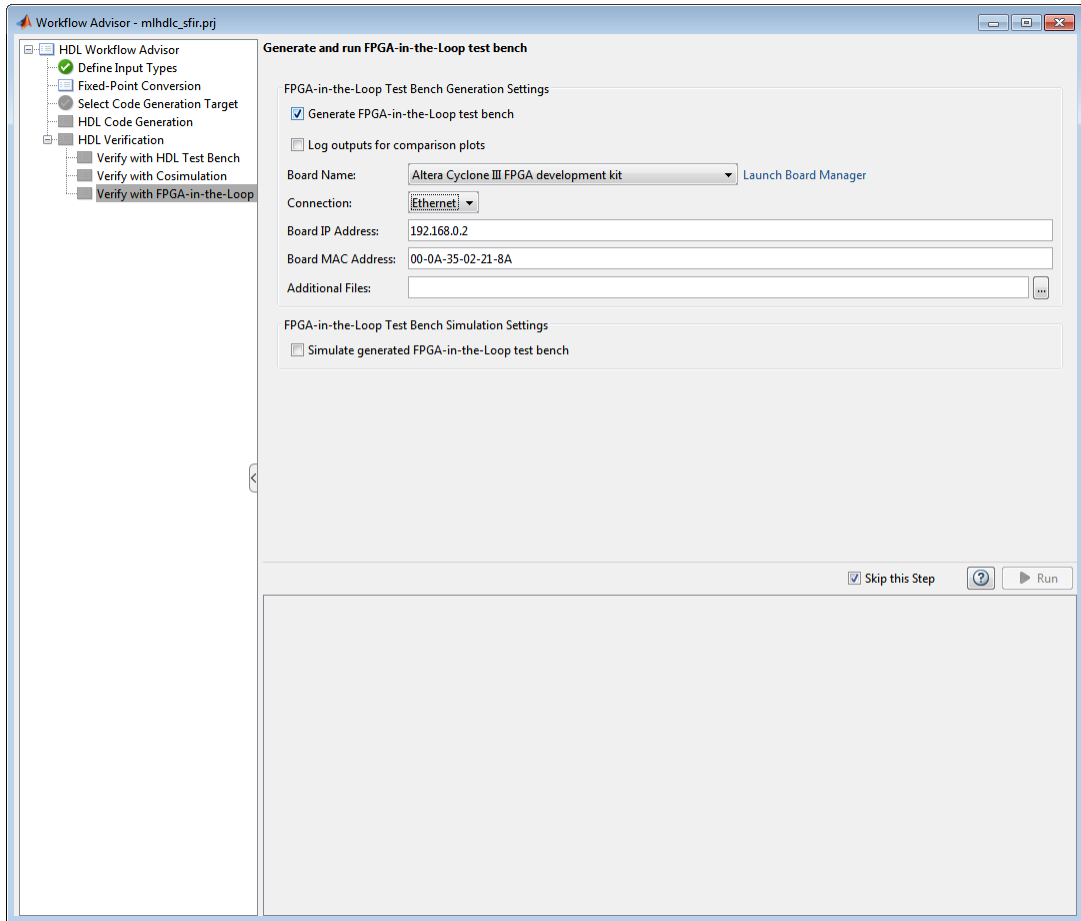

FIL Over Ethernet

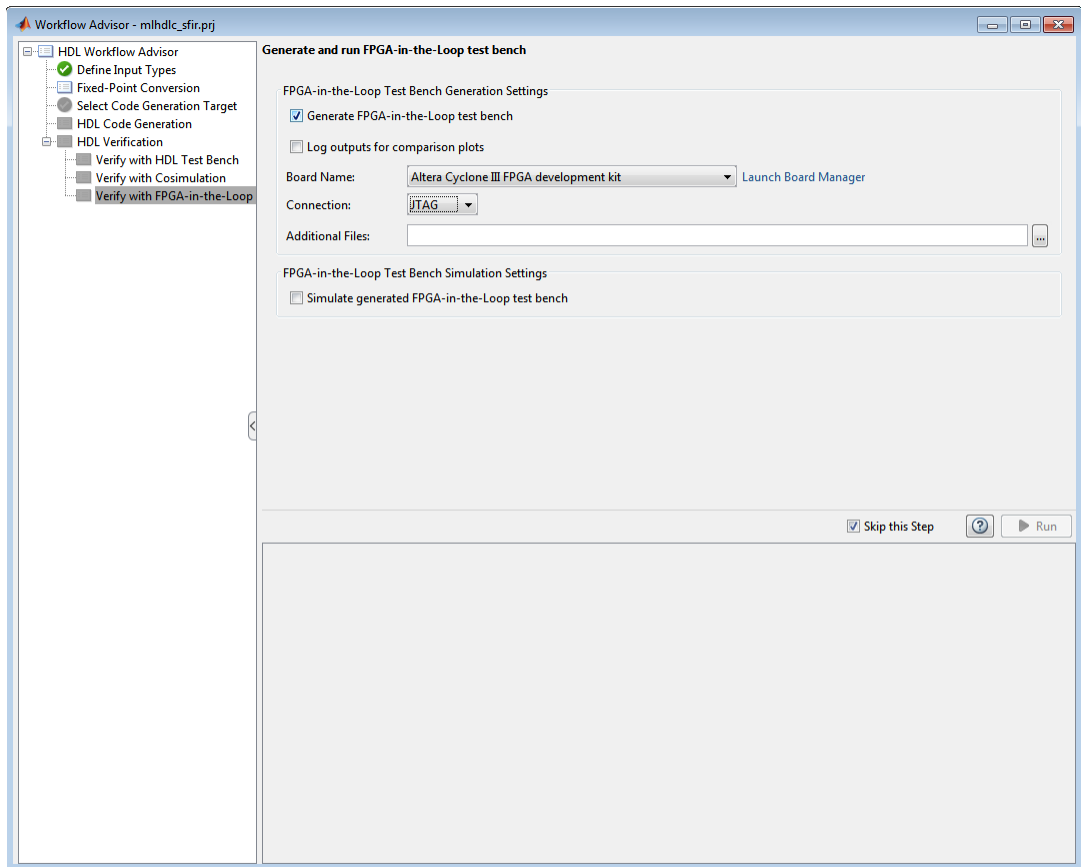

FIL Over JTAG

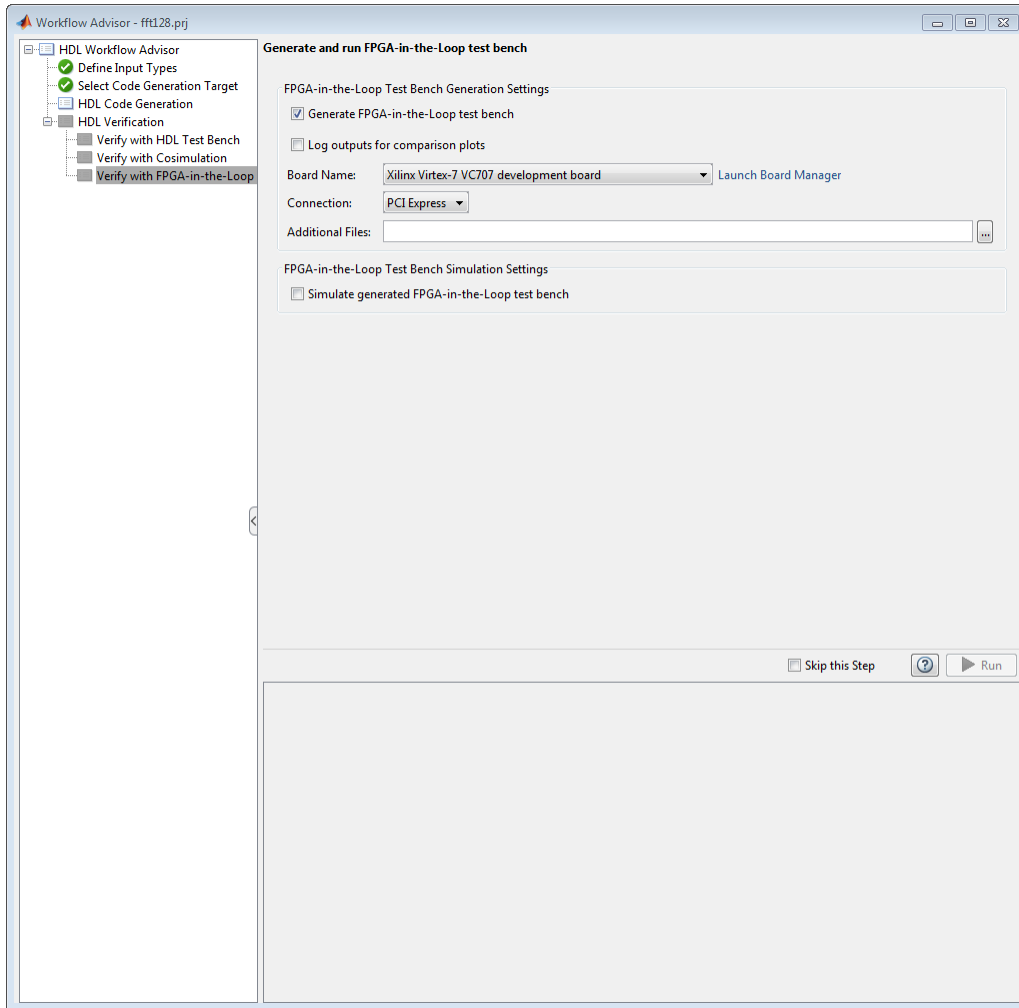

FIL Over PCI Express

Step 5: Generate FPGA Programming File and Run Simulation

Click **Run**. If you have not yet run the previous tasks, right-click **Verify with FPGA-in-the-Loop** and select **Run to Selected Task**.

If you selected **Simulate generated FPGA-in-the-Loop test bench**, this step loads the FPGA programming file onto the FPGA, and runs the automatically generated test bench with FPGA-in-the-loop.

If you did not select **Simulate generated FPGA-in-the-Loop test bench**, load the FPGA programming file manually. You can program the FPGA using either the `programFPGA` function or the `programFPGA` method. Reminder: if you have not yet performed the “Guided Hardware Setup” on page 10-8 or “Set Up FPGA Design Software Tools” on page 10-7, do so now before loading the programming files.

- `programFPGA` function:

```
./toplevel_fil/toplevel_programFPGA
```

- `programFPGA` method:

```
MYFIL.programFPGA
```

Run your MATLAB code, including the System object as you normally would.

The first call to the step method establishes communication with the FPGA board.

Troubleshooting FPGA-in-the-Loop

Troubleshooting FIL

If you get a message or error at any time during the FIL process (from generating the FIL block to running the simulation), consult one of the following tables for a possible reason and solution.

Message or Error	Reason	Fix
<p>Design does not meet timing goals (this message is generated from the FPGA design software)</p>	<p>The design does not meet timing goals and the software was unable to create the programming file.</p>	<p>Change some part of your design or use a different development board.</p>
<p>Failed to load bitstream</p>	<p>The default libusb shipped with the Debian client is not compatible with iMPACT™.</p>	<p>Consult Xilinx user documentation for Linux distribution compatibility of ISE tools.</p>
<p>RAM in design does not match up to Simulink RAM after first simulation run</p>	<p>Simulink starts from time 0 every time, which means the RAM in Simulink is initialized to zero. However, this is not true in hardware. If you have RAM in your design, the first simulation will match Simulink, but any subsequent runs may not match.</p>	<p>The workaround is to reload the FPGA before re-running the simulation.</p>
<p>Did not receive data from attached hardware (Ethernet connection)</p>	<p>The connectivity between the host and FPGA development board was lost during the simulation. This error could be caused by a bad network interface card (NIC), bad cable, or loss of power. It also could be caused by an issue with the operating system IP stack where the IP address / MAC address binding is being refreshed, interfering with the transmission of data from the development board to the host.</p>	<p>Check the cables and power so that connectivity can be re-established.</p> <p>You can avoid the IP address / MAC address refresh issue by setting a static entry in the ARP cache (the table that holds the address bindings). You will need to gather the IP address and MAC address by examining the Hardware Information section of the FIL block mask. The following examples will assume the default values of 192.168.0.2 for the IP address and 00-0A-35-02-21-8A for the MAC address.</p> <p>For Windows: <i>With system administrator privileges</i>, execute the following in a command shell:</p> <pre>cmd> arp -s 192.168.0.2 00-0A-35-02-21-8A</pre> <p>To confirm that the operation outcome was as you expected, examine the table and verify the output shows a <i>static</i> entry type:</p> <pre>cmd> arp -a 192.168.0.2</pre> <pre>Interface: 192.168.0.8 -.-.- 0x16 Internet Address Physical Address Type 192.168.0.2 00-0a-35-02-21-8a static</pre>

FIL Examples

- “Verify HDL Implementation of PID Controller Using FPGA-in-the-Loop” on page 14-2
- “Verify Digital Up-Converter Using FPGA-in-the-Loop” on page 14-24

Verify HDL Implementation of PID Controller Using FPGA-in-the-Loop

This example shows you how to set up an FPGA-in-the-Loop (FIL) application using HDL Verifier™. The application uses Simulink® and an FPGA development board to verify the HDL implementation of a proportional-integral-derivative (PID) controller. In this example, Simulink generates the desired position of a motor and simulates the motor controlled by this PID controller.

Requirements and Prerequisites

Products required for this example:

- MATLAB
- Simulink
- Fixed-Point Designer
- HDL Verifier
- FPGA design software (Xilinx® ISE® design suite, or Xilinx® Vivado® design suite, or Altera® Quartus® II design software)
- One of the supported FPGA development boards and accessories
- For connection using Ethernet: Gigabit Ethernet Adapter installed on host computer, Gigabit Ethernet crossover cable
- For connection using JTAG: USB Blaster I or II cable and driver for Altera FPGA boards. Digilent® JTAG cable and driver for Xilinx FPGA boards.
- For connection using PCI Express®: FPGA board installed into PCI Express slot of host computer.

Prerequisites:

MATLAB® and FPGA design software can either be locally installed on your computer or on a network accessible device. If you use software from the network you will need a second network adapter installed in your computer to provide a private network to the FPGA development board. Consult the hardware and networking guides for your computer to learn how to install the network adapter.

Step 1: Set Up FPGA Development Board

Skip this step and step 2 if you are using PCI Express connection for simulation. If you have not set up your PCI Express connection, use the support package installation software to guide you through PCI Express setup.

Use the following steps to set up your FPGA development board.

- 1 Make sure that the power switch remains **OFF**.
- 2 Connect the AC power cord to the power plug. Plug the power supply adapter cable into the FPGA development board.
- 3 Connect the Ethernet connector on the FPGA development board directly to the Ethernet adapter on your computer using the crossover Ethernet cable.
- 4 Use the JTAG download cable to connect the FPGA development board with the computer.
- 5 Make sure that all jumpers on the FPGA development board are in the factory default position.

Step 2: Set Up Host Computer-Board Connection

Skip this step if you are using JTAG connection for simulation. For connection with Ethernet, you must have a Gigabit Ethernet network adapter on your computer to run this example.

On Windows® 7, do the following steps:

- 1 Open the **Control Panel**.
- 2 Type **View network connections** in the search bar. Select **View network connections** in the search results.
- 3 Right click the connection icon to your FPGA development board and select **Properties** from the pop-up menu.
- 4 Under **This connection uses the following items**, select **Internet Protocol Version 4 (TCP/IPv4)** and click **Properties**.
- 5 Select **Use the following IP address**:. Set **IP address** to 192.168.0.1. If this address is in use by another computer on your network, change it to any available IP address on this subnet, such as 192.168.0.100. This is your host computer address. Set the **Subnet mask** to 255.255.255.0. Your TCP/IP properties should now look the same as in the following figure:

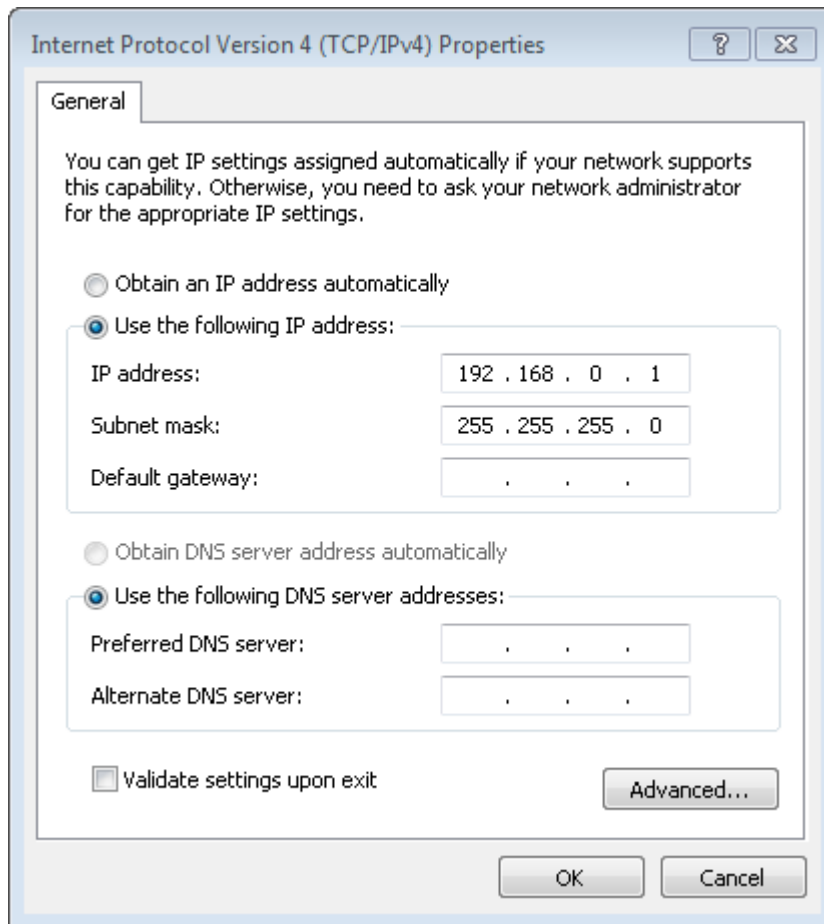

On Windows® Vista, do the following steps:

- 1 Open the **Control Panel**.
- 2 Click **Network and Sharing Center**, and then click **Manage network connections**.
- 3 Right click the connection icon to your FPGA development board and select **Properties** from the pop-up menu.
- 4 Under **This connection uses the following items**, select **Internet Protocol Version 4 (TCP/IPv4)** and click **Properties**.

- 5 Select **Use the following IP address:**. Set **IP address** to **192.168.0.1**. If this address is in use by another computer on your network, change it to any available IP address on this subnet, such as 192.168.0.100. This is your host computer address. Set the **Subnet mask** to 255.255.255.0.

On Windows XP®, do the following steps:

- 1 Open the **Control Panel**.
- 2 Open **Network connections**.
- 3 Right click the connection icon to your FPGA development board and select **Properties** from the pop-up menu.
- 4 Under **This connection uses the following items**, select **Internet Protocol (TCP/IP)** and click **Properties**.
- 5 Select **Use the following IP address:**. Set **IP address** to 192.168.0.1. If this address is in use by another computer on your network, change it to any available IP address on this subnet, such as 192.168.0.100. This is your host computer address. Set the Subnet mask to 255.255.255.0.

On Linux®:

Use the **ifconfig** command to set up your local address. For example:

```
% ifconfig eth1 192.168.0.1
```

In this example, eth1 is the second Ethernet adapter on the Linux computer. Check your system to determine which Ethernet adapter is connected to the FPGA development board. The above command sets the local IP address to 192.168.0.1. If this address is in use by another computer on your network, change it to any available IP address on this subnet, such as 192.168.0.100.

Step 3: Prepare Example Resources

Set up an examples folder, copy example files, set up access to FPGA design software, and open model.

1. Create a folder outside the scope of your MATLAB installation folder into which you can copy the example files. The folder must be writable. This example assumes that the folder is located at C:\MyTests.
2. Start MATLAB and set the current directory in MATLAB to the folder you just created. For example:

```
cd C:\MyTests
```

3. Enter the following MATLAB command:

```
copyFILDemoFiles('pid')
```

This command creates the sub folder `.\pid_hdlsrc` in your current folder and copies all the source files under `matlabroot\toolbox\shared\eda\fil\fil demos\fil_pid` into it. `matlabroot` is the MATLAB root folder on your system. You will now have the following files in `C:\MyTests\pid_hdlsrc`:

- D_component.vhd
- I_component.vhd
- Controller.vhd

4. Set Up FPGA design software

Before using FPGA-in-the-Loop, set up your system environment for accessing FPGA design software. You can use the function `hdlsetuptoolpath` to add ISE or Quartus II to the system path for the current MATLAB session.

For Xilinx FPGA boards with Spartan-6 or Virtex-6 FPGAs, run:

```
hdlsetuptoolpath('ToolName', 'Xilinx ISE', 'ToolPath', 'C:\Xilinx\13.1\ISE_DS\ISE\bin\nt64\ise.exe')
```

This example assumes that the Xilinx ISE executable is `C:\Xilinx\13.1\ISE_DS\ISE\bin\nt64\ise.exe`. Substitute with your actual executable if it is different.

For Xilinx FPGA boards with 7-series FPGAs, run:

```
hdlsetuptoolpath('ToolName', 'Xilinx Vivado', 'ToolPath', 'C:\Xilinx\Vivado\2013.4\bin\vivado.bat')
```

This example assumes that the Xilinx Vivado executable is `C:\Xilinx\Vivado\2013.4\bin\vivado.bat`. Substitute with your actual executable if it is different.

For Altera boards, run:

```
hdlsetuptoolpath('ToolName', 'Altera Quartus II', 'ToolPath', 'C:\altera\11.0\quartus\bin\quartus.exe')
```

This example assumes that the Altera Quartus II executable is `C:\altera\11.0\quartus\bin\quartus.exe`. Substitute with your actual executable if it is different.

5. Open the fil_pid.mdl model.

This model contains a fixed-point PID controller implemented with basic Simulink blocks. This model also contains a DC motor model controlled by this PID controller as well as the desired DC motor position as the input stimulus.

Run this model now and observe the desired and actual motor positions in the scope.

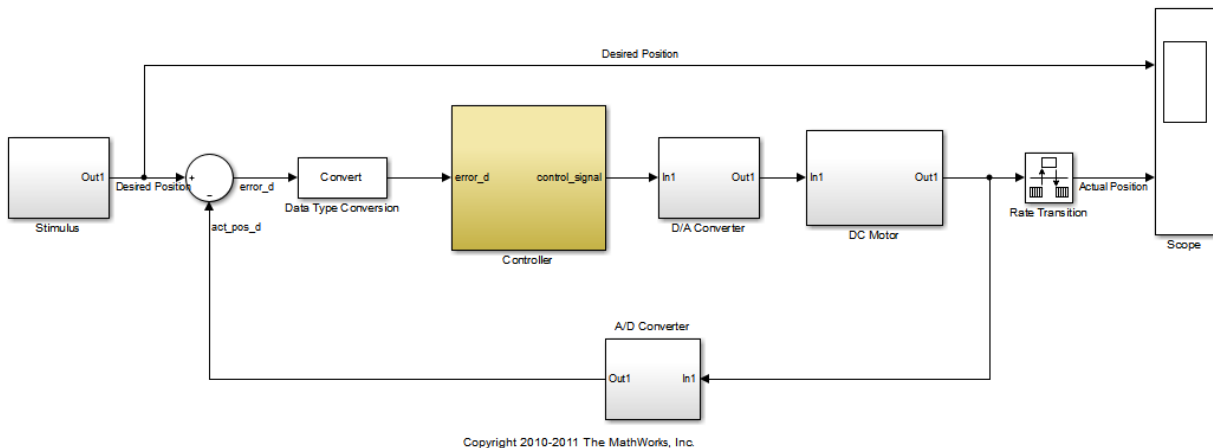

Step 4: Launch FPGA-in-the-Loop (FIL) Wizard

Launch the FPGA-in-the-Loop Wizard by doing the following:

From the Code menu in the fil_pid model window, select **Verification Wizards -> FPGA-in-the-Loop (FIL)...**

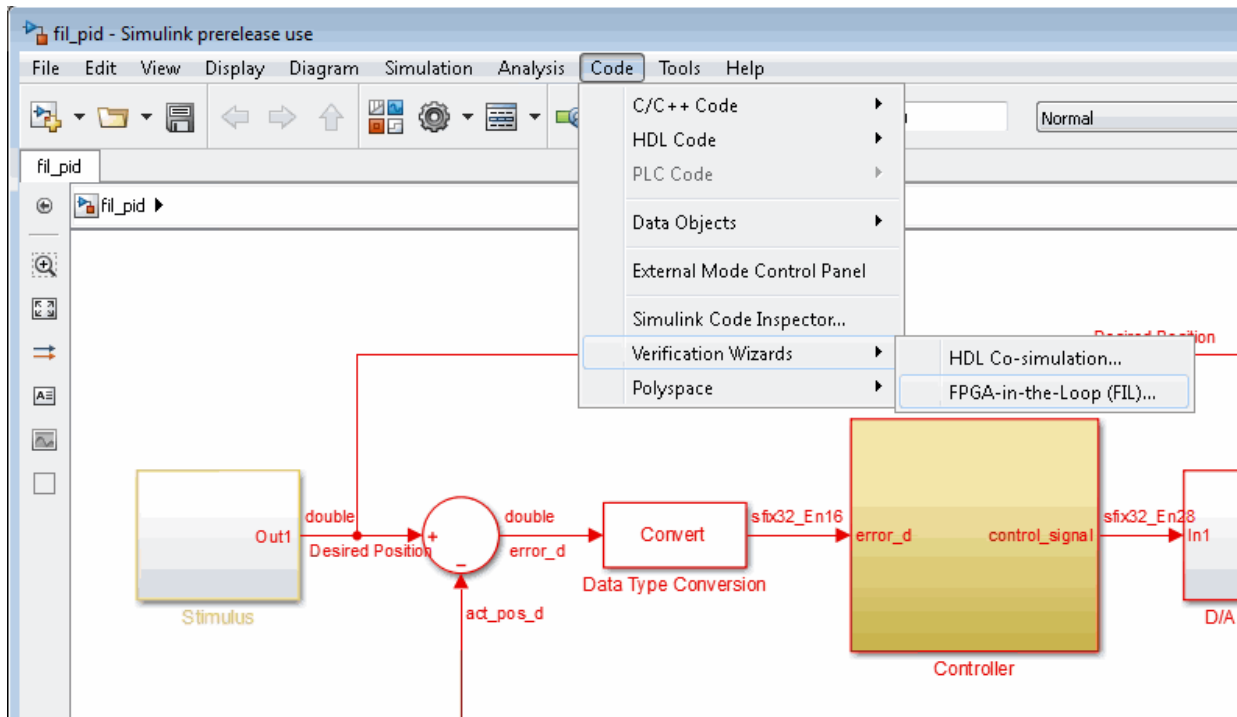

Alternatively, you can enter the `filWizard` command at the MATLAB command prompt.

```
filWizard
```

Step 5: Specify Hardware Options in FIL Wizard

Set the FIL options for the FPGA development board.

1. Specify if the wizard will generate a FIL Simulink block or a FILSimulation MATLAB System Object. For this example, select **Simulink** for **FIL simulation with Simulink**.

2. For **Board Name**, select the FPGA development board connected to your host computer. If your board is not on the list, select one of the following options:

- "Get more boards..." to download the FPGA board support package(s) (this option starts the Support Package Installer).
- "Create custom board..." to create the FPGA board definition file for your particular FPGA board (this option starts the New FPGA Board Manager).

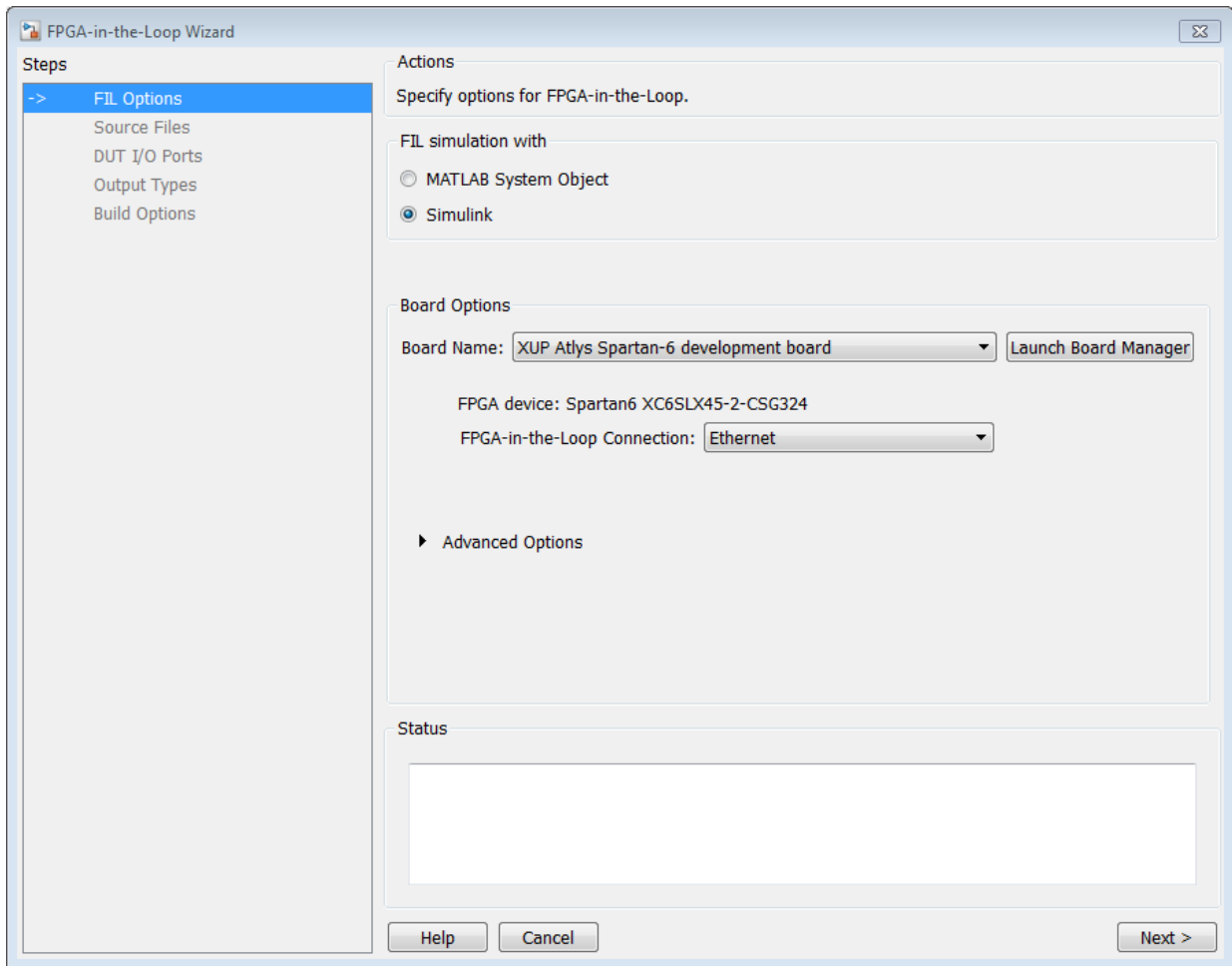

3. Select the connection for simulation. The available connection methods are Ethernet and JTAG. Not all boards support both connection methods.

4. Ethernet connection only: If you changed your computer's IP address to a different subnet from 192.168.0.x when you set up the network adapter, or if the default board IP address 192.168.0.2 is in use by another device, expand **Advanced Options** and change the **Board IP address** according to the following guidelines:

- The subnet address, typically the first three bytes of board IP address, must be the same as those of the host IP address.
- The last byte of the board IP address must be different from that of the host IP address.
- The board IP address must not conflict with the IP addresses of other computers.

For example, if the host IP address is 192.168.8.2, then you can use 192.168.8.3 if it is available. Do not change **Board MAC address**.

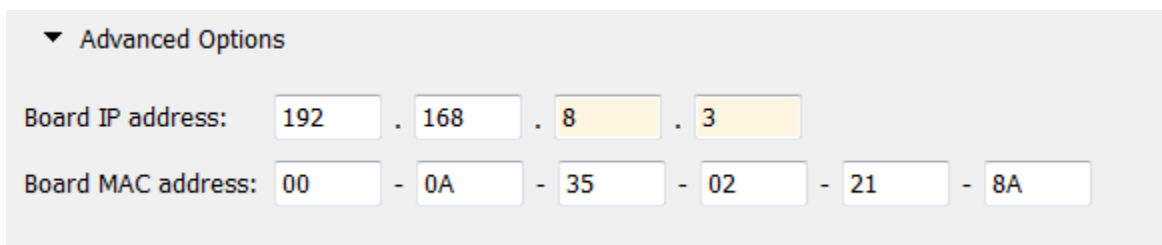

▼ Advanced Options

Board IP address: 192 . 168 . 8 . 3

Board MAC address: 00 - 0A - 35 - 02 - 21 - 8A

5. Click **Next** to continue.

Step 6: Specify HDL Files in the FIL Wizard

Specify the HDL design to be implemented in the FPGA.

1. Click Add and browse to the directory you created in Prepare Example Resources.
2. Select these HDL files:
 - Controller.vhd
 - D_component.vhd
 - I_component.vhd

These are the HDL design files to be verified on the FPGA board. 3. In the **Source Files** table, check the checkbox on the row of file **Controller.vhd** to specify that this HDL file contains the top-level HDL module.

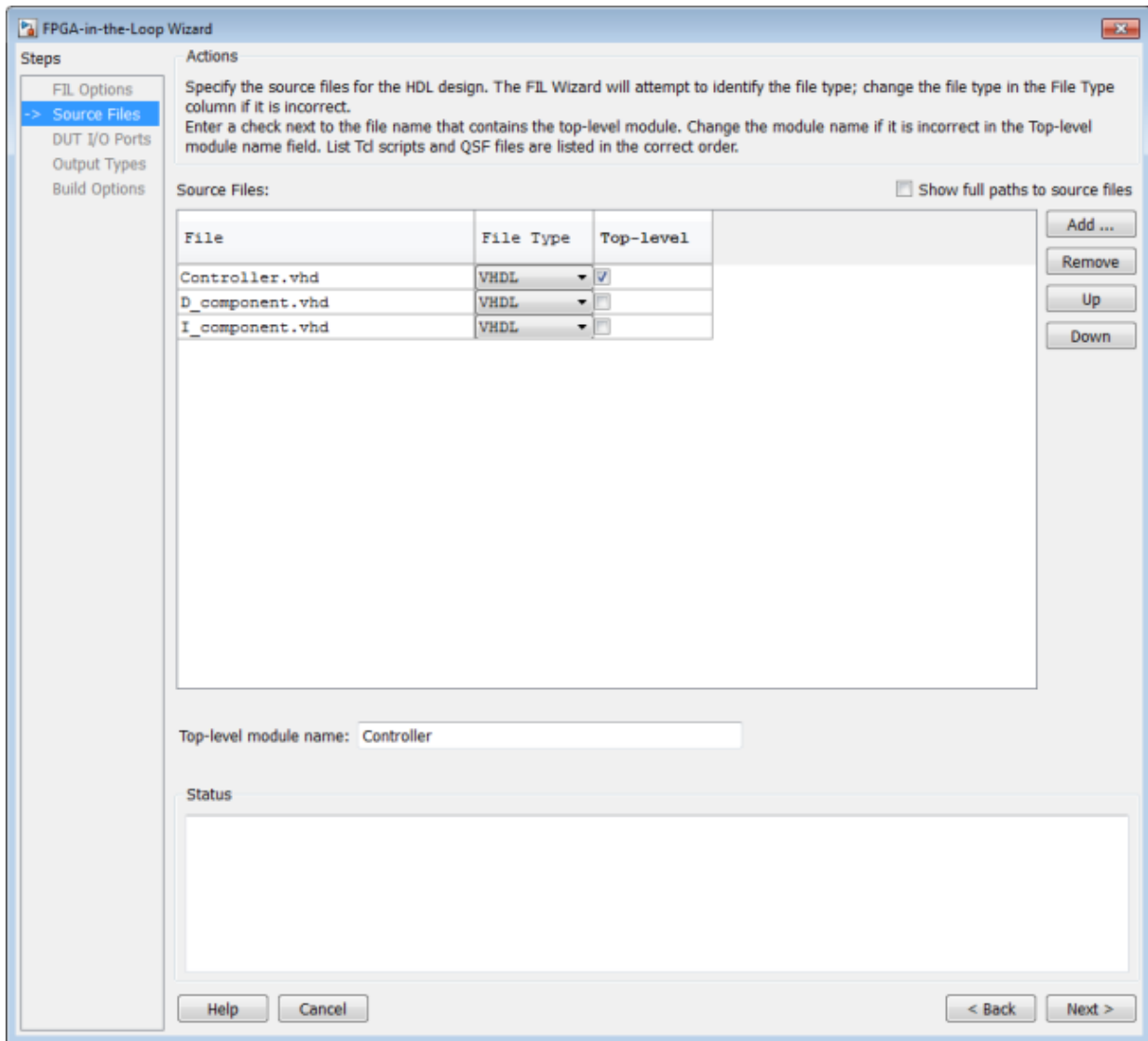

The FIL Wizard automatically fills the **Top-level module name** field with the name of the selected HDL file; in this case, **Controller**. In this example, the top-level module name matches the file name so that you do not need to change it. If the top-level module

name and file name did not match, you would manually correct the top-level module name in this dialog.

Click **Next** to continue.

Step 7: Review I/O Ports in FIL Wizard

The FIL Wizard parses the top-level HDL module `Controller` in `Controller.vhd` to obtain all the I/O ports and display them in the **DUT I/O Ports** table. The parser attempts to automatically determine the possible port types by looking at the port names and displays these signals under **Port Type**.

1. Review the port listing. If the parser assigned an incorrect port type for any given port, you can manually change the signal. For synchronous design, specify a **Clock**, **Reset**, or **Clock enable** signal. In this example, the FIL Wizard automatically fills the table correctly.

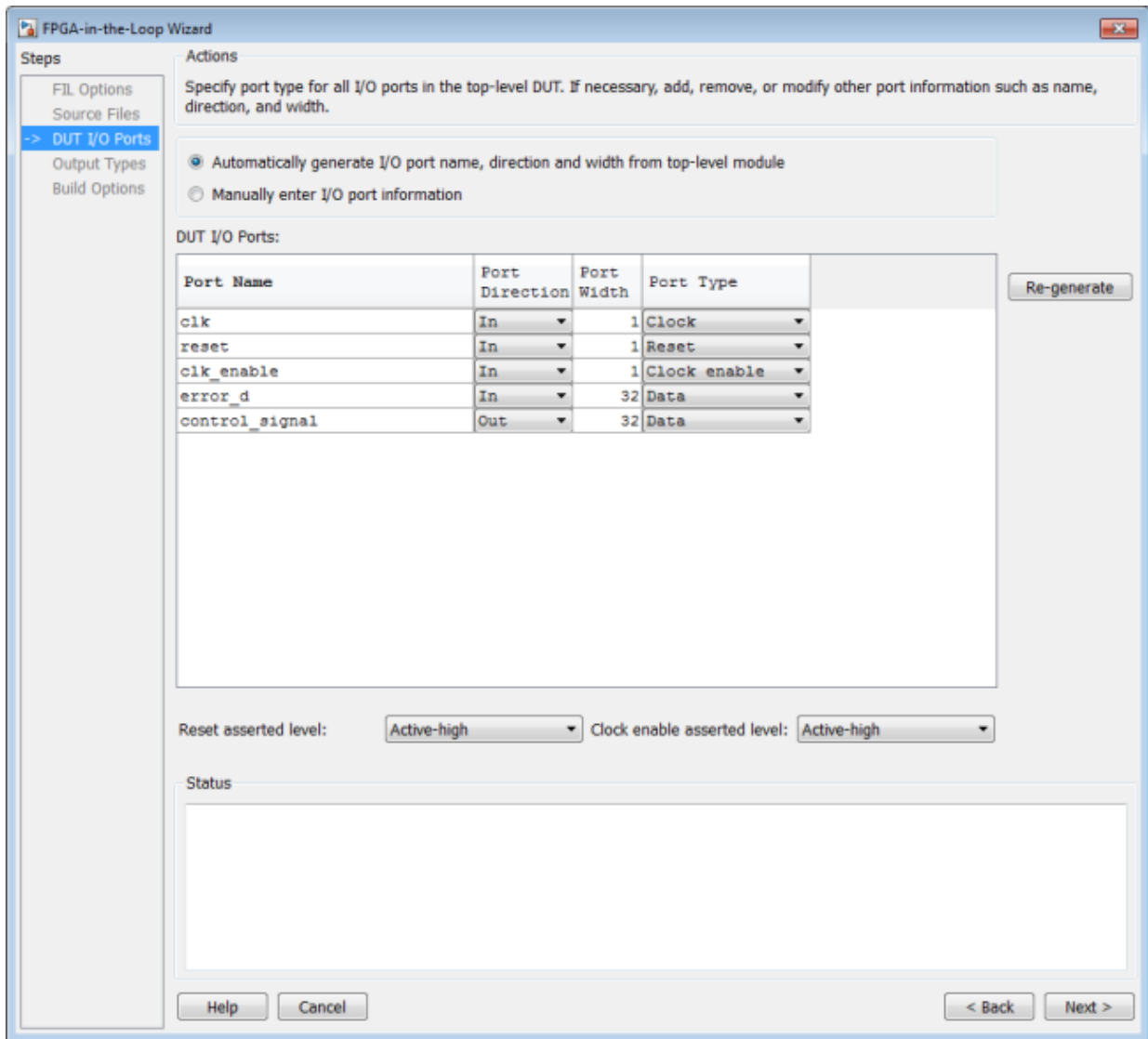

2. Click **Next** to continue.

Step 8: Set Output Data Types in FIL Wizard

1. For the HDL output `control_signal` change **Data Type** to **Fixedpoint**, **Sign** to **Signed** and **Fraction Length** to **28**. This will make the generated FIL block set the output signal of the FPGA design-under-test (DUT) to the correct data type.

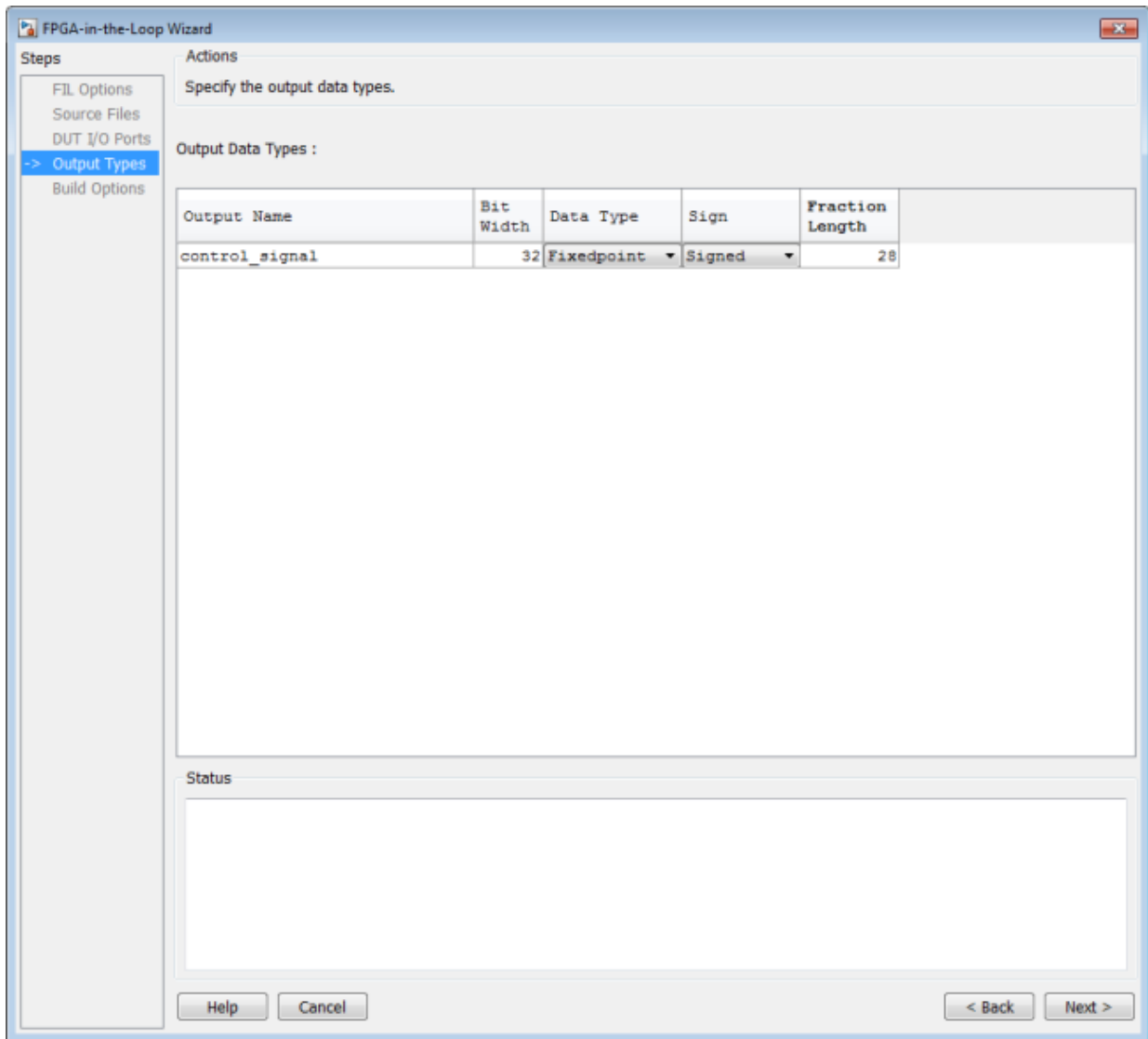

2. Click **Next** to continue.

Step 9: Review Build Options in FIL Wizard

1. Specify the folder for the output files. For this example, use the default option, which is a subfolder named **Controller_fil** under the current directory.

The **Summary** displays the locations of the FPGA project file and the FPGA programming file. You may need those two files for advanced operations.

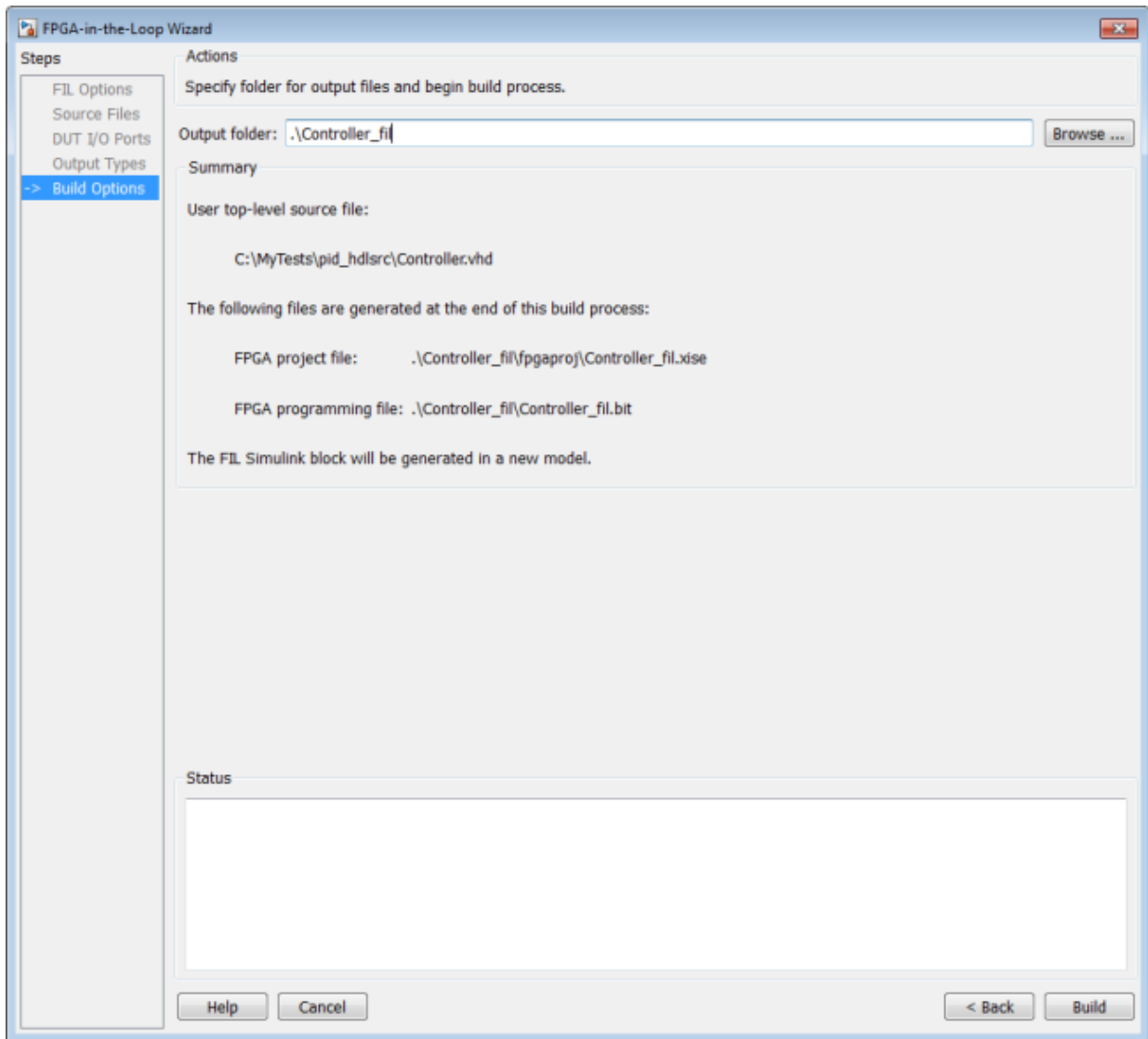

2. Click **Build** to start the build process.

During the build process, the following actions occur:

- A FIL block named Controller is generated in a new model as shown in the following figure. Do not close this model.

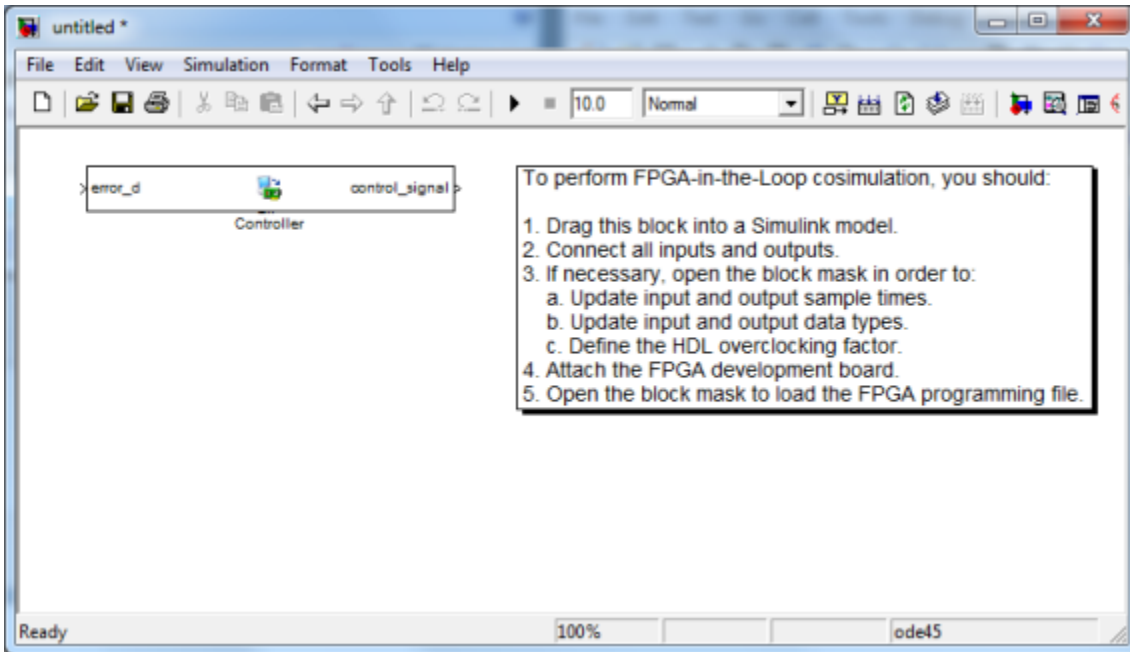

- After new model generation, the FIL Wizard opens a command window where the FPGA design software performs synthesis, fit, place-and-route, timing analysis, and FPGA programming file generation.
- When the FPGA design software process is finished, a message in the command-line window lets you know you can close the window. Close the window and proceed to the next step.

```
Process "Generate Programming File" completed successfully
INFO:TclTasksC:1850 - process run : Generate Programming File is done.

Programming file generated:
C:\MyTests\Controller_fil\Controller_fil.bit

FPGA-in-the-Loop build completed.
You may close this shell.

C:\MyTests\Controller_fil\fpgaproj>
```

Step 10: Set Up Model

In the `fil_pid` model, replace the **Controller** subsystem with the FIL block generated in the new model. The modified `fil_pid` model now appears as shown in the following illustration:

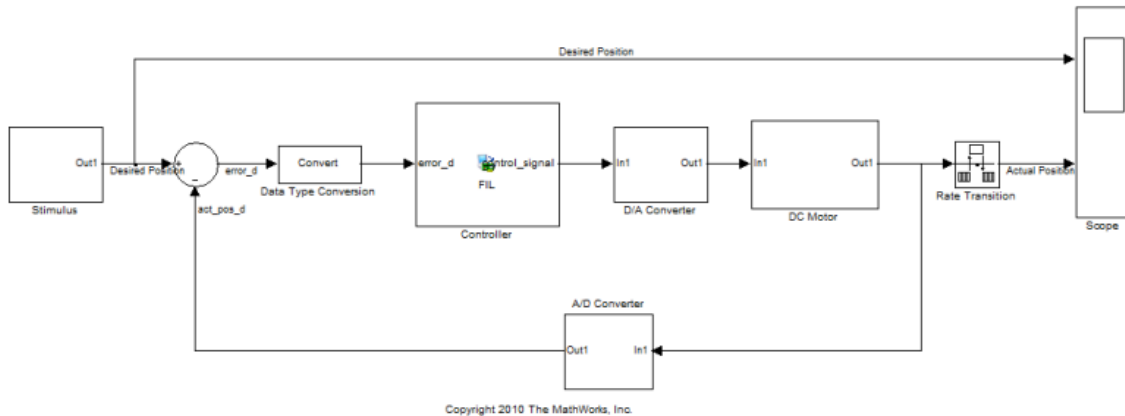

Step 11: Program FPGA

1. Switch FPGA development board power **ON**.
2. Double-click the FIL block in the `fil_pid` model to open the block mask.
3. In the opened block mask, click **Load**.

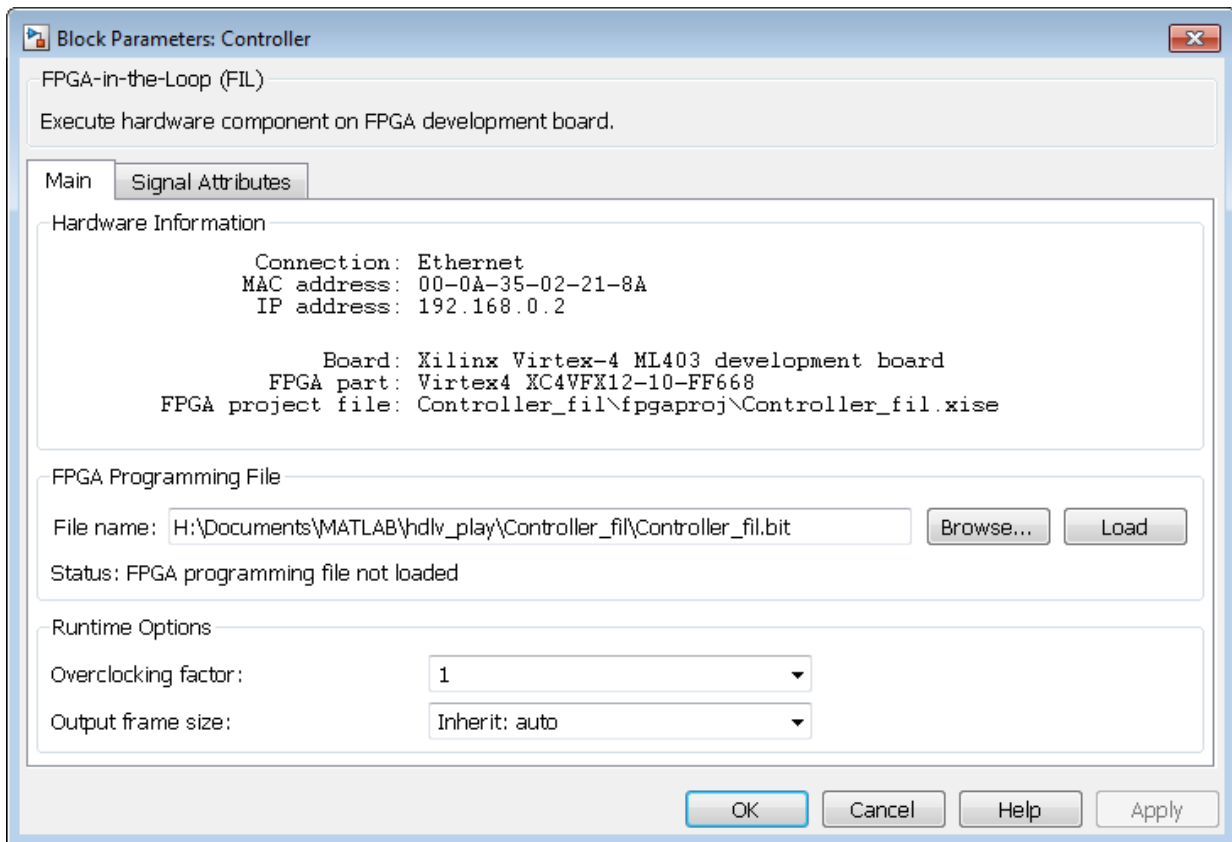

If your board is connected to the host computer through the JTAG cable properly, a message window displays to indicate that the FPGA programming file is loaded successfully. Click **OK** to dismiss this dialog.

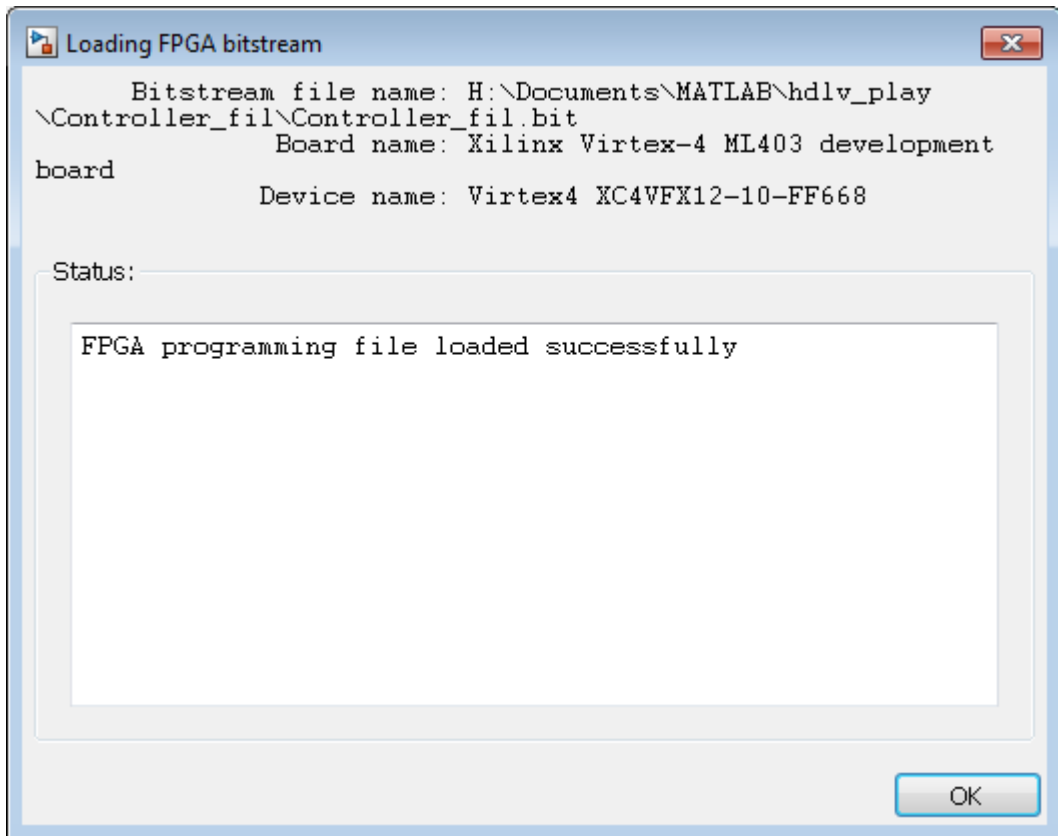

4. Ethernet connection only: You can test if the FPGA board is connected to your host computer properly through the ping test. Launch a command-line window and enter the following command:

```
C:\MyTests> ping 192.168.0.2
```

If you changed the board IP address when you set up the network adapter, replace 192.168.0.2 with your board IP address. If the Gigabit Ethernet connection has been set up properly, you should see the ping reply from the FPGA development board.

Step 12: Review Parameters of FIL Block

1. In the FIL block mask, click the **Signal Attributes** tab.

2. Verify that the **Data Type** of the HDL signal **control_signal** is **fixdt(1,32,28)**. If it is not, change it.
3. Click **OK** to close the block mask.

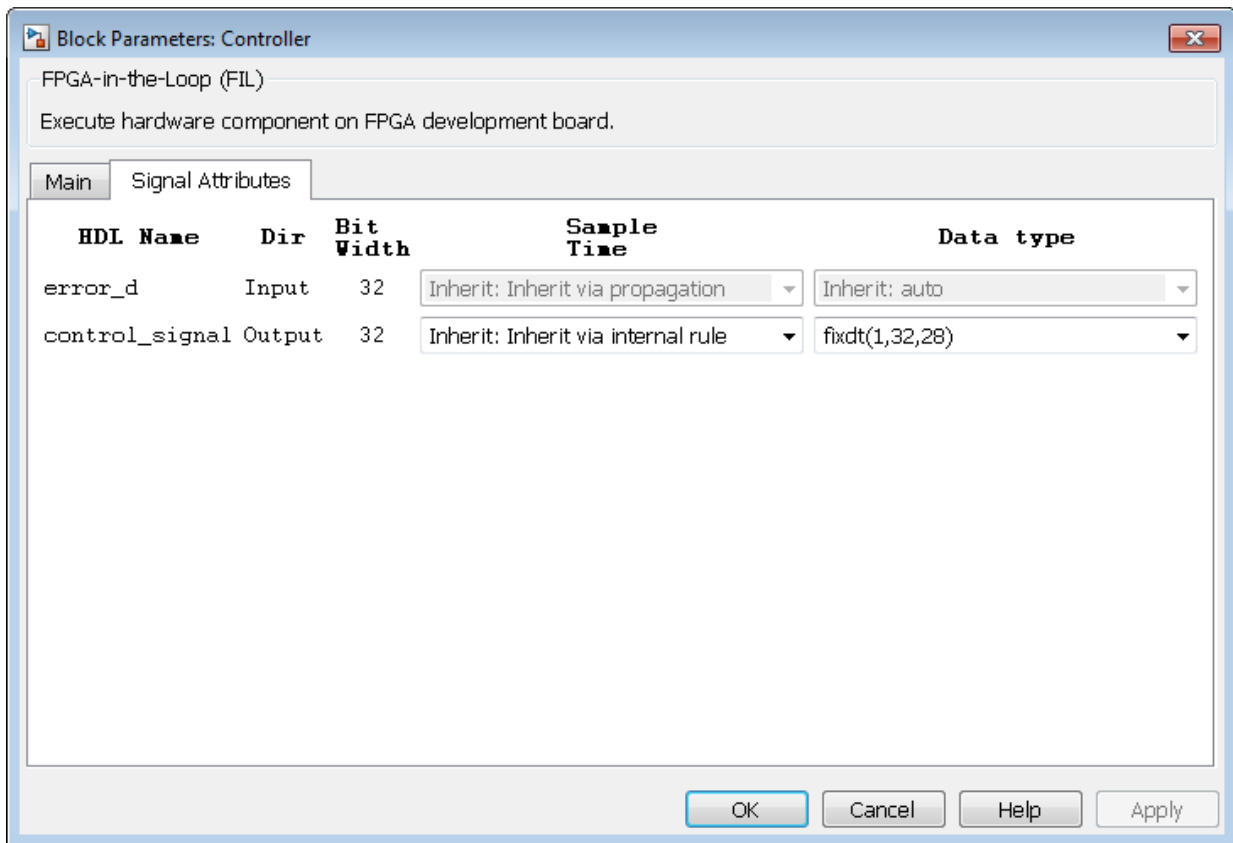

Step 13: Run FIL

1. Start simulation of the `fil_pid` model.
2. When the simulation is done, view the waveform of the desired and actual positions of the motor in the scope. Note that the results of FIL simulation should match those of the Simulink reference model that you simulated in **Prepare Example Resources**.

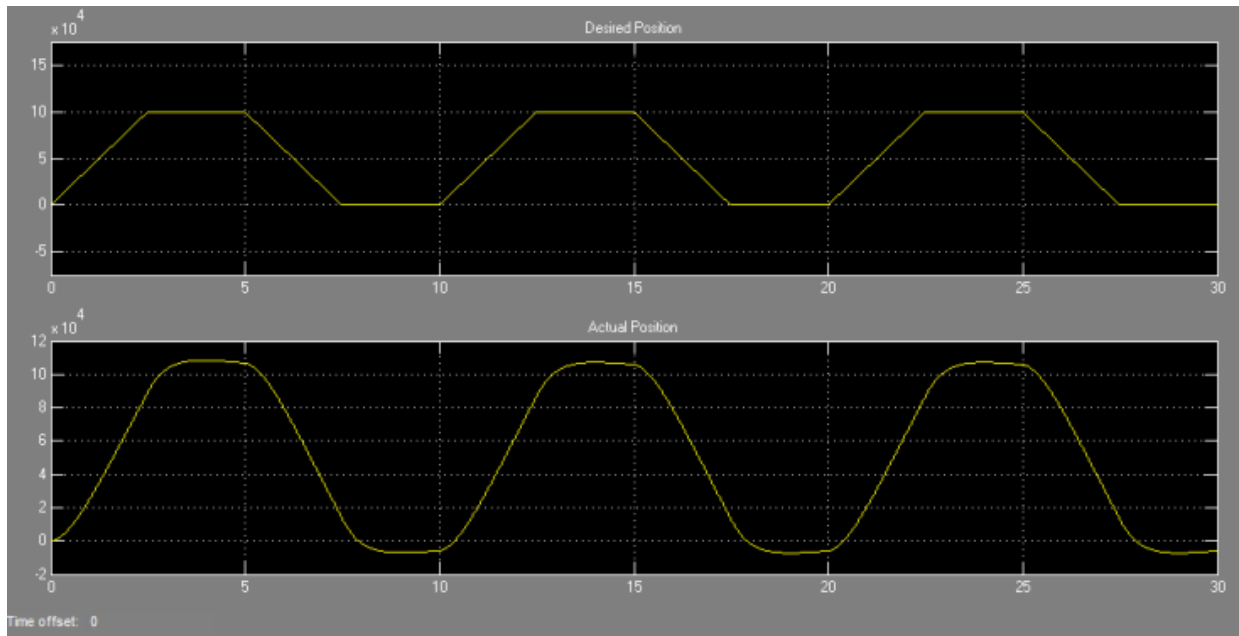

Verify Digital Up-Converter Using FPGA-in-the-Loop

This example shows you how to verify a digital up-converter design generated with Filter Design HDL Coder™ using FPGA-in-the-Loop simulation.

Requirements

Products required for this example:

- MATLAB
- Simulink
- HDL Verifier
- Fixed-Point Designer
- Signal Processing Toolbox
- DSP System Toolbox
- Filter Design HDL Coder (optional)
- FPGA design software (Xilinx® ISE® or Vivado® design suite or Altera® Quartus® II design software)
- One of the supported FPGA development boards and accessories (the ML403 board is not supported for this example)
- For connection using Ethernet: Gigabit Ethernet Adapter installed on host computer, Gigabit Ethernet crossover cable
- For connection using JTAG: JTAG cable with USB Blaster I or II, USB Blaster driver
- For connection using PCI Express®: FPGA board installed into PCI Express slot of host computer.

Create Cascade Filter for DUC

A digital up-converter (DUC) is a digital circuit that converts a digital baseband signal to a passband signal. A DUC is composed of three filtering stages; each stage filters the input signal with a lowpass interpolating filter, followed by a sample rate change. In this example, the DUC is a cascade of two FIR interpolation filters and a CIC interpolation filter, as described in the example HDL Digital Up-Converter (DUC).

1. Create the two FIR and CIC filters.

```
pfir = [0.0007    0.0021   -0.0002   -0.0025   -0.0027    0.0013    0.0049    0.0032    .
```



```

-0.0034 -0.0074 -0.0031 0.0060 0.0099 0.0029 -0.0089 -0.0129 .
-0.0032 0.0124 0.0177 0.0040 -0.0182 -0.0255 -0.0047 0.0287 .
0.0390 0.0049 -0.0509 -0.0699 -0.0046 0.1349 0.2776 0.3378 .
0.2776 0.1349 -0.0046 -0.0699 -0.0509 0.0049 0.0390 0.0287 .
-0.0047 -0.0255 -0.0182 0.0040 0.0177 0.0124 -0.0032 -0.0129 .
-0.0089 0.0029 0.0099 0.0060 -0.0031 -0.0074 -0.0034 0.0032 .
0.0049 0.0013 -0.0027 -0.0025 -0.0002 0.0021 0.0007 ];

```

```

hpfir = dsp.FIRInterpolator(2, pfir);
hpfir.FullPrecisionOverride = false;
hpfir.CoefficientsDataType = 'Custom';
hpfir.CustomCoefficientsDataType = numerictype([],16);
hpfir.ProductDataType = 'Custom';
hpfir.CustomProductDataType = numerictype([],31,31);
hpfir.AccumulatorDataType = 'Custom';
hpfir.CustomAccumulatorDataType = numerictype([],16,15);
hpfir.OutputDataType = 'Custom';
hpfir.CustomOutputDataType = numerictype([],16,15);
hpfir.RoundingMethod = 'Nearest';

```

```

cfir = [-0.0007 -0.0009 0.0039 0.0120 0.0063 -0.0267 -0.0592 -0.0237
0.1147 0.2895 0.3701 0.2895 0.1147 -0.0237 -0.0592 -0.0267
0.0063 0.0120 0.0039 -0.0009 -0.0007];

```

```

hcfir = dsp.FIRInterpolator(2, cfir);
hcfir.FullPrecisionOverride = false;
hcfir.CoefficientsDataType = 'Custom';
hcfir.CustomCoefficientsDataType = numerictype([],16);
hcfir.ProductDataType = 'Custom';
hcfir.CustomProductDataType = numerictype([],31,31);
hcfir.AccumulatorDataType = 'Custom';
hcfir.CustomAccumulatorDataType = numerictype([],16,15);
hcfir.OutputDataType = 'Custom';
hcfir.CustomOutputDataType = numerictype([],16,15);
hcfir.RoundingMethod = 'Nearest';

```

```

hcic = dsp.CICInterpolator(32, 1, 5);
hcic.FixedPointDataType = 'Minimum section word lengths';
hcic.OutputWordLength = 20;

```

2. Create a cascade filter using these filters.

```

hduc = dsp.FilterCascade(hpfir, hcfir, hcic);

```

The frequency response of the cascade filter is shown in the following figure.

```
fvtool(hduc, 'Arithmetic', 'fixed');
```

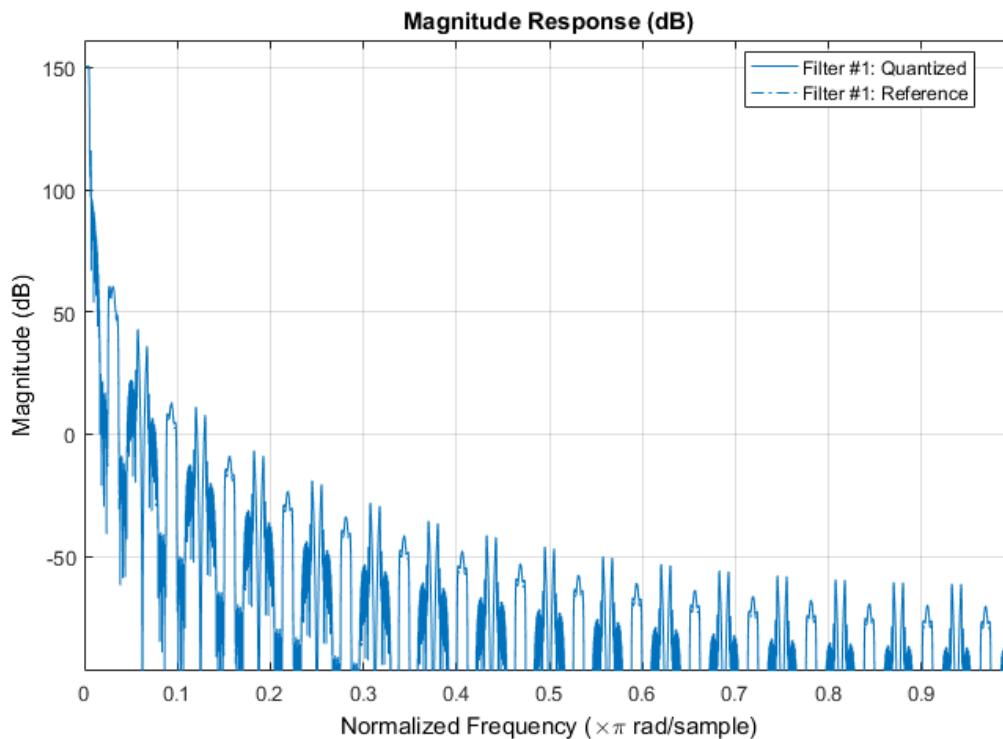

Generate HDL Code

When the cascade filter is ready, generate HDL code for the DUC using the Filter Design HDL Coder function `generatehdl`, with the property `'AddPipelineRegisters'` set to `'on'`.

```
>> generatehdl(hduc, 'Name', 'hdlduc', 'AddPipelineRegisters', 'on', 'InputDataType', 'float');
```

This option inserts pipeline registers between filter stages, and allows the generated filter to be synthesized at a higher clock frequency.

If you do not have Filter Design HDL Coder, you can copy pre-generated HDL files to the current directory using this command:

```
>> copyFILDemoFiles('duc');
```

Set Up FPGA Design Software

Before using FPGA-in-the-Loop, make sure your system environment is set up properly for accessing FPGA design software. You can use the function **hdlsetuptoolpath** to add ISE or Quartus II to the system path for the current MATLAB session.

For Xilinx FPGA boards, run

```
hdlsetuptoolpath('ToolName', 'Xilinx ISE', 'ToolPath', 'C:\Xilinx\13.1\ISE_DS\ISE\bin\
```

This example assumes that the Xilinx ISE executable is C:\Xilinx\13.1\ISE_DS\ISE\bin\nt64\ise.exe. Substitute with your actual executable if it is different.

For Altera boards, run

```
hdlsetuptoolpath('ToolName', 'Altera Quartus II', 'ToolPath', 'C:\altera\11.0\quartus\bin\
```

This example assumes that the Altera Quartus II executable is C:\altera\11.0\quartus\bin\quartus.exe. Substitute with your actual executable if it is different.

Configure and Build FPGA-in-the-Loop

The FIL Wizard guides you in configuring settings necessary for building FPGA-in-the-Loop. Launch the wizard with the following command:

```
>> filWizard
```

1. In Hardware Options, select the FPGA development board connected to your host computer. If necessary, you can also customize the Board IP and MAC Address under Advanced Options. Click *Next" to continue.
2. In Source Files, add the following generated HDL files for the DUC to the source file table using **Browse**.

```
hdlduc.vhd
hdlduc_stage1.vhd
hdlduc_stage2.vhd
hdlduc_stage3.vhd
```

Select the top-level checkbox next to `hdlduc.vhd`. Click *Next" to continue.

3. In DUT I/O Ports, the input and output port information, such as port name, direction, width and port type are automatically generated from the HDL file. Port types, such as Clock and Data, are generated based on port names; you may change the selection as necessary. For this example, the generated port types are correct, and you can click **Next**.

4. In Build Options, specify the folder for FIL output files. You can use the default value for this example. Click **Build**. Clicking **Build** causes the FIL Wizard to generate all the necessary files for FPGA-in-the-Loop simulation and perform the following actions:

- Generates a FIL block in a new Simulink® model
- Opens a command-line window to compile the FPGA project and generate the FPGA programming file

The FPGA project compilation process takes several minutes. When the process is finished, you are prompted to close the command-line window. Close this window now.

Configure FIL Block

To prepare for FPGA-in-the-Loop simulation, follow the steps below to configure the FIL block.

1. Open the test bench model `fil_duc_model` and copy the generated FIL block into the model.

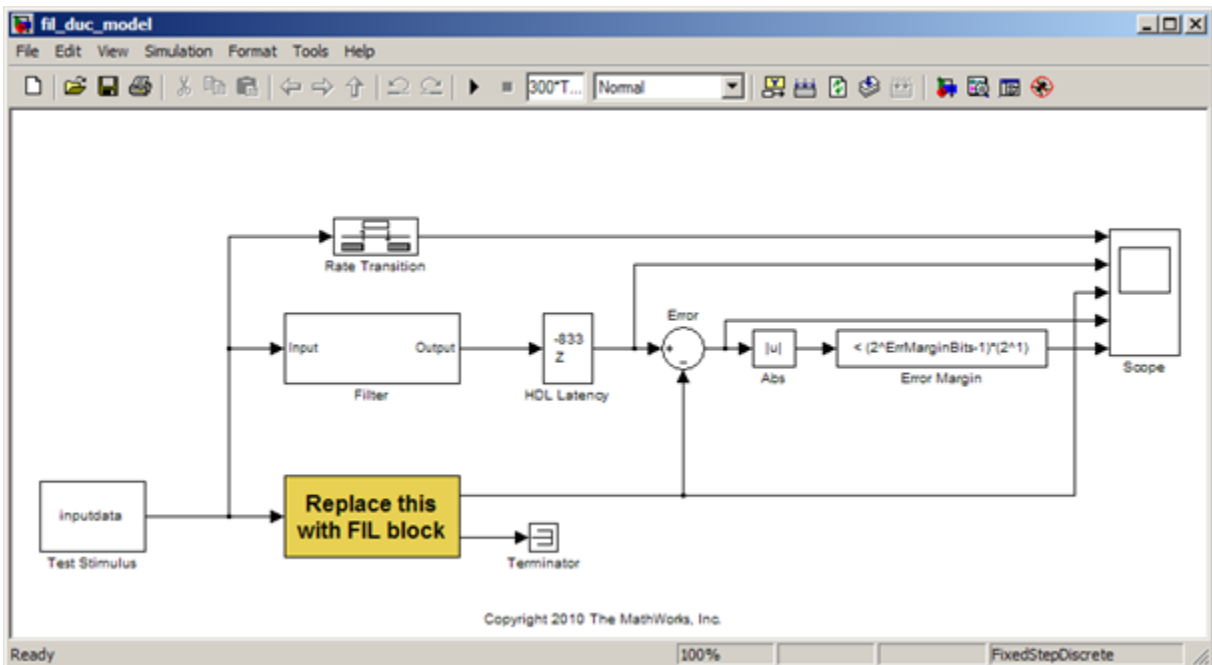

2. Double-click the FIL block to open the block mask. Click **Load** to program the FPGA with the generated programming file.
3. Under Runtime Options, change **Overclocking factor** to 128. This specifies that an input value is sampled 128 times by the FPGA clock before the input changes value.
4. On the FIL block mask, click on the Signal Attributes tab. Change the data type for filter_out to `fixdt(1,20,-1)` to match the data type of the behavioral filter block.
5. Click **OK** to close the block mask.

Verify Generated Filter

In this example, the generated filter running on FPGA is compared to a behavioral filter block. Delays are added to the output of the behavioral filter to match the HDL latency of the generated filter.

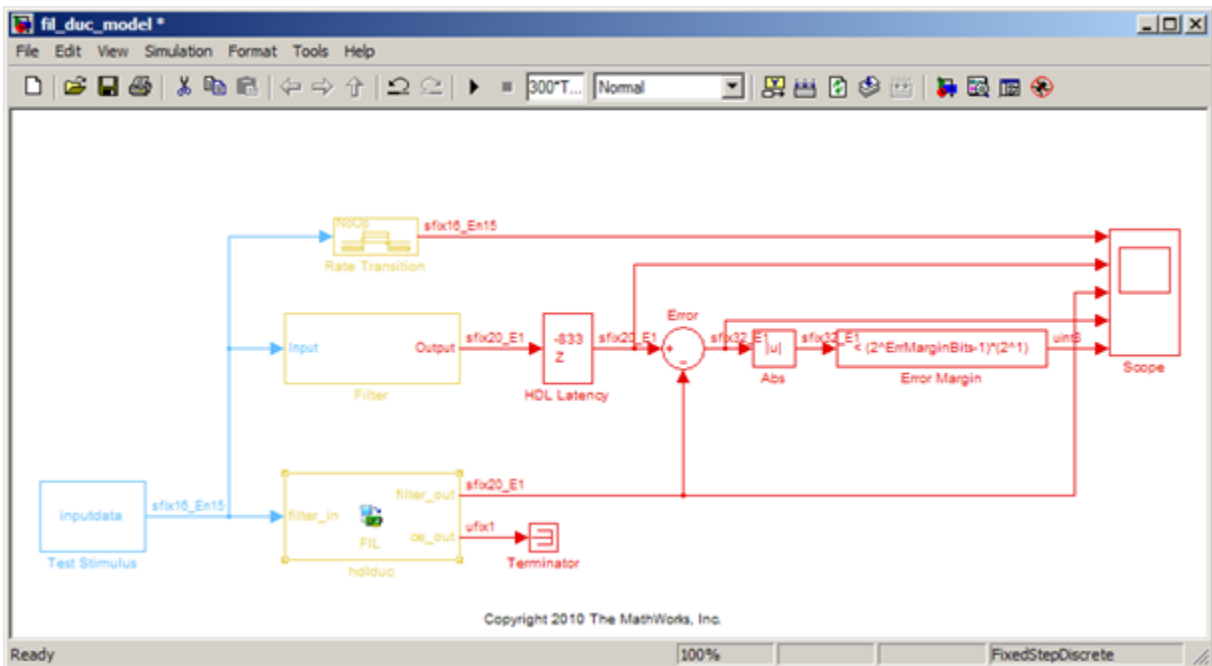

Run simulation. Observe the output waveforms from the behavioral filter block, the FIL block, and the error margin. Because the behavioral filter block does not have pipeline

registers, there are small differences between the behavioral filter block output and the FIL block output. These errors are within the error margin.

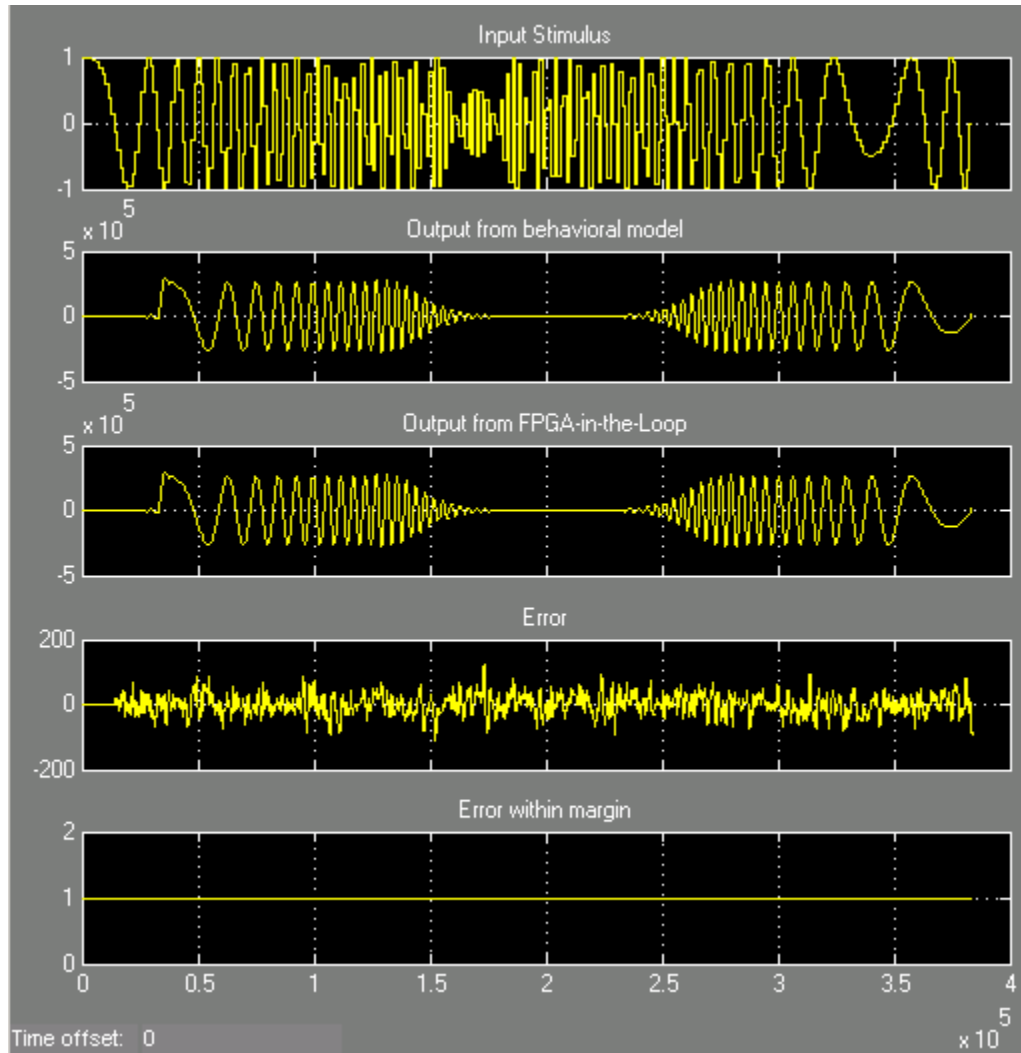

This concludes the example.

FPGA Board Customization

- “FPGA Board Customization” on page 15-2
- “Create Custom FPGA Board Definition” on page 15-7
- “Create Xilinx KC705 Evaluation Board Definition File” on page 15-8
- “FPGA Board Manager” on page 15-21
- “New FPGA Board Wizard” on page 15-25
- “FPGA Board Editor” on page 15-38

FPGA Board Customization

In this section...

“Feature Description” on page 15-2

“Custom Board Management” on page 15-2

“FPGA Board Requirements” on page 15-3

Feature Description

Both HDL Coder and HDL Verifier software include a set of predefined FPGA boards you can use with the Turnkey or FPGA-in-the-loop (FIL) workflows. You can view the lists of these supported boards in the HDL Workflow Advisor or in the FIL wizard. With the FPGA Board Manager, you can add additional boards to use either of these workflows. To add a board, you need the relevant information from the board specification documentation.

The FPGA Board Manager is the hub for accessing wizards and dialog boxes that take you through the steps necessary to create a custom board configuration. You can also access options for:

- Importing a custom board
- Copying a board definition file for further modification
- Verifying a new board

Custom Board Management

You manage FPGA custom boards through the following user interfaces:

- “FPGA Board Manager” on page 15-21: portal to adding, importing, deleting, and otherwise managing board definition files.
- “New FPGA Board Wizard” on page 15-25: This wizard guides you through creating a custom board definition file with information you obtain from the board specification documentation.
- “FPGA Board Editor” on page 15-38: user interface for viewing or editing board information.

To begin, review the “FPGA Board Requirements” on page 15-3 and then follow the steps described in “Create Custom FPGA Board Definition” on page 15-7.

FPGA Board Requirements

- “FPGA Device” on page 15-3
- “FPGA Design Software” on page 15-3
- “General Hardware Requirements” on page 15-3
- “Ethernet Connection Requirements for FPGA-in-the-Loop” on page 15-4
- “JTAG Connection Requirements for FPGA-in-the-Loop” on page 15-6

FPGA Device

Select one of the following links to view a current list of supported FPGA device families:

- For use with FPGA-in-the-loop (FIL), see “Supported FPGA Device Families for Board Customization” in the HDL Verifier documentation.
- For use with FPGA Turnkey, see “Supported FPGA Device Families for Board Customization” in the HDL Coder documentation.

FPGA Design Software

Altera Quartus II or Xilinx ISE is required. See product documentation for HDL Coder or HDL Verifier for the specific software versions required.

The following MathWorks tools are required to use FIL or FPGA Turnkey.

Workflow	Required Tools
FPGA-in-the-loop	<ul style="list-style-type: none"> • HDL Verifier • Fixed-Point Designer™
FPGA Turnkey	<ul style="list-style-type: none"> • HDL Coder • Simulink • Fixed-Point Designer

General Hardware Requirements

To use an FPGA development board, make sure that you have the following FPGA resources:

- **Clock:** An external clock connected to the FPGA is required. The clock can be differential or single-ended. The accepted clock frequency is from 5 MHz to 300 MHz. When used with FIL, there are additional requirements to the clock frequency (see “Ethernet Connection Requirements for FPGA-in-the-Loop” on page 15-4).

- **Reset:** An external reset signal connected to the FPGA is optional. When supplied, this signal functions as the global reset to the FPGA design.
- **JTAG download cable:** A JTAG download cable that connects host PC and FPGA board is required for the FPGA programming. The FPGA must be programmable using Xilinx iMPACT or Altera Quartus II.

Ethernet Connection Requirements for FPGA-in-the-Loop

- “Supported Ethernet PHY Device” on page 15-4
- “Ethernet PHY Interface” on page 15-4
- “Special Timing Considerations for RGMII” on page 15-5
- “Special Clock Frequency Requirement for GMII/RGMII/SGMII Interface” on page 15-5

Supported Ethernet PHY Device

On the FPGA board, the Ethernet MAC is implemented in FPGA. An Ethernet PHY chip is required to be on the FPGA board to connect the physical medium to the Media Access (MAC) layer in the FPGA.

Note: When programming the FPGA, HDL Verifier assumes that there is only one download cable connected to the Host PC. It also assumes that the FPGA programming software automatically recognizes the cable. If not, use FPGA programming software to program your FPGA with the correct options.

The FIL feature is tested with the following Ethernet PHY chips and may not work with other Ethernet PHY devices.

Ethernet PHY Chip	Test
Marvell® Alaska 88E1111	For GMII, RGMII, SGMII, and 100 Base-T MII interfaces
National Semiconductor DP83848C	For 100 Base-T MII interface only

Ethernet PHY Interface

The Ethernet PHY chip must be connected to the FPGA using one of the following interfaces:

Interface	Note
Gigabit Media Independent Interface (GMII)	Only 1000 Mbits/s speed is supported using this interface.
Reduced Gigabit Media Independent Interface (RGMII)	Only 1000 Mbits/s speed is supported using this interface.
Serial Gigabit Media Independent Interface (SGMII)	Only 1000 Mbits/s speed is supported using this interface.
Media Independent Interface (MII)	Only 100 Mbits/s speed is supported using this interface.

Note: For GMII, the TXCLK (clock signal for 10/100 Mbits signal) signal is not required because only 1000 Mbits/s speed is supported.

In addition to the standard GMII/RGMII/SGMII/MII interface signals, FPGA-in-the-loop also requires an Ethernet PHY chip reset signal (ETH_RESET_n). This active-low reset signal performs the PHY hardware reset by FPGA. It is active-low.

Special Timing Considerations for RGMII

When the RGMII interface is used, the MAC on the FPGA assumes that the data are aligned with the edges of reference clock as specified in the original RGMII v1.3 standard. In this case, PC board designs provide additional trace delay for clock signals (RGMII v1.3).

The RGMII v2.0 standard allows the transmitter to integrate this delay so that PC board delay is not required. Marvell Alaska 88E1111 has internal registers to add internal delays to RX and TX clocks. The internal delays are not added by default, which means that you must use the MDIO module to configure Marvell 88E1111 to add internal delays. (See “FIL I/O” on page 15-31 for the usage of the MDIO module.)

Special Clock Frequency Requirement for GMII/RGMII/SGMII Interface

When GMII/RGMII/SGMII interfaces are used, the FPGA requires an exact 125 MHz clock to drive the 1000 Mbits/s communication. This clock is derived from the user supplied external clock using the clock module or PLL.

Not all external clock frequencies can derive an exact 125 MHz clock frequency. The acceptable clock frequencies vary depending on the FPGA device family. The recommended clock frequencies are 50, 100, 125, and 200 MHz.

JTAG Connection Requirements for FPGA-in-the-Loop

Vendor	Supported Devices	Required Hardware	Required Software
Altera	The FPGA board must be using an FPGA device in the supported Altera FPGA families.	<ul style="list-style-type: none"> • USB Blaster I or USB Blaster II download cable 	<ul style="list-style-type: none"> • USB Blaster I or II driver • For Windows operating systems: Quartus II executable directory must be on system path. • For Linux operating systems: versions below Quartus II 13.1 are not supported. Quartus II 14.1 is not supported. Only 64-bit Quartus II is supported. Quartus II library directory must be on LD_LIBRARY_PATH <i>before</i> starting MATLAB. Prepend the Linux distribution library path before the Quartus II library on LD_LIBRARY_PATH. For example, /lib/x86_64-linux-gnu: \$QUARTUS_PATH.
Xilinx	The board must be using one of the following supported Xilinx FPGAs: Artix [®] -7, Virtex-7, Kintex-7 or Zynq [®] 7000.	<ul style="list-style-type: none"> • Digilent download cable. If your board has a standard Xilinx 14 pin JTAG connector, you can obtain the HS2 cable from Digilent. 	<ul style="list-style-type: none"> • For Windows operating systems: Xilinx Vivado executable directory must be on system path. • For Linux operating systems: Digilent Adept2

Create Custom FPGA Board Definition

- 1 Be ready with the following:
 - a Board specification document. Any format you are comfortable with is fine. However, if you have it in an electronic version, you can search for the information as it is required.
 - b If you plan to validate (test) your board definition file, set up FPGA design software tools:

For validation, you must have Xilinx or Altera on your path. Use the `hdlsetuptoolpath` function to configure the tool for use with MATLAB.
- 2 Open the FPGA Board Manager by typing `fpgaBoardManager` in the MATLAB command window. Alternatively, if you are using the HDL Workflow Advisor, you can click **Launch Board Manager** at Step 1.1.
- 3 Open the New FPGA Board wizard by clicking **Create New Board**. For a description of all the tasks you can perform with the FPGA Board Manager, see “FPGA Board Manager” on page 15-21.
- 4 The wizard guides you through entering all board information. At each page, fill in the required fields. For assistance in entering board information, see “New FPGA Board Wizard” on page 15-25.
- 5 Save the board definition file. This step is the last and is automatically instigated when you click **Finish** in the New FPGA Board wizard. See “Save Board Definition File” on page 15-17.

Your custom board definition now appears in the list of available FPGA Boards in the FPGA Board Manager. If you are using HDL Workflow Advisor, it also shows in the **Target platform** list.

Follow the example “Create Xilinx KC705 Evaluation Board Definition File” on page 15-8 for a demonstration of adding a custom FPGA board with the New FPGA Board Manager.

Create Xilinx KC705 Evaluation Board Definition File

In this section...

“Overview” on page 15-8

“What You Need to Know Before Starting” on page 15-8

“Start New FPGA Board Wizard” on page 15-9

“Provide Basic Board Information” on page 15-10

“Specify FPGA Interface Information” on page 15-12

“Enter FPGA Pin Numbers” on page 15-13

“Run Optional Validation Tests” on page 15-15

“Save Board Definition File” on page 15-17

“Use New FPGA Board” on page 15-18

Overview

For FPGA-in-the-loop, you can use your own qualified FPGA board, even if it is not in the pre-registered FPGA board list supplied by MathWorks. Using the New FPGA Board wizard, you can create a board definition file that describes your custom FPGA board.

In this example, you can follow the workflow of creating a board definition file for the Xilinx KC705 evaluation board to use with FIL simulation.

What You Need to Know Before Starting

- Check the board specification so that you have the following information ready:
 - FPGA interface to the Ethernet PHY chip
 - Clock pins names and numbers
 - Reset pins names and numbers

In this example, the required information is supplied to you. In general, you can find this type of information in the board specification file. This example uses the KC705 Evaluation Board for the Kintex-7 FPGA User Guide, published by Xilinx.

- For validation, you must have Xilinx or Altera on your path. Use the `hdlsetuptoolpath` function to configure the tool for use with MATLAB.

- To verify programming the FPGA board after you add its definition file, attach the custom board to your computer. However, having the board connected is not necessary for creating the board definition file.

Start New FPGA Board Wizard

- 1 Start the FPGA Board Manager by entering the following command at the MATLAB prompt:

```
>>fpgaBoardManager
```
- 2 Click **Create Custom Board** to open the New FPGA Board wizard.

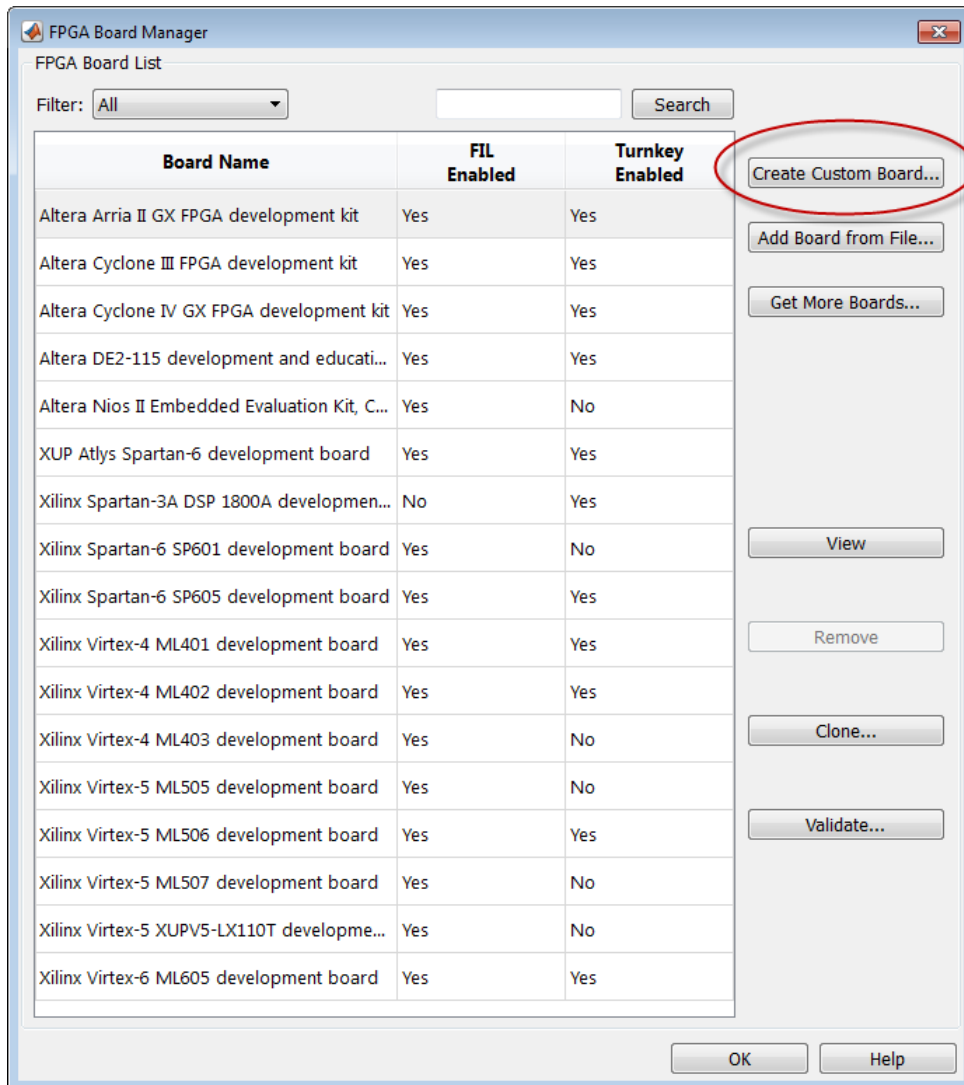

Provide Basic Board Information

- 1 In the Basic Information pane, enter the following information:

- **Board Name:** Enter "My Xilinx KC705 Board"
- **Vendor:** Select Xilinx
- **Family:** Select Kintex7
- **Device:** Select xc7k325t
- **Package:** Select ffg900
- **Speed:** Select -2
- **JTAG Chain Position:** Select 1

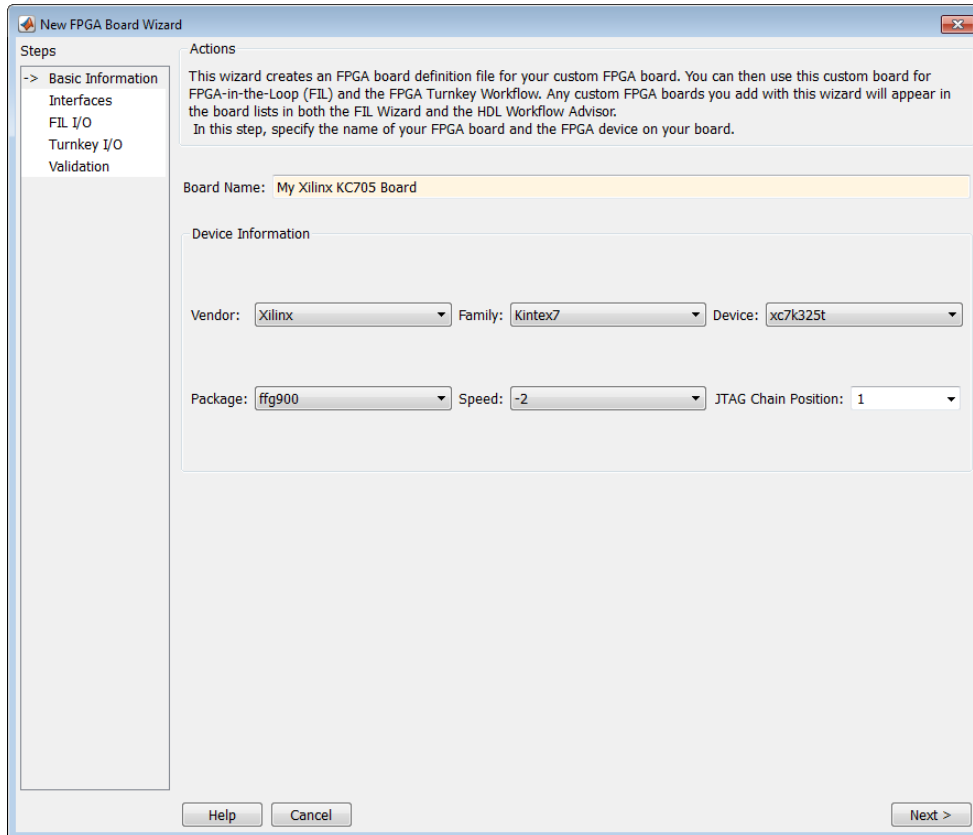

The information you just entered can be found in the KC705 Evaluation Board for the Kintex-7 FPGA User Guide.

- 2 Click Next.

Specify FPGA Interface Information

- 1 In the Interfaces pane, perform the following tasks.
 - a Select **FIL Interface**. This option is required for using your board with FPGA-in-the-loop.
 - b Select **GMII** in the PHY Interface Type. This option indicates that the onboard FPGA is connected to the Ethernet PHY chip via a GMII interface.
 - c Leave the **User-defined I/O** option in the FPGA Turnkey Interface section cleared. FPGA Turnkey workflow is not the focus of this example.
 - d **Clock Frequency:** Enter 200. This Xilinx KC705 board has multiple clock sources. The 200 MHz clock is one of the recommended clock frequencies for use with Ethernet interface (50, 100, 125, and 200 MHz).
 - e **Clock Type:** Select **Differential**.
 - f **Clock_P Pin Number:** Enter AD12.
 - g **Clock_N Pin Number:** Enter AD11.
 - h **Clock IO Standard** — Leave blank.
 - i **Reset Pin Number:** Enter AB7. This value supplies a global reset to the FPGA.
 - j **Active Level:** Select **Active-High**.
 - k **Reset IO Standard** — Leave blank.

You can obtain all necessary information from the board design specification.

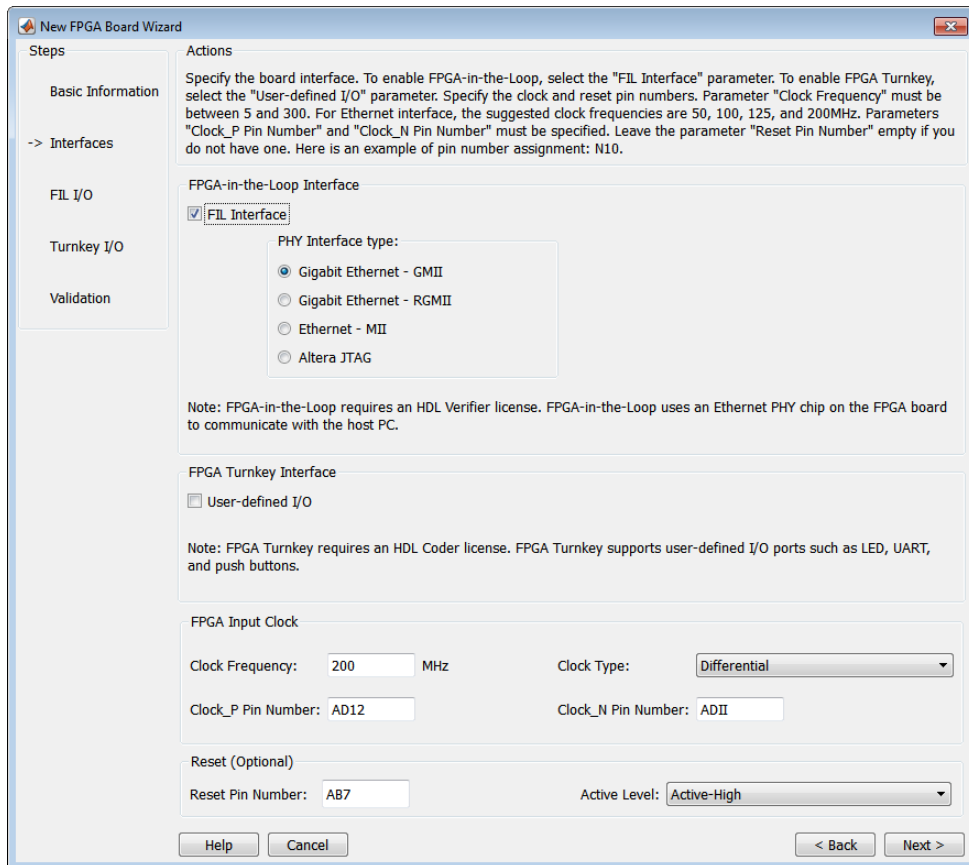

2 Click **Next**.

Enter FPGA Pin Numbers

1 In the FIL I/O pane, enter the numbers for each FPGA pin. This information is required.

Pin numbers for RXD and TXD signals are entered from the least significant digit (LSD) to the most significant digit (MSB), separated by a comma.

For signal name...	Enter FPGA pin number...
ETH_COL	W19
ETH_CRS	R30
ETH_GTXCLK	K30
ETH_MDC	R23
ETH_MDIO	J21
ETH_RESET_n	L20
ETH_RXCLK	U27
ETH_RXD	U30,U25,T25,U28,R19,T27,T26,T28
ETH_RXDV	R28
ETH_RXER	V26
ETH_TXD	N27,N25,M29,L28,J26,K26,L30,J28
ETH_TXEN	M27
ETH_TXER	N29

- 2 Click Advanced Options to expand the section.
- 3 Check the **Generate MDIO module to override PHY settings** option.

This option is selected for the following reasons:

- There are jumpers on the Xilinx KC705 board that configure the Ethernet PHY device to MII, GMII, RGMII, or SGMII mode. Since this example uses the GMII interfaces, the FPGA board does not work if the PHY devices are set to the wrong mode. When the **Generate MDIO module to override PHY settings** option is selected, the FPGA uses the Management Data Input/Output (MDIO) bus to override the jumper settings and configure the PHY chip to the correct GMII mode.
- This option currently only applies to Marvell Alaska PHY device 88E1111 and this KC705 board is using the Marvel device.

- 4 **PHY address (0 – 31):** Enter 7.

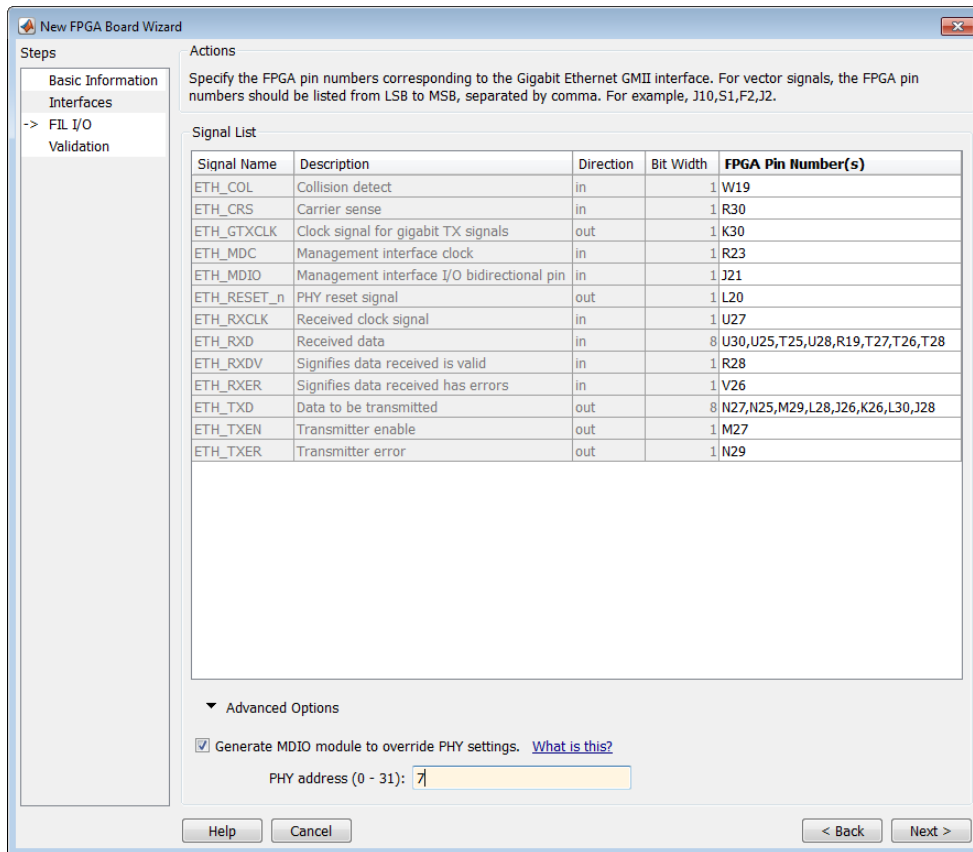

5 Click **Next**.

Run Optional Validation Tests

This step provides a validation test for you to verify if the entered information is correct by performing FPGA-in-the-loop cosimulation. You need Xilinx ISE 13.4 or higher versions installed on the same computer. This step is optional and you can skip it, if you prefer.

Note: For validation, you must have Xilinx or Altera on your path. Use the `hdlsetuptoolpath` function to configure the tool for use with MATLAB.

To run this test, perform the following actions.

- 1 Check the **Run FPGA-in-the-Loop test** option.
- 2 If you have the board attached, check the **Include FPGA board in the test** option. You need to supply the IP address of the FPGA Board. This example assumes that the Xilinx KC705 board is attached to your host computer and it has an IP address of 192.168.0.2.
- 3 Click **Run Selected Test(s)**. The tests take about 10 minutes to complete.

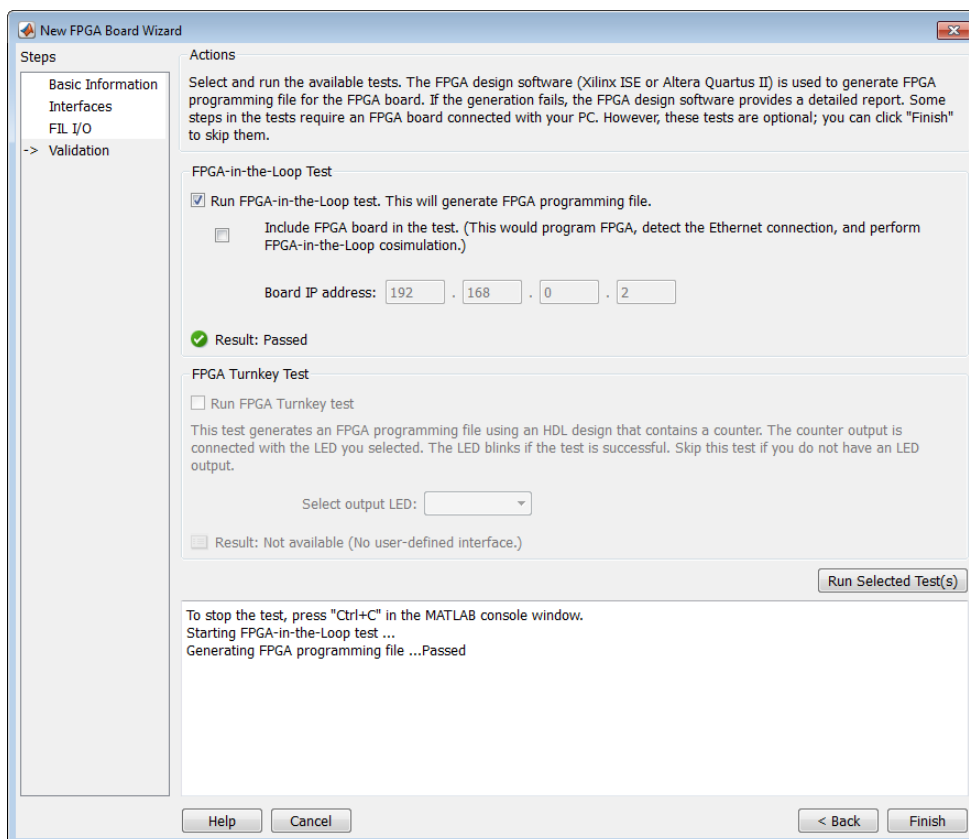

Save Board Definition File

- 1 Click **Finish** to exit the New FPGA Board wizard. A **Save As** dialog box pops up and asks for the location of the FPGA board definition file. For this example, save as `C:\boardfiles\KC705.xml`.

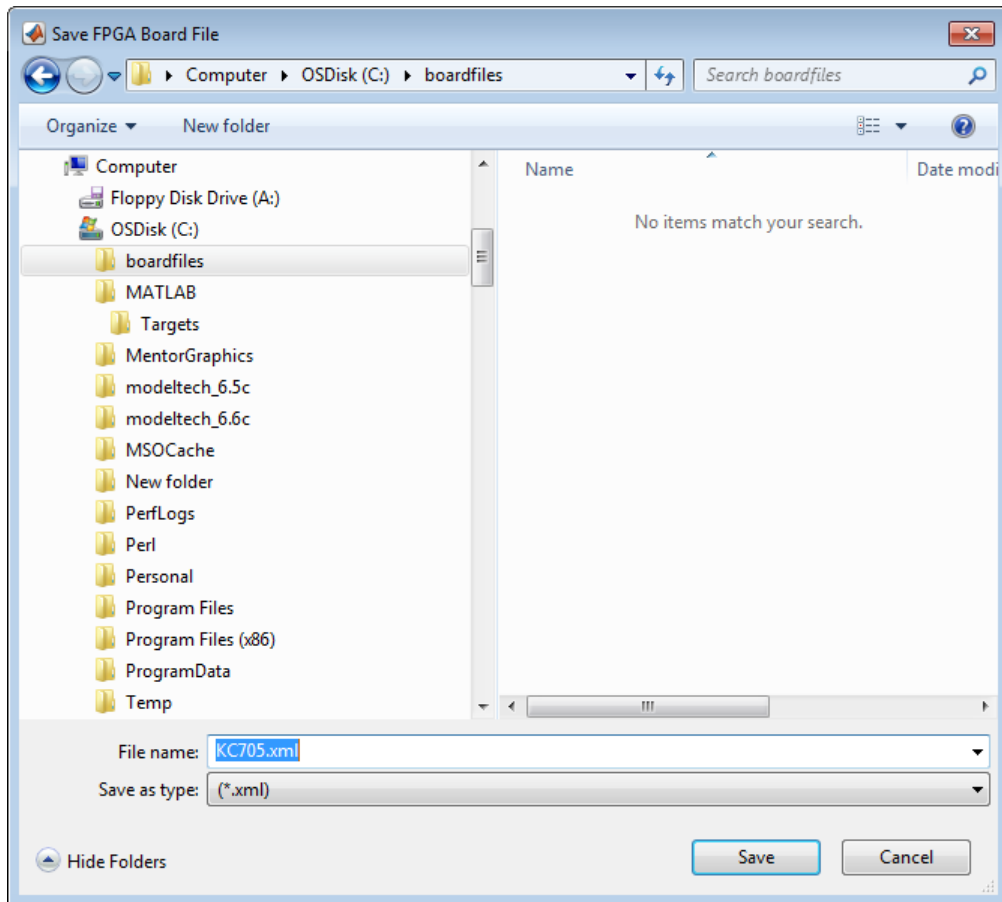

- 2 Click **Save** to save the file and exit.

Use New FPGA Board

- 1 After you save the board definition file, you are returned to the FPGA Board Manager. In the FPGA Board List, you can now see the new board you defined.

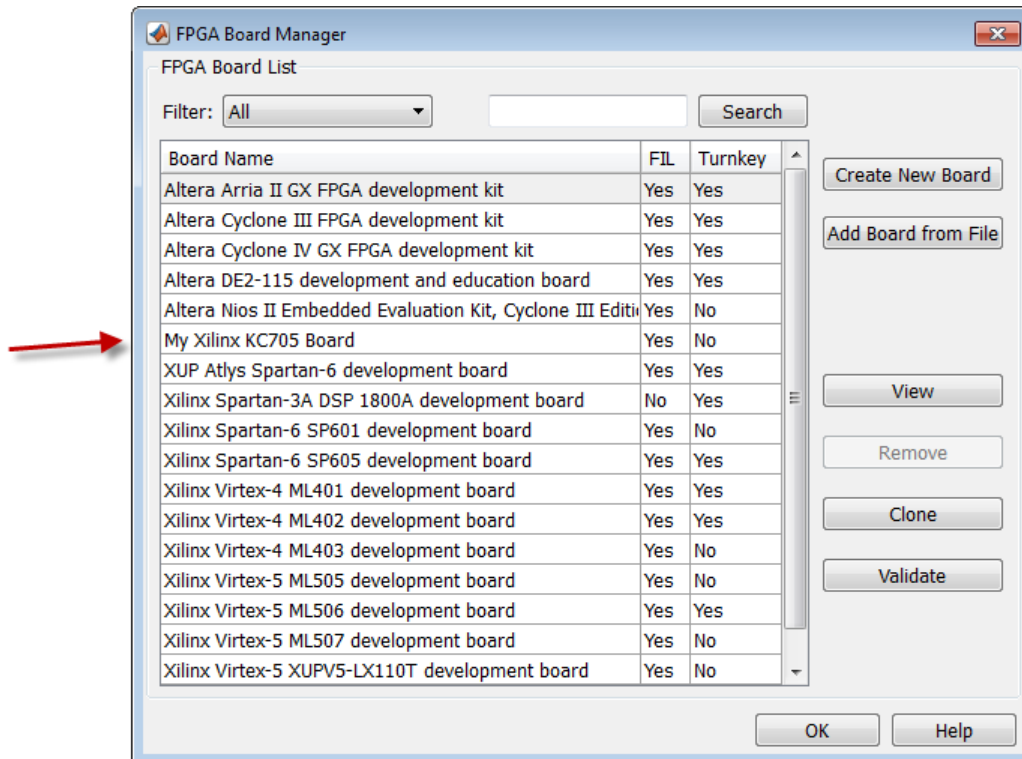

Click **OK** to close the FPGA Board Manager.

- 2 You can view the new board in the board list from either the FIL wizard or the HDL Workflow Advisor.
 - a Start the FIL wizard from the MATLAB prompt.

```
>>filWizard
```

The Xilinx KC705 board appears in the board list and you can select it for FPGA-in-the-loop simulation.

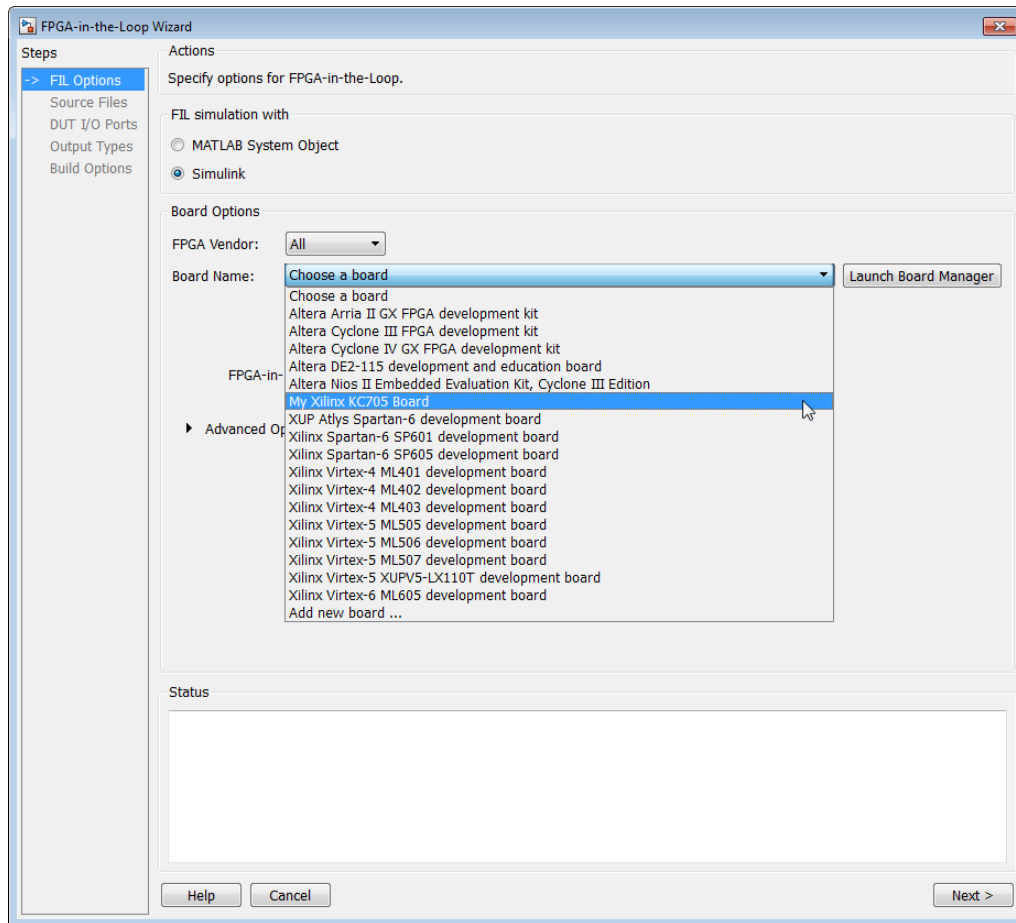

b Start HDL Workflow Advisor.

In step 1.1, select **FPGA-in-the-Loop** and click **Launch Board Manager**.

The Xilinx KC705 board appears in the board list and you can select it for FPGA-in-the-loop simulation.

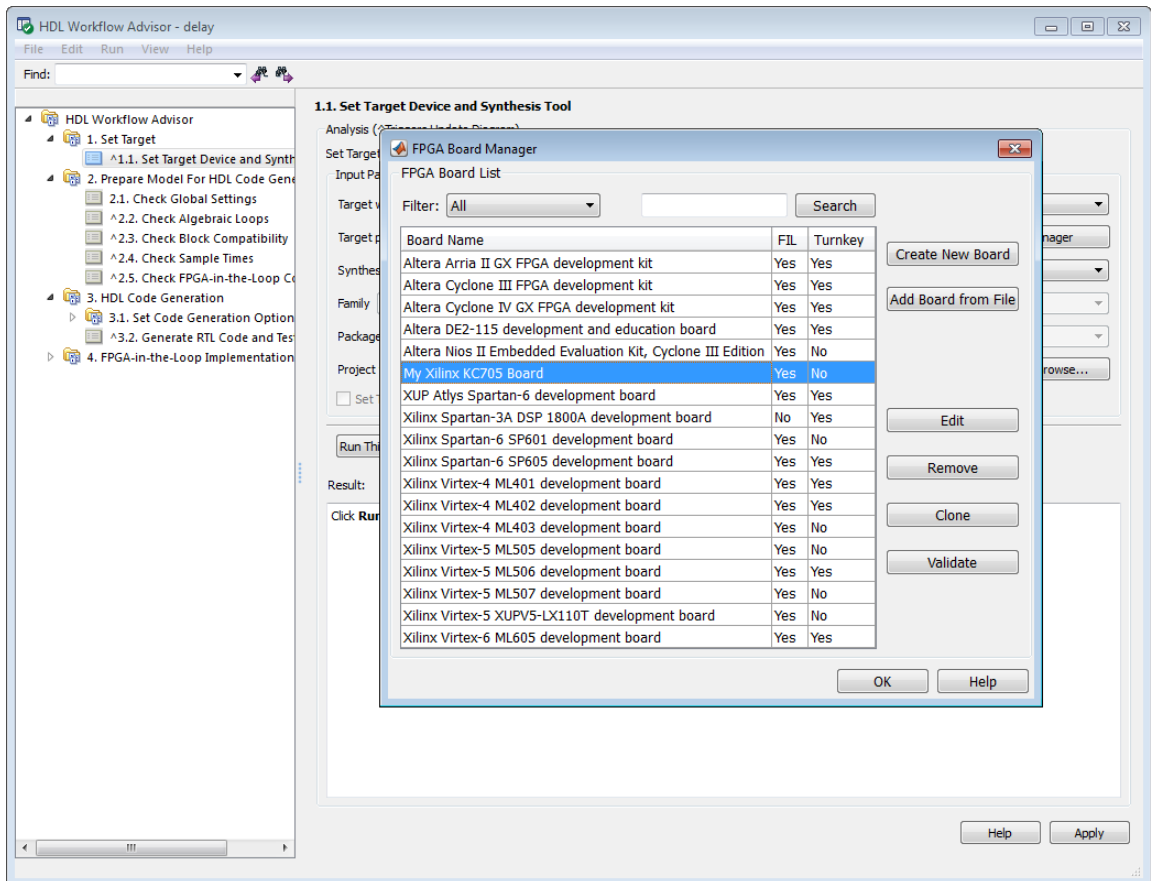

FPGA Board Manager

In this section...

“Introduction” on page 15-21
“Filter” on page 15-23
“Search” on page 15-23
“FIL Enabled/Turnkey Enabled” on page 15-23
“Create Custom Board” on page 15-23
“Add Board from File” on page 15-23
“Get More Boards” on page 15-23
“View/Edit” on page 15-24
“Remove” on page 15-24
“Clone” on page 15-24
“Validate” on page 15-24

Introduction

The FPGA Board Manager is the portal to managing custom FPGA boards. You can create a board definition file or edit an existing one. You can even import a custom board from an existing board definition file.

You start the FPGA Board Manager by one of the following methods:

- By typing `fpgaBoardManager` in the MATLAB command window
- From the FIL wizard by clicking **Launch Board Manager** on the first page
- From the HDL Workflow Advisor (when using HDL Coder) at Step 1.1

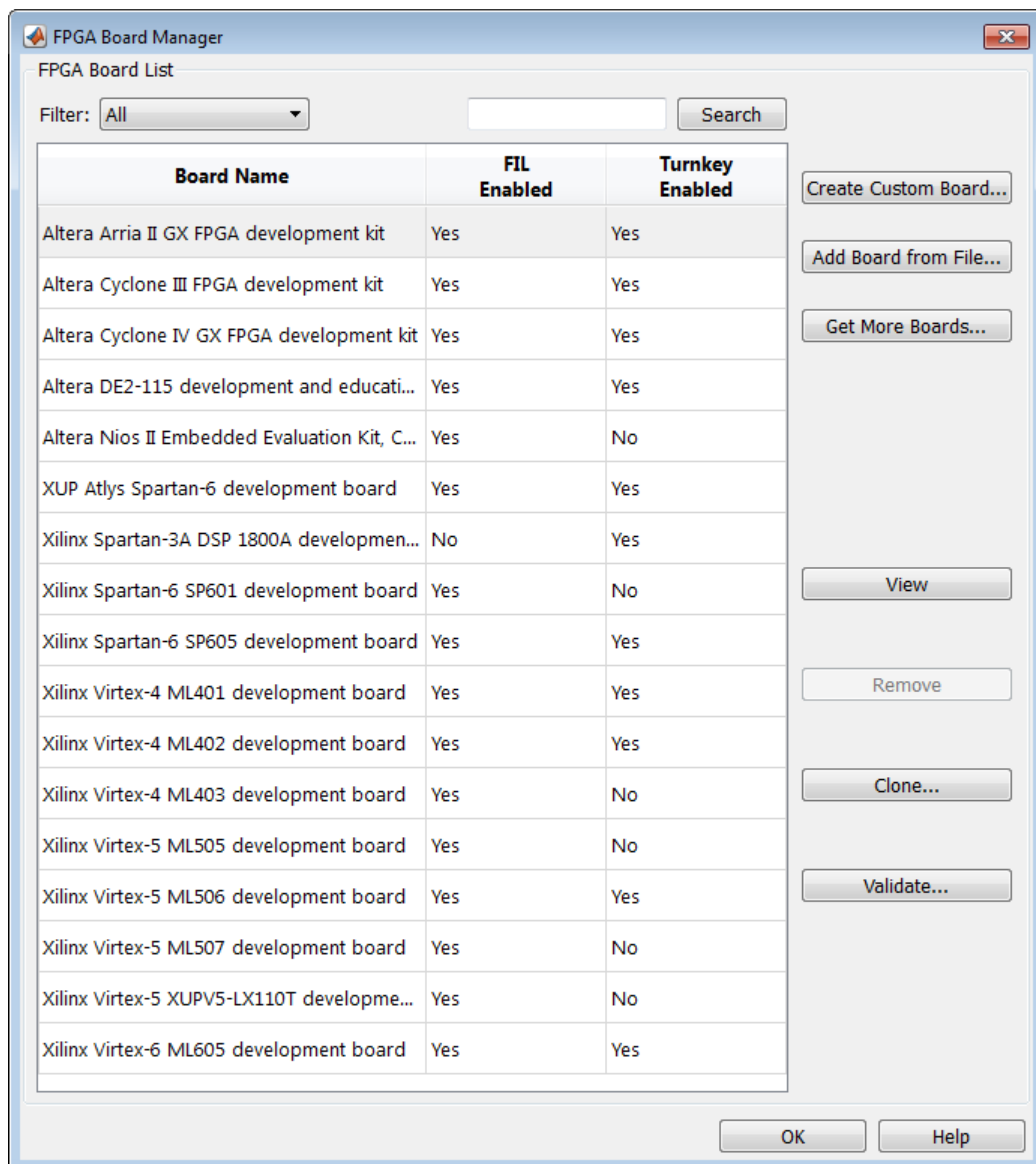

Filter

Choose one of the following views:

- All boards
- Only those boards that were preinstalled with HDL Verifier or HDL Coder
- Only custom boards

Search

Find a specific board in the list or those boards that fully or partially match your search string.

FIL Enabled/Turnkey Enabled

These columns indicate whether the specified board is supported for FIL or Turnkey operations.

Create Custom Board

Start New FPGA Board wizard. See “New FPGA Board Wizard” on page 15-25. You can find the process for creating a board definition file in “Create Custom FPGA Board Definition” on page 15-7.

Add Board from File

Import a board definition file (.xml).

Get More Boards

Download FPGA board support packages for use with FIL

- 1 Click **Get more boards**.
- 2 Follow the prompts in the Support Package Installer to download an FPGA board support package.
- 3 When the download is complete, you can see the new boards in the board list in the FPGA Board Manager.

Offline Support Package Installation You can install an FPGA board support package without an internet connection. See “Install Support Package Offline” on page 10-5.

View/Edit

View board configurations and modify the information. You can view a read-only file but not edit it. See “FPGA Board Editor” on page 15-38.

Remove

Remove custom board from the list. This action does not delete the board definition XML file.

Clone

Makes a copy of an existing custom board for further modification.

Validate

Runs the validation tests for FIL See “Run Optional Validation Tests” on page 15-15.

New FPGA Board Wizard

Using the New FPGA Board wizard, you can enter all the required information to add a board to the FPGA board list. This list applies to both FIL and Turnkey workflows. Review “FPGA Board Requirements” on page 15-3 before adding an FPGA board to make sure that it is compatible with the workflow for which you want to use it.

Several buttons in the New FPGA Board wizard help with navigation:

- **Back:** Go to a previous page to review or edit data already entered.
- **Next:** Go to next page when all requirements of current page have been satisfied.
- **Help:** Open Doc Center, and display this topic.
- **Cancel:** Exit New FPGA Board wizard. You can exit with or without saving the information from your session.

Adding Boards Once for Multiple Users To add new boards globally, follow these instructions. To access a board added globally, all users must be using the same MATLAB installation.

1 Create the following folder:

`matlabroot/toolbox/shared/eda/board/boardfiles`

2 Copy the board description XML file to the `boardfiles` folder.

3 After copying the XML file, restart MATLAB. The new board appears in the FPGA board list for either or both the FIL and Turnkey workflows.

All boards under this folder show-up in the FPGA board list automatically for users with the same MATLAB installation. You do not need to use FPGA Board Manager to add these boards again.

The workflow for adding an FPGA board contains these steps:

In this section...
“Basic Information” on page 15-26
“Interfaces” on page 15-27
“FIL I/O” on page 15-31

In this section...

“Turnkey I/O” on page 15-33

“Validation” on page 15-36

“Finish” on page 15-37

Basic Information

The screenshot shows the 'New FPGA Board Wizard' dialog box, currently on the 'Basic Information' step. The 'Steps' pane on the left lists 'Basic Information', 'Interfaces', 'FIL I/O', 'Turnkey I/O', and 'Validation'. The 'Actions' pane on the right contains the following text: 'This wizard creates an FPGA board description file for your custom FPGA board. You can then use this custom board for FPGA-in-the-Loop (FIL) and the FPGA Turnkey Workflow. Any custom FPGA boards you add with this wizard will appear in the board lists in both the FIL Wizard and the HDL Workflow Advisor. In this step, specify the name of your FPGA board and the FPGA device on your board.'

The 'Board Name' field contains the text 'HDLV Custom Board 1'. The 'Device Information' section contains the following fields:

- Vendor: Xilinx
- Family: Spartan6
- Device: xc6sxc150t
- Package: fgg676
- Speed: -3
- JTAG Chain Position: 1

At the bottom of the dialog box are four buttons: 'Help', 'Close', '< Back', and 'Next >'.

Board Name: Enter a unique board name.

Device Information:

- **Vendor:** Xilinx or Altera

- **Family:** Family depends on the specified vendor. See the board specification file for applicable settings.
- **Device:** Use the board specification file to select the correct device.
- For Xilinx boards only:
 - **Package:** Use the board specification file to select the correct package.
 - **Speed:** Use the board specification file to select the correct speed.
 - **JTAG Chain Position:** Value indicates the starting position for JTAG chain. Consult the board specification file for this information.

Interfaces

- “FIL Interface for Altera Boards” on page 15-27
- “FIL Interface for Xilinx Boards” on page 15-28
- “FPGA Turnkey Interface” on page 15-29
- “FPGA Input Clock and Reset” on page 15-29

FIL Interface for Altera Boards

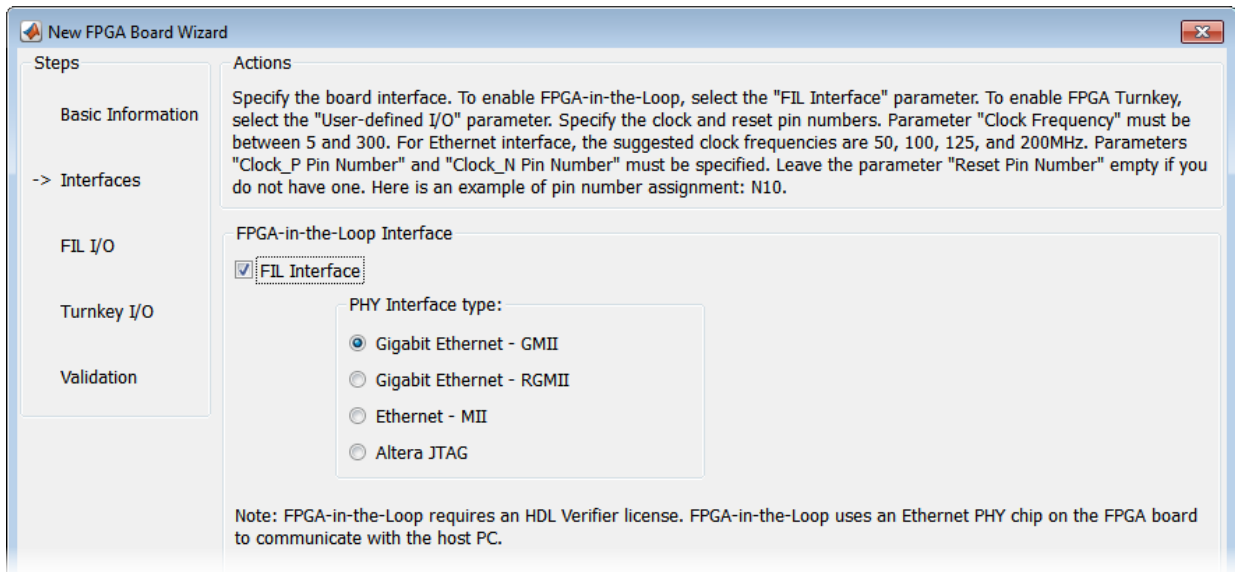

- 1 **FPGA-in-the-Loop:** To use this board with FIL, select **FIL Interface**.
- 2 Select one of the following **PHY Interface types**:
 - **Gigabit Ethernet — GMII**
 - **Gigabit Ethernet — RGMII**
 - **Gigabit Ethernet — SGMII** (the SGMII option appears if you select a board from the Stratix V or Stratix IV device families)
 - **Ethernet — MII**
 - **Altera JTAG** (Altera boards only)

Note: Not all interfaces are available for all boards. Availability depends on the board you selected in Basic Information.

FIL Interface for Xilinx Boards

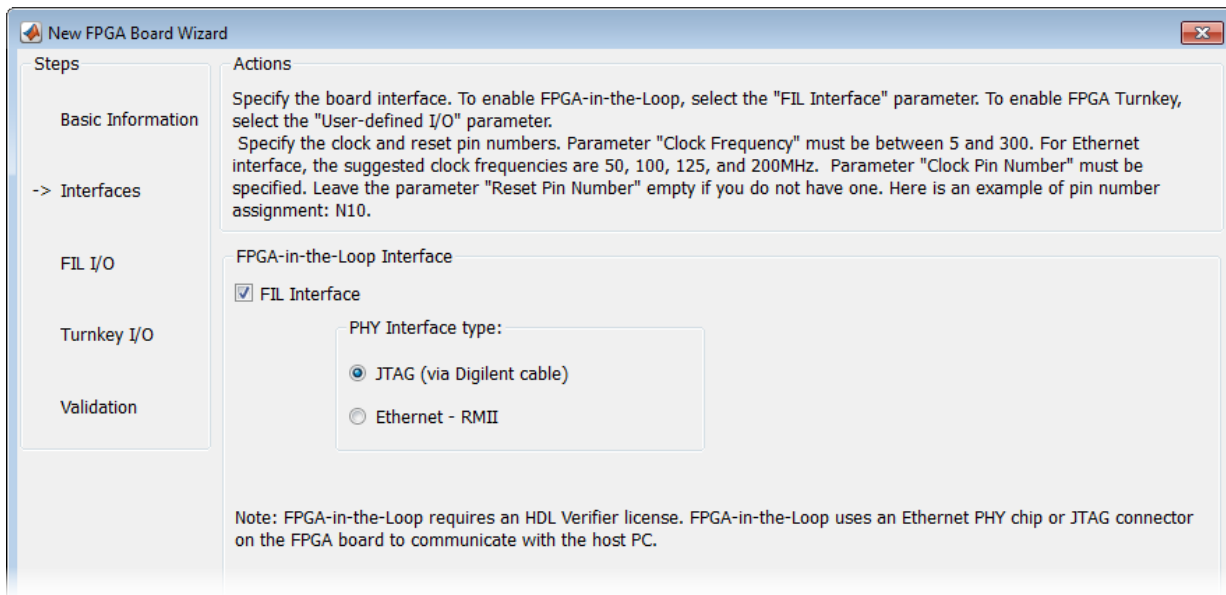

- 1 **FPGA-in-the-Loop Interface:** To use this board with FIL, select **FIL Interface**.
- 2 Select one of the following **PHY Interface types**:

- **JTAG (via Digilent cable)** (Xilinx boards only)
- **Ethernet — RMII**

Note: Not all interfaces are available for all boards. Availability depends on the board you selected in Basic Information.

For more information on how to set up the JTAG connection for Xilinx boards, see “JTAG with Digilent Cable Setup” on page 15-40.

Limitations

When you simulate your FPGA design through a Digilent JTAG cable, you cannot use any other debugging feature that requires access to the JTAG; for example, the Vivado Logic Analyzer.

FPGA Turnkey Interface

FPGA Turnkey Interface

User-defined I/O

Note: FPGA Turnkey requires an HDL Coder license. FPGA Turnkey supports user-defined I/O ports such as LED, UART, and push buttons.

FPGA Turnkey Interface: If you want to use with board with the HDL Coder FPGA Turnkey workflow, select **User-defined I/O**.

FPGA Input Clock and Reset

FPGA Input Clock

Clock Frequency: MHz Clock Type:

Clock_P Pin Number: Clock_N Pin Number:

Clock IO Standard:

Reset (Optional)

Reset Pin Number: Active Level:

Reset IO Standard:

- 1 **FPGA Input Clock** — Clock details are required for both workflows. You can find all necessary information in the board specification file.
 - **Clock Frequency** — Must be from 5 through 300. For an Ethernet interface, the suggested clock frequencies are 50, 100, 125, and 200 MHz.
 - **Clock Type** — `Single_Ended` or `Differential`.
 - **Clock Pin Number** (`Single_Ended`) — Must be specified. Example: N10.
 - **Clock_P Pin Number** (`Differential`) — Must be specified. Example: E19.
 - **Clock_N Pin Number** (`Differential`) — Must be specified. Example: E18.
 - **Clock IO Standard** — The programmable I/O Standard to use to configure input, output, or bi-directional ports. For example, LVDS.
- 2 **Reset (Optional)** — If you want to indicate a reset, find the pin number and active level in the board specification file, and enter that information.
 - **Reset Pin Number** — Leave empty if you do not have one.
 - **Active Level** — `Active-Low` or `Active-High`.
 - **Reset IO Standard** — The programmable I/O Standard to use to configure input, output, or bi-directional ports. For example, LVCMOS33.

FIL I/O

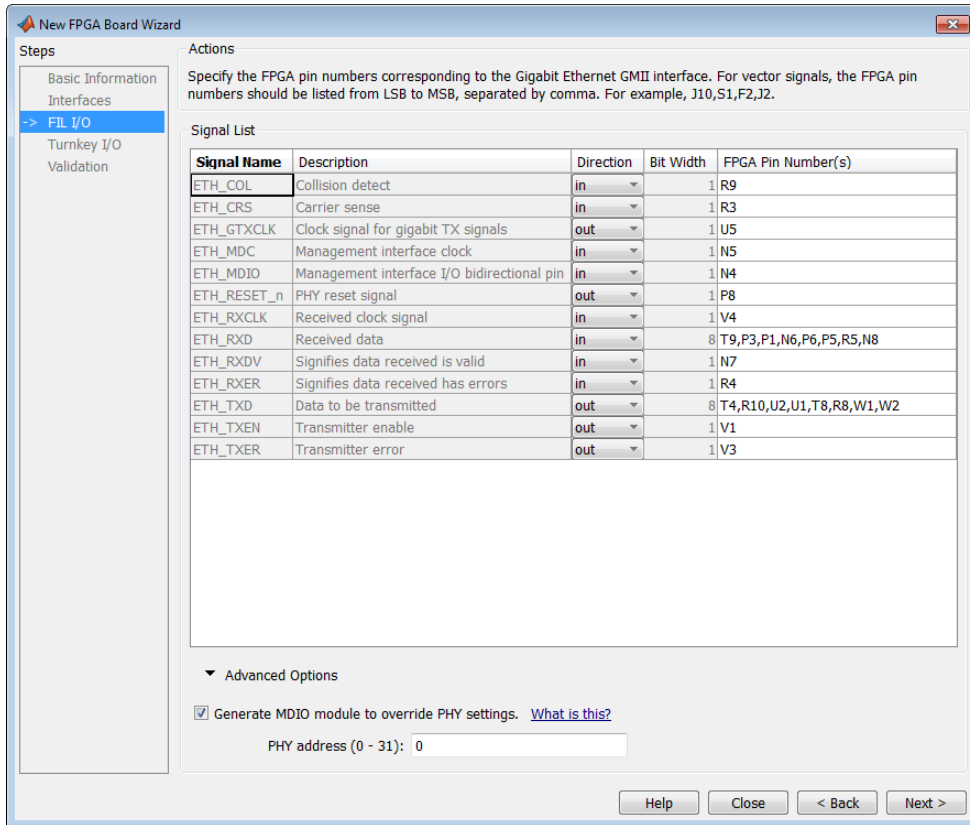

Note: You provide FIL I/O for an Ethernet connection only.

Signal List: Provide all the FPGA pin numbers for the specified signals. You can find this information in the board specification file. For vector signals, list all pin numbers on the same line, separated by commas.

Generate MDIO module to override PHY settings: See the next section on FPGA Board Management Data Input/Output Bus (MDIO) to determine when to use this feature. If you do select this option, enter the PHY address.

What Is the Management Data Input/Output Bus?

Management Data Input/Output (MDIO) is a serial bus, defined in the IEEE[®] 802.3 standard, that connects MAC devices and Ethernet PHY devices. The FPGA MAC uses the MDIO bus to set control registers in the Ethernet PHY device on the board.

Currently only the Marvell 88E1111 PHY chip is supported by this MDIO module implementation. Do not select this check box if you are not using Marvell 88E1111.

The generated MDIO module is used to perform the following operations:

- **GMII mode:** The PHY device can start up using other modes, such as RGMII/SGMII. The generated MDIO module sets the PHY chip in GMII mode.
- **RGMII mode:** The PHY device can start up using other modes, such as GMII/SGMII. The generated MDIO module sets the PHY device in RGMII mode. In addition, the module sets the PHY chip to add internal delay for RX and TX clocks.
- **SGMII mode:** The PHY device can start up using other modes, such as RGMII/GMII. The generated MDIO module sets the PHY chip in SGMII mode.
- **MII mode:** The generated MDIO module sets the PHY device in GMII compatible mode. The module also sets the autonegotiation register to remove the 1000 Base-T capability advertisement. This reset ensures that the autonegotiation process does not select 1000 Mbits/s speed, which is not supported in MII mode.

When To Select MDIO: Select the **Generate MDIO module to override PHY settings** option when both the following conditions are met:

- The onboard Ethernet PHY device is Marvell 88E1111.
- The PHY device startup settings are not compatible with the FPGA MAC. The MDIO modules for different PHY modes must override these settings, as previously described.

Specifying the PHY Address: The PHY address is a 5-bit integer. The value is determined by the CONFIG[0] and CONFIG[1] pin on Marvell 88E1111 PHY device. See the board manual for this value.

Turnkey I/O

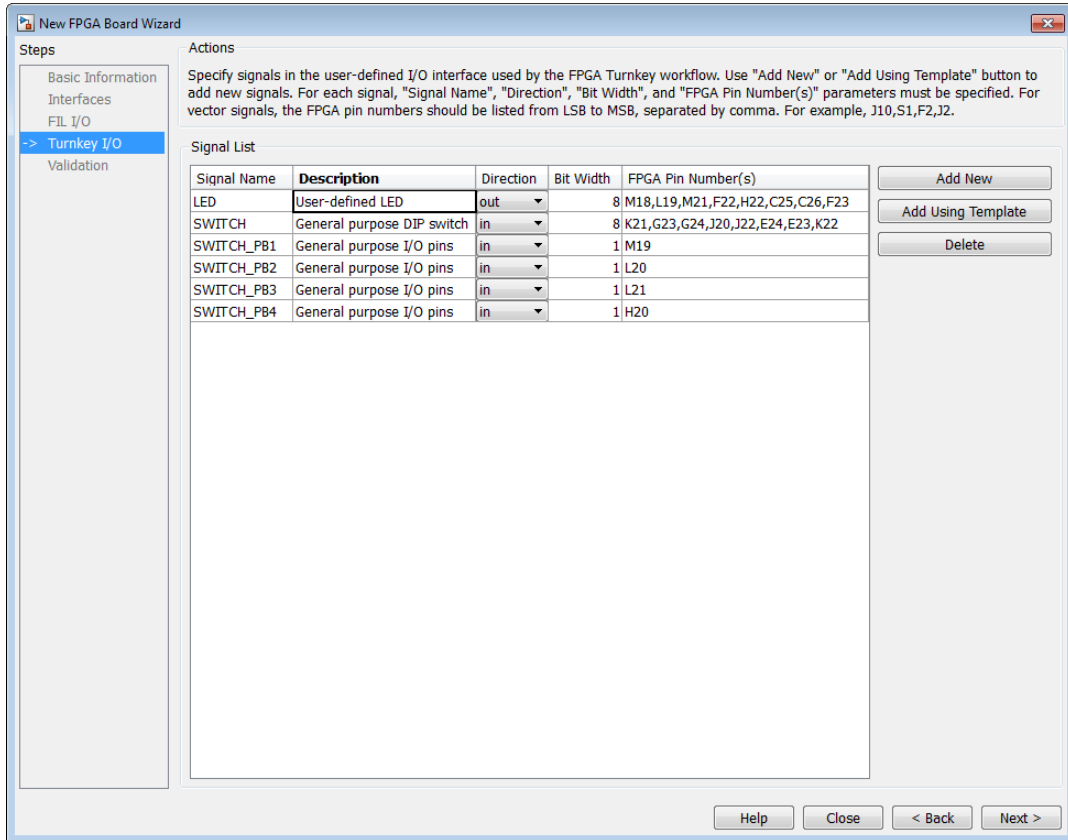

Note: Provide FIL I/O for an Ethernet connection only. Define at least one output port for the Turnkey I/O interface.

Signal List: Provide all the FPGA pin numbers for the specified signals. You can find this information in the board specification file. For vector signals, list all pin numbers on the same line, separated by commas. The number of pin numbers must match the bit width of the corresponding signal.

Add New: You are prompted to enter all entries in the signal list manually.

Add Using Template: The wizard prepopulates a new signal entry for UART, LED, GPIO, or DIP Switch signals with the following:

- A generic signal name
- Description
- Direction
- Bit width

You can change the values in any of these prepopulated fields.

Delete: Delete the selected signal from list.

The following example demonstrates using the **Add Using Template** feature.

- 1 In the Turnkey I/O dialog box, click **Add Using Template**.
- 2 You can now view the template dialog box.

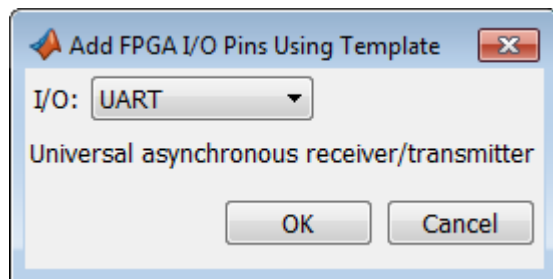

- 3 Pull down the I/O list and select from the following options:

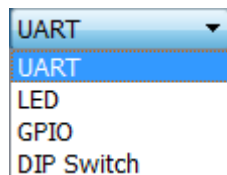

- 4 Click **OK**.
- 5 The wizard adds the specified signal (or signals) to the I/O list.

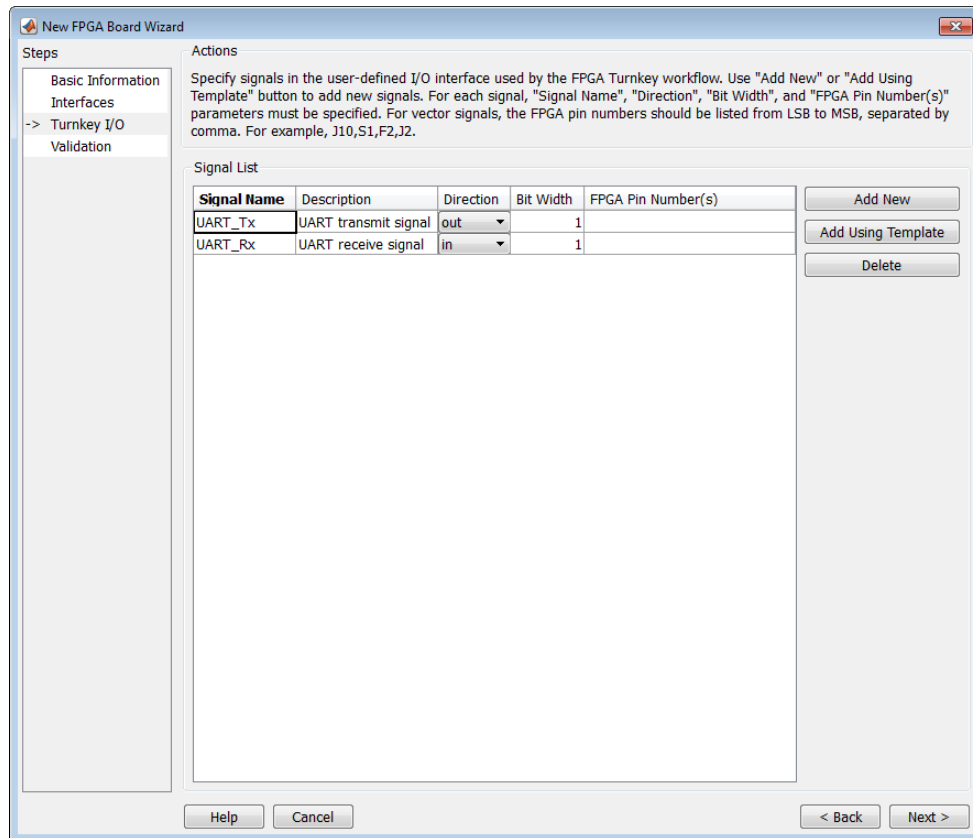

Validation

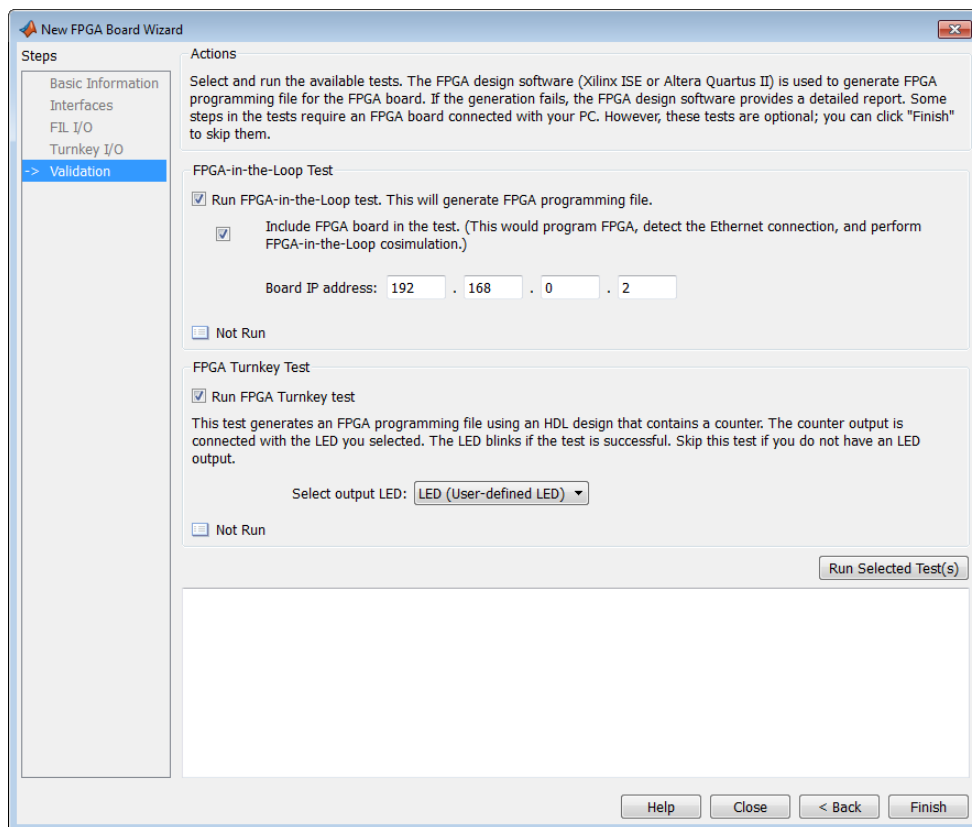

FPGA-in-the-Loop Test

- **Run FPGA-in-the-Loop test:** Select to generate an FPGA programming file.
 - **Include FPGA board in the test:** (Optional) This selection program the FPGA with the generated programming file, detects the Ethernet connection (if selected), and performs FPGA-in-the-loop simulation.
 - **Board IP address:** (Ethernet connection only) Use this option for setting the board IP address if it is not the default IP address (192.168.0.2).

If necessary, change the computer IP address to a different subnet from 192.168.0.x when you set up the network adapter. If the default board IP address

192.168.0.2 is in use by another device, change the Board IP address according to the following guidelines:

- The subnet address, typically the first 3 bytes of board IP address, must be the same as the host IP address.
- The last byte of the board IP address must be different from the host IP address.
- The board IP address must not conflict with the IP addresses of other computers.

For example, if the host IP address is 192.168.8.2, then you can use 192.168.8.3, if available.

FPGA Turnkey Test

- **Run FPGA Turnkey test:** Select to generate an FPGA programming file using an HDL design that contains a counter. You must have a board attached.
- **Select output LED:** The counter's output is connected with the LED you select. Skip this test if you do not have an LED output.

Finish

When you have completed validation, click **Finish**. See “Save Board Definition File” on page 15-17.

FPGA Board Editor

To edit a board definition XML file, first make it writeable. If the file is read-only, the FPGA Board Editor only lets you view the board configuration information. You cannot modify that information.

In this section...

“General Tab” on page 15-38

“Interface Tab” on page 15-40

General Tab

The screenshot shows the 'General' tab of the FPGA Board Editor. The window title is 'Xilinx Virtex-7 VC707 development board - Copy (S:\Xilinx_pcie\zedboard\camera\matlab\new...'. The 'Action' section contains the text 'Specify your FPGA board information.' Below this are two tabs: 'General' and 'Interface', with 'Interface' selected. The main area contains the following fields:

- Board Name:** My Xilinx Virtex-7 VC707 development board
- File Location:** S:\Xilinx_pcie\zedboard\camera\matlab\newboard - Copy.xml
- Device Information:**
 - Vendor: Xilinx
 - Family: Virtex7
 - Device: xc7vx485t
 - Package: ffg1761
 - Speed: -2
 - JTAG Chain Position: 1
- FPGA Input Clock:**
 - Clock Frequency: 200 MHz
 - Clock Type: Differential
 - Clock_P Pin Number: E19
 - Clock_N Pin Number: E18
 - Clock IO Standard: LVDS
- Reset (Optional):**
 - Reset Pin Number: AV40
 - Active Level: Active-High
 - Reset IO Standard: LVCMOS18

At the bottom of the dialog are four buttons: OK, Cancel, Help, and Apply.

Board Name: Unique board name

Device Information:

- **Vendor:** Xilinx or Altera
- **Family:** Family depends on the specified vendor. See the board specification file for applicable settings.
- **Device:** Device depends on the specified vendor and family. See the board specification file for applicable settings.
- For Xilinx boards only:
 - **Package:** Package depends on specified vendor, family, and device. See the board specification file for applicable settings.
 - **Speed:** Speed depends on package. See the board specification file for applicable settings.
 - **JTAG Chain Position:** Value indicates the starting position for JTAG chain. Consult the board specification file for this information.
- **FPGA Input Clock.** Clock details are required for both the FIL and Turnkey workflows. You can find all necessary information in the board specification file.
 - **Clock Frequency.** Must be from 5 through 300. For an Ethernet interface, the suggested clock frequencies are 50, 100, 125, and 200 MHz.
 - **Clock Type:** Single_Ended or Differential.
 - **Clock Pin Number** (Single_Ended) — Must be specified. Example: N10.
 - **Clock_P Pin Number** (Differential) — Must be specified. Example: E19.
 - **Clock_N Pin Number** (Differential) — Must be specified. Example: E18.
 - **Clock IO Standard** — The programmable I/O Standard to use to configure input, output, or bi-directional ports. For example, LVDS.
- **Reset (Optional).** If you want to indicate a reset, find the pin number and active level in the board specification file, and enter that information.
 - **Reset Pin Number.** Leave empty if you do not have one.
 - **Active Level :** Active-Low or Active-High.
 - **Reset IO Standard** — The programmable I/O Standard to use to configure input, output, or bi-directional ports. For example, LVCMOS33.

Interface Tab

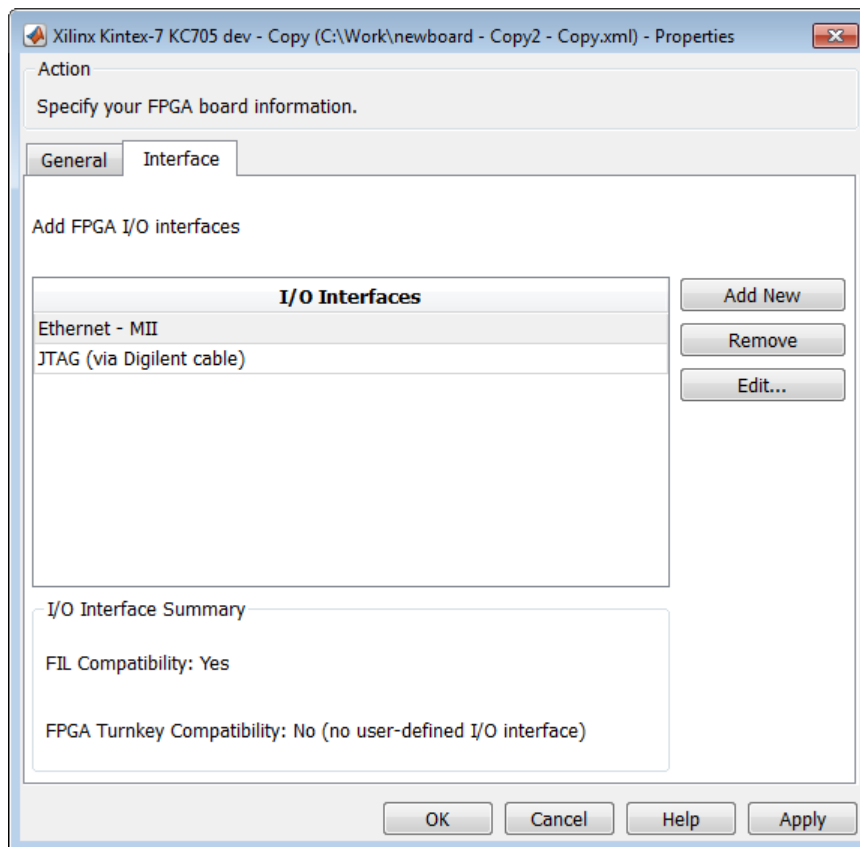

The Interface page describes the supported FPGA I/O Interfaces. Select any listed interface and click **View** to see the **Signal List**. If the board definition file has write permission, you can also **Add New** interface, **Edit** the interface, or **Remove** an interface.

JTAG with Digilent Cable Setup

Note: Enter information for the JTAG cable setup carefully. If the settings are incorrect, the simulation errors out and does not work. If you are still unsure about how to setup

your JTAG cable after reading these instructions, contact MathWorks technical support with detailed information about your board.

JTAG (via Digilent cable)

Action

Specify the instruction register (IR) lengths for

(a) The sum of IR lengths for devices before FPGA in the chain

(b) The sum of IR lengths for devices after FPGA in the chain

Signal/Parameter List

Sum of IR length before:

Sum of IR lengths after:

Example:

Diagram illustrating a JTAG chain configuration:

```

graph LR
    TDI --- DeviceA[Device A  
IR  
IR Length=4]
    DeviceA --- TDO --- TDI --- FPGA[FPGA  
IR]
    FPGA --- TDO --- TDI --- DeviceB[Device B  
IR  
IR Length=3]
    DeviceB --- TDO --- TDI --- DeviceC[Device C  
IR  
IR Length=2]
    DeviceC --- TDO
  
```

An example of JTAG chain configuration is shown in the above figure. Assume that the instruction register lengths are Device A: 4, Device B: 3, Device C: 2. Then the answers are:

(a) Sum of IR lengths before = 4

(b) Sum of IR lengths after = 3+2 = 5

If the FPGA is the only device on the chain, enter 0 for both fields. To find more information regarding JTAG chain configuration, please click "Help" button.

Advanced Options

User1 Instruction:

JTAG Clock Frequency (MHz):

OK Cancel Help Apply

1 Signal/Parameter List — Provide the sum of the lengths of the instruction registers (IR) for all devices before and after the FPGA in the chain.

- If the FPGA is the only item in the device chain, use zeros in both **Sum of IR length before** and **Sum of IR length after**.
- If you are using a Zynq device, and it is the only item in the device chain, enter 4 in **Sum of IR length before** and 0 in **Sum of IR length after**.

If your board does not meet either of those conditions, follow these instructions to obtain the IR lengths:

SystemC TLM Generation

How TLM Component Generation Works

- “TLM Generation Algorithms” on page 16-2
- “The TLM Generation Process” on page 16-4
- “Generated TLM Files” on page 16-6

TLM Generation Algorithms

The algorithm you use to generate the TLM component can be made of any combination of Simulink blocks that can generate C code. These blocks generally belong to a subsystem. Simulink Coder™ software generates ANSI C code from those blocks that HDL Verifier software then customizes with the settings specified using the TLM component generator to create the files that make up the virtual platform model. For an example of how this process works, see the following illustration.

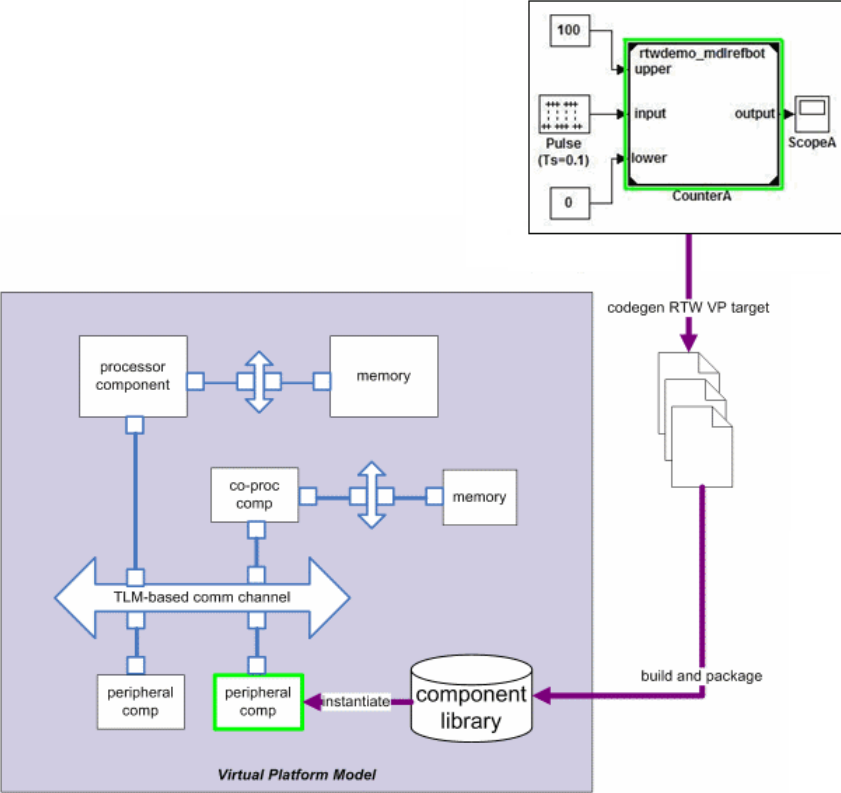

The TLM Generation Process

After you obtain the TLM component files generated by HDL Verifier software, you can compile the TLM component and the optional test bench with OSCI SystemC libraries and the OSCI TLM libraries. To do so, use the makefile supplied by HDL Verifier to create your virtual platform executable (e.g., mysimulation.exe).

The following diagram illustrates the complete set of articles you can generate including the TLM component, the TLM component test bench, and the set of test vectors to be executed by the test bench. Simulink generates these vectors while performing model execution when you verify the TLM component from within Simulink (see “Run TLM Component Test Bench” on page 20-7).

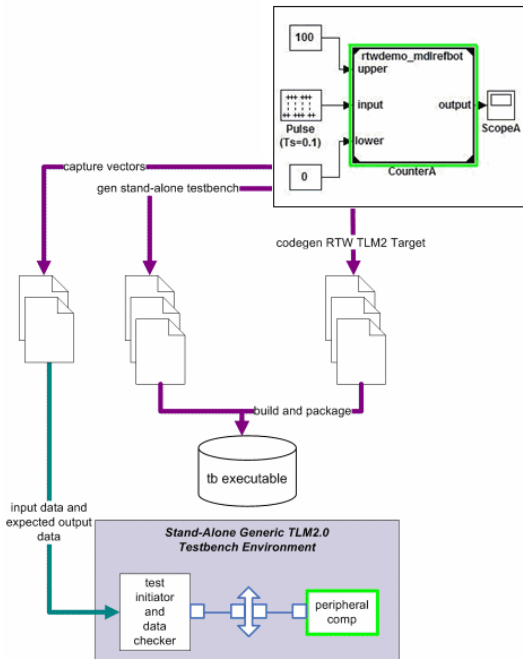

The following general workflow describes the process for creating an OCSI-compatible TLM component representing the Simulink algorithm:

- 1** Create Simulink model representing algorithm.
- 2** Select required architectural model (i.e., virtual platform model) parameters via the Simulink Configuration Parameters dialog box. See “Subsystem Guidelines and Limitations” on page 19-3.
- 3** (Optional) If you want, restore any desired configuration sets at this time. Because the topic of configuration sets is outside the scope of this workflow description, refer to the section "Overview of Model Referencing" in the Simulink documentation.
- 4** Initiate code generation.
- 5** Save configuration options with model for future use.

Generated TLM Files

HDL Verifier software generates the following files:

- C/C++ code containing the Simulink model behavior (.cpp and .h files)
- Virtual platform TLM component class (.cpp and .h files)
- TLM component documentation (HTML)
- TLM component test bench (if specified) (.cpp and .h files)
- Test bench stimulus and expected response vectors (MATLAB formatted data)
- Makefiles for building the TLM component and standalone test bench (makefile format)
- IP-XACT XML file. For details, see “Contents of Generated IP-XACT File” on page 19-29.

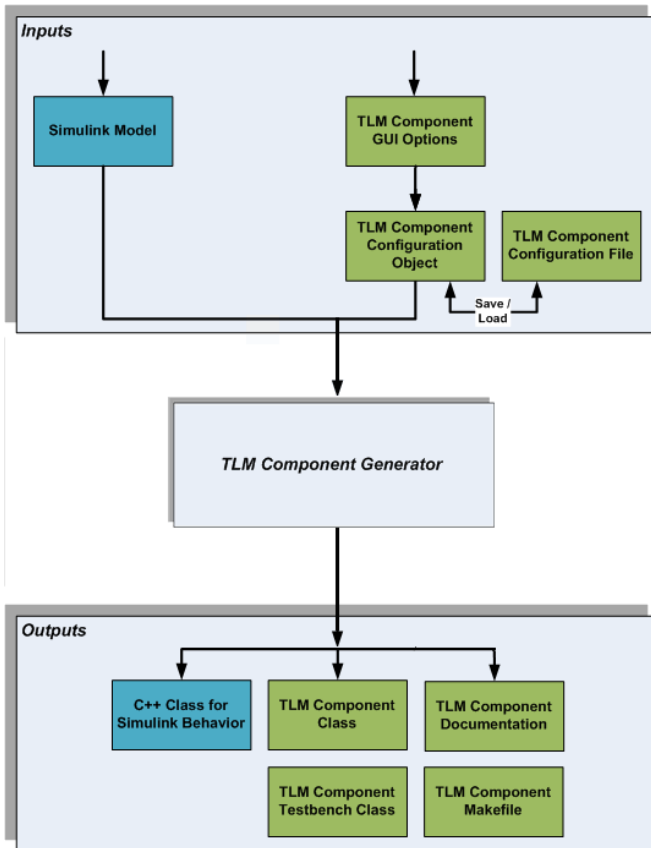

After code generation is complete, you can then use these generated files (outputs) to create the standalone TLM executable. See “Export TLM Component” on page 21-5.

TLM Component Architecture

TLM Component Architecture

In this section...

“Overview of Component Features” on page 17-2

“Single or Multiple Sockets” on page 17-5

“Memory Mapping” on page 17-5

“Command and Status Register” on page 17-10

“Interrupt” on page 17-17

“Test and Set Register” on page 17-17

“Tunable Parameter Registers” on page 17-18

“Algorithm Execution” on page 17-18

“Register and Buffering” on page 17-18

“Temporal Decoupling” on page 17-20

“TLM Component Timing Values” on page 17-25

“TLM Component Naming and Packaging” on page 17-26

Overview of Component Features

The TLM generator exports a target TLM component from a Simulink model subsystem. The target TLM component has a single TLM socket that supports read and write transactions using the TLM generic protocol and generic payload.

The following diagram illustrates the simplest behavior you can specify for the generated TLM component. It contains no memory map or command and status register and executes transactions immediately.

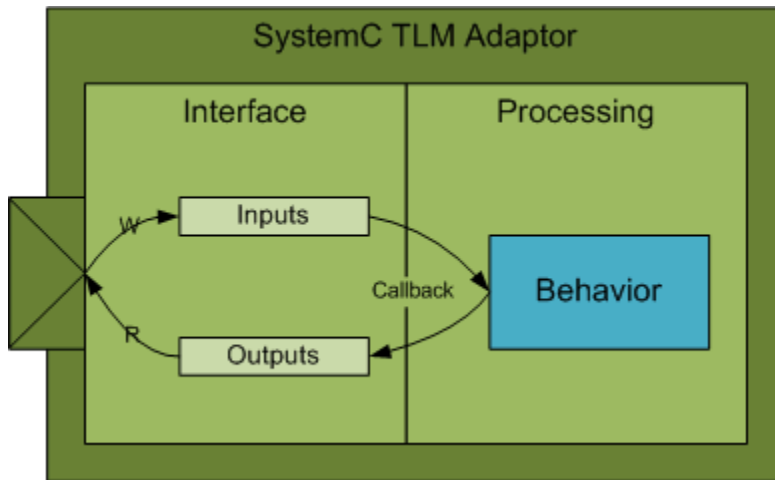

There are a number of options you can use to control the architecture of the generated TLM component. Incorporating a memory map is one of the most effective options. The following figure demonstrates the behavior of a generated TLM component with a full complement of features enabled.

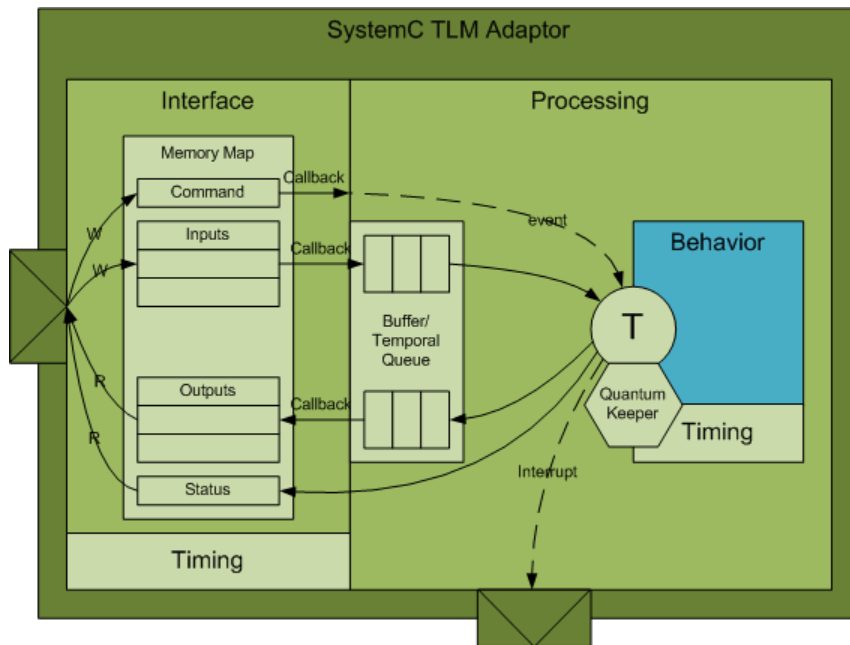

You can set options for the following TLM component features:

- “Single or Multiple Sockets” on page 17-5
- “Memory Mapping” on page 17-5
 - No memory map
 - Automatically generated memory map with single address
 - Automatically generated memory map with individual addresses
- “Command and Status Register” on page 17-10
- “Interrupt” on page 17-17
- “Test and Set Register” on page 17-17
- “Tunable Parameter Registers” on page 17-18
- “Algorithm Execution” on page 17-18
- “Register and Buffering” on page 17-18
- “Temporal Decoupling” on page 17-20
- “TLM Component Timing Values” on page 17-25

- “TLM Component Naming and Packaging” on page 17-26

Single or Multiple Sockets

You can choose to have a single, combined TLM socket for input data, output data, and control or you can choose three separate TLM socket for input data, output data, and control so that you can connect the sockets to different buses.

Memory Mapping

- “No Memory Map” on page 17-5
- “Automatically Generated Memory Map with Single Address” on page 17-6
- “Automatically Generated Memory Map with Individual Addresses” on page 17-8

No Memory Map

The no memory map option generates a TLM component with only one read and one write register without any address. The Simulink model inputs are represented by the write register and the outputs are represented by the read register.

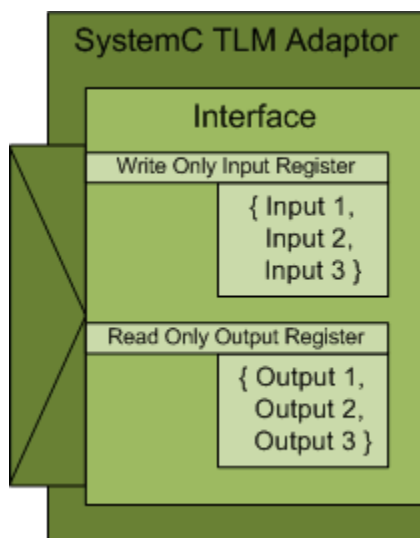

TLM Generic Payload			
Command	Address	Length	Data
Write	N/A	Input Reg. Size	{ Input 1, Input 2, Input 3 }
Read		Output Reg. Size	{ Output 1, Output 2, Output 3 }

Without a memory map, the generated TLM component has the following characteristics:

- Has a single input register and a single output register.
- Does not need—and ignores—an address in the read and write requests during SystemC simulation to select specific registers on the device.
 - Receives all input data in a single write request, and a read request receives all output data in the return value
- Has input and output registers either sized to hold an entire data set required or created by the TLM component when it executes the behavior (algorithm step function) in your virtual platform environment
- When input registers are full, this condition triggers (schedules) execution of the behavior in the SystemC simulator. Output registers are handled the same way.
- All defaults for commands and status are applied.

When you generate the TLM component with this option, you can use it in a virtual platform (VP) as:

- A standalone component in a verification test bench
- A direct bound co-processing unit
- A device attached to a communication channel using a protocol adapter

Automatically Generated Memory Map with Single Address

The automatically generated memory map with single address option generates a TLM component with only one read data register and one write data register with one address each.

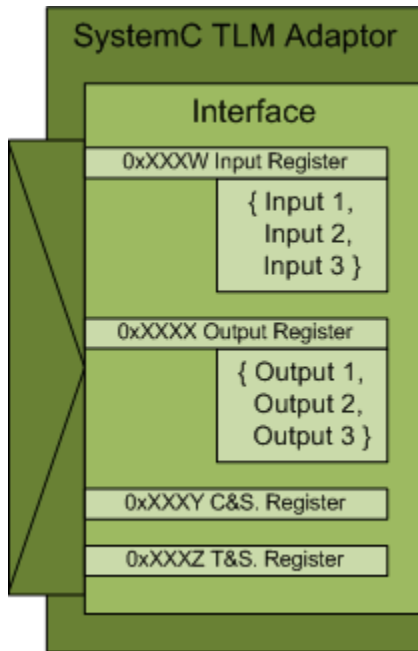

TLM Generic Payload			
Command	Address	Length	Data
Write	0xXXXW	Input Reg. Size	{ Input 1, Input 2, Input 3 }
Read	0XXXX	Output Reg. Size	{ Output 1, Output 2, Output 3 }
Read/Write	0XXXXY	CSR Reg. Size	Command & Status Reg. Data
Read/Write	0XXXXZ	TSR Reg. Size	Test & Set Reg. Data

The Simulink model inputs are represented by the write register, and the outputs are represented by the read register. HDL Verifier software automatically assigns the addresses required to access those specific registers during code generation. Those addresses give the specific offsets required to address each individual register via read and write operations. Definition of the base address for the entire generated TLM component should be defined by the virtual platform that the TLM component resides in.

The offset address definitions appear in a definition file that is generated along with the TLM component.

With a single address memory map, the generated TLM component has the following characteristics:

- Has a single input register and a single output register, and optional command and status register and test and set register.
- Must have an address in the read and write requests during SystemC simulation to select specific registers on the device.
 - Receives all input data in a single write request, and a read request receives all output data in the return value
- Has input and output registers either sized to hold an entire data set required or created by the TLM component when it executes the behavior (algorithm step function) in your virtual platform environment
- If a command and status register is not used or if the command and status register is used and the default values apply, when input register is full, content is pushed into buffer, which then triggers (schedules) execution of the behavior in the SystemC simulator. If the command and status register is used and the Push Input Command is set to 1, the initiator module moves the input data set from the input register to the input buffer. Output registers are handled the same way.
- If a command and status register is not used, all defaults for commands and status are applied.

When you generate the TLM component with this option, you can use it in a virtual platform (VP) as a standalone component in a test bench, or you can attach it to a communication channel.

Automatically Generated Memory Map with Individual Addresses

The automatically generated memory map with individual address option generates a TLM component with one read data register per model output and write data register per model input with individual addresses.

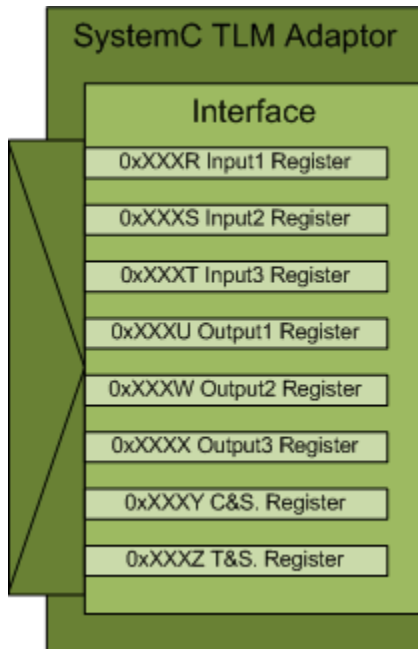

TLM Generic Payload			
Command	Address	Length	Data
Write	0xFFFF	Input1 Reg. Size	Input 1 Data
Write	0xFFFFS	Input2 Reg. Size	Input 2 Data
Write	0xFFFFT	Input3 Reg. Size	Input 3 Data
Read	0xFFFFU	Output1 Reg. Size	Output 1 Data
Read	0xFFFFW	Output2 Reg. Size	Output 2 Data
Read	0xFFFFX	Output3 Reg. Size	Output 3 Data
Read/Write	0xFFFFY	CSR Reg. Size	Command & Status Reg. Data
Read/Write	0xFFFFZ	TSR Reg. Size	Test & Set Reg. Data

Each Simulink model input is represented by its corresponding write register, and each output is represented by its corresponding read register. HDL Verifier software automatically assigns the addresses required to access those specific registers during code generation. Those addresses give the specific offsets required to address each individual register via read and write operations. Definition of the base address for the entire generated TLM component should be defined by the virtual platform that the TLM component resides in. The offset address definitions appear in a definition file that is generated along with the TLM component.

With an individual address memory map, the generated TLM component has the following characteristics:

- Each input register and each output register has its own address as well as an optional command and status register and test and set register.
- Must have an address in the read and write requests during SystemC simulation to select specific registers on the device.
 - Each input and output register must be accessed individually.
- Initiator module can write or read each input and output register in multiple and/or partial transactions.
- The size of each input and output register is the size of the data.
- Execution is triggered when all input has been written or when command and set register bits are set to Automatic. If set to manual, the initiator module moves the input data set from the input register to the input buffer.
- Output registers are refreshed when all output registers have been read or when command and set registers bits are set to Automatic. If set to manual, the initiator module moves the output data set from the output buffer to the output register.

When you generate the TLM component with this option, you can use it in a virtual platform (VP) as a standalone component in a test bench, or you can attach it to a communication channel.

Command and Status Register

You can choose to generate a TLM component with an automatically generated memory map with addresses. When you do so, the TLM generator offers you the option to incorporate a Command and Status register (CSR) in the generated TLM component. The definition for this register appears in the table.

Write-Only Bits

Write-only (WO) bits assert mutually exclusive commands. You can assert only one command bit in any single write operation to the CSR. If more than one command bit is set in the write to the CSR, the command is undefined. You activate each command by writing a 1 to a command bit in the register. Then, each command bit is automatically cleared after the command has been executed. You do not have to write a 0 to the register to clear a command bit. Write-Only bits are always returned as 0 in any read of the CSR. Writing a command does not overwrite the Read/Write or Write-Only bits.

Read-and-Write Bits

Use Read and Write (R/W) bits to obtain the current status and setting. R/W bit are *sticky*, meaning that after you set them by writing a 1 to the bit in the register, an R/W bit remains set until a 0 is written to the same bit or the Reset command is invoked. Read-and-Write bits return their actual values to any read of the CSR.

A single write operation to the CSR sets all Read-and-Write bits in the register. You can choose to set only some of the bits and maintain the previous values of others. Before you do so, you must first read the CSR and then modify the values according to your requirements. After you complete modifications, you can write the entire 32 bits back to the CSR.

Read-Only Bits

Read-Only (RO) bits provide status information. The generated TLM component automatically sets and clears their values, and an initiator module can read them to learn status. Read-Only bits do not change their actual values during any read or write of the CSR.

Register Definition

The following table contains the entire register definition.

<7>	<6>	<5>	<4>	<3>	<2>	<1>	<0>
Reserved				Interrupt Disable	Interrupt Status	Start	Reset
				R/W	RO	WO	WO
<15>	<14>	<13>	<12>	<11>	<10>	<9>	<8>
Reserved		Output Auto Mode	Pull Output	Reserved		Input Auto Mode	Push Input
		R/W	WO			R/W	WO
<23>	<22>	<21>	<20>	<19>	<18>	<17>	<16>
Output Buffer Overflow	Output Buffer Underflow	Output Buffer Full	Output Buffer Empty	Input Buffer Overflow	Input Buffer Underflow	Input Buffer Full	Input Buffer Empty
R/W	R/W	RO	RO	R/W	R/W	RO	RO
<31>	<30>	<29>	<28>	<27>	<26>	<25>	<24>
Reserved							

The following table explains how the bits are defined.

Bit	Name	Read/Write Status	Description
CSR<0>	Reset Command	Write Only	<p>When set to 1, the following are true:</p> <ul style="list-style-type: none"> • Input register contents are made invalid • Output register contents are made invalid • All CSR bits are set to 0 except the following: <ul style="list-style-type: none"> • Input Buffer Empty bit is set to 1 • Output Buffer Empty bit is set to 1 • Input Auto Mode is set to default • Output Auto Mode is set to default

Bit	Name	Read/Write Status	Description
			Automatically returns to 0 after command execution.
CSR<1>	Start Command	Write Only	<p>Manually triggers execution of the TLM component behavior using the input data set that is currently in the input register when there is no input buffering.</p> <p>When input buffering is used, this command is undefined.</p>
CSR<2>	Interrupt Status	Read Only	Reflects the current state of the Interrupt signal. Provides status only; sets and clears itself automatically.
CSR<3>	Interrupt Disable	Read and Write	<p>When set to 0 allows interrupts to be generated on the Interrupt signal and reflected in the Interrupt Status bit of the CSR.</p> <p>When set to 1 disables generation of interrupts.</p>
CSR<8>	Push Input Command	Write Only	<p>When buffering is used and the Input Mode is equal to 0 (manual mode), this command allows an initiator module to move the input data set from the input register to the input buffer. It then triggers execution of the TLM component behavior.</p> <p>When buffering is not used, this command is undefined.</p> <p>When Input Mode is 1 (automatic), this command is undefined.</p>

Bit	Name	Read/Write Status	Description
CSR<9>	Input Mode	Read and Write	<p>When set to 1 (automatic), movement of the input data set from the input register to the input buffer and execution of the TLM component behavior is triggered automatically if a complete data set has been written to the input register.</p> <p>When set to 0 (manual): movement of the input data set from the input register to the input buffer and execution of the behavior must be manually initiated. Do so by writing the Start Command bit to 1, if no buffering is used, or writing the Push Input Command to 1, if buffering is present.</p> <p>By default the Input Mode is set to 1 (automatic). The default may be changed to 0 (manual) if you specify it in the TLM component constructor parameters.</p>
CSR<12>	Pull Output Command	Write Only	<p>When buffering is used and the Output Mode is set to 0 (manual mode), this command allows an initiator module to move the output data set from the head of the output buffer to the output register.</p> <p>When buffering is not used, this command has no effect.</p> <p>When Output Mode is 1 (automatic), this command is undefined.</p>

Bit	Name	Read/Write Status	Description
CSR<13>	Output Mode	Read and Write	<p>When set to 1 (automatic), movement of data from the head of the output buffer to the output register is triggered automatically by the execution of the TLM component behavior.</p> <p>When set to 0 (manual), movement of data from the head of the output buffer to the output register must be manually initiated. Do so by writing the Pull Output Command to 1, if buffering is present.</p> <p>By default the Output Mode is set to 1 (automatic). The default may be changed to 0 (manual) if you specify it in the TLM component constructor parameters.</p>
CSR<16>	Input Buffer Empty	Read Only	<p>When set to 1, any TLM component behavior execution without first pushing input data to the input buffer, either automatically or manually, causes the Input Buffer Underflow status to be asserted.</p> <p>This bit is set to 0 by the TLM component when the buffer is not empty.</p>
CSR<17>	Input Buffer Full	Read Only	<p>When set to 1, any push of input data to the input buffer, either automatically or manually, without first executing the TLM component behavior, causes the Input Buffer Overflow status to be asserted.</p> <p>This bit is set to 0 by the TLM component when the buffer is not full.</p>

Bit	Name	Read/Write Status	Description
CSR<18>	Input Buffer Underflow	Read and Write	<p>This bit is set to 1 by the TLM component when an action is taken to initiate execution of the TLM component behavior with no data available in the input buffer.</p> <p>This bit is sticky and can be cleared with a write transaction to set it back to 0.</p>
CSR<19>	Input Buffer Overflow	Read and Write	<p>This bit is set to 1 by the TLM component when input data is pushed to the input buffer, either automatically or manually, and it is already full.</p> <p>This bit is sticky and can be cleared with a write transaction to set it back to 0.</p>
CSR<20>	Output Buffer Empty	Read Only	<p>When set to 1, any pull of output data from the output buffer, either automatically or manually, without first executing the TLM component behavior, causes the Output Buffer Underflow status to be asserted.</p> <p>This bit is set to 0 by the TLM component when the buffer is not empty.</p>
CSR<21>	Output Buffer Full	Read Only	<p>When set to 1, any TLM component behavior execution without first pulling output data to the output registers, either automatically or manually, causes the new output data to be lost and Output Buffer Overflow status to be asserted.</p> <p>This bit is set to 0 by the TLM component when the buffer is full.</p>

Bit	Name	Read/Write Status	Description
CSR<22>	Output Buffer Underflow	Read and Write	<p>This bit is set to 1 by the TLM component when an action is taken to pull data from the output buffer to the output register, either automatically or manually, and there is no data available in the output buffer.</p> <p>This bit is sticky and can be cleared with a write transaction to set it back to 0.</p>
CSR<23>	Output Buffer Overflow	Read and Write	<p>This bit is set to 1 by the TLM component when the TLM component behavior is executed and the output buffer is already full, causing the new output data to be lost.</p> <p>This bit is sticky and can be cleared with a write transaction to set it back to 0.</p>

Interrupt

You can choose to have an interrupt signal added to the generated TLM component. The TLM component will assert this signal whenever new outputs are available in any output register. The signal is automatically cleared whenever a value is read from any output register.

The Interrupt signal is an ordinary SystemC boolean signal active high. The Interrupt Active bit in the Status Register reflects the state of the interrupt signal.

Test and Set Register

HDL Verifier software optionally provides the test and set register as a means of controlling access to a shared TLM component in your SystemC environment. Any read of this register returns the current value and sets the register to a new, asserted value in an atomic operation. In systems where there are multiple initiator modules, executing this task usually requires access to the same target. If so, then an initiator module has

exclusive access to the generated TLM component as long as a common lock protocol is followed by all other initiator modules. The initiator modules must read the test and set register and use the target device only when that read operation returns a value of zero. An initiator module can be sure that any subsequent read of the test and set register returns a value of 1, which indicates to other initiator modules that the device is busy. After gaining exclusive access to the TLM component, an initiator module must release it when the target operations complete by writing a zero to the test and set register.

Tunable Parameter Registers

The tunable parameter registers allows you to make adjustments to the TLM component before or during simulation.

Algorithm Execution

You can choose between having a SystemC thread or a callback function in your generated TLM component.

- SystemC thread: When the input buffers are full or when you write a specific command in the command and status register and event is triggered that the system scheduler picks up. It then executes that function. Results in a likely more realistic simulation but the execution could potentially be slower.
- Callback: When the input buffers are full or when you write a specific command in the command and status register, the function is called directly. Results in faster execution but could be less realistic as the callback method does not process events in the same order they would occur in a real world scenario.

Register and Buffering

- “Introduction” on page 17-18
- “Register” on page 17-19
- “Buffering” on page 17-19

Introduction

The TLM generator allows you to enable or disable input and output data buffering between the TLM component interface and the algorithm processing. For the cases when you have selected temporal decoupling, see “Temporal Decoupling” on page 17-20.

Register

When you disable buffering, the TLM Component reads and writes inputs and outputs directly from the interface register during algorithm processing. Do not allow an initiator to perform a read or write of the registers during algorithm processing; this action could corrupt the processing results. After the initiator writes all input registers (if in AUTO mode) or when the initiator writes the START command in the CSR, the algorithm begins processing. HDL Verifier generates all timings using a SystemC wait function.

The following image demonstrates a TLM component without buffering.

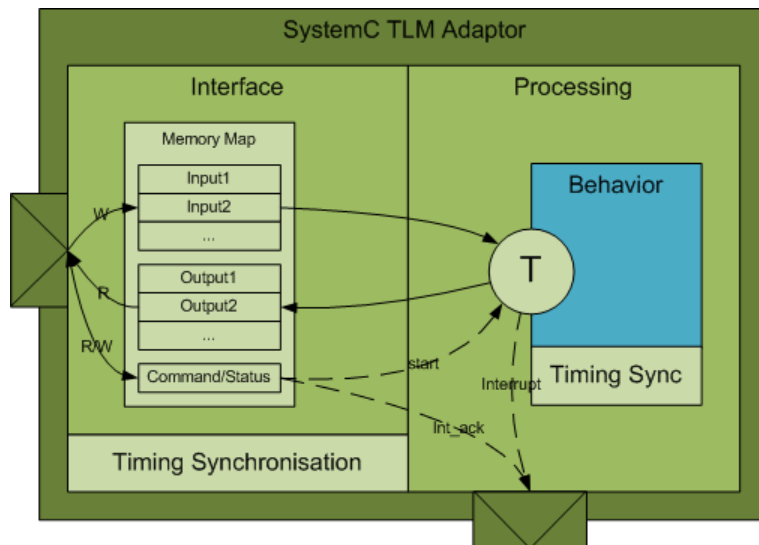

Buffering

When you enable buffering, the TLM component queues the inputs and the outputs in FIFOs between the interface and the algorithm processing. You define the depth of the FIFOs in the TLM generator GUI. The TLM component pushes the content of the input registers in the input queue under either of the following conditions:

- After the initiator writes all input registers (if in AUTO mode)
- When the initiator writes the PUSH command in the CSR

The component triggers algorithm processing as soon as there is data in the queue. When the component completes processing, it pushes the results in the output queue.

The component replaces the content of the output registers with new outputs coming from the output queue (if any are available) under either of the following conditions:

- After the initiator reads all output registers (if in AUTO mode)
- When the initiator writes the PULL command in the CSR

HDL Verifier generates all timings using a SystemC wait function.

The following image demonstrates a TLM component with buffering.

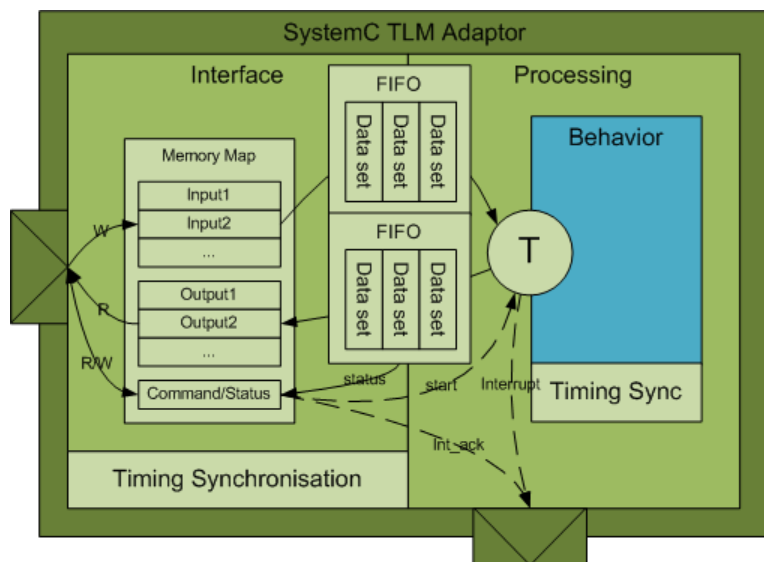

Temporal Decoupling

- “Temporal Decoupling Overview” on page 17-20
- “Temporal Decoupling and No Buffering” on page 17-22
- “Temporal Decoupling and Buffering” on page 17-23

Temporal Decoupling Overview

The TLM generator allows you to enable or disable temporal decoupling between the TLM component interface and the algorithm processing. Temporal decoupling improves

simulation speed by reducing the number of synchronization points and rescheduling that occur during SystemC simulation. With temporal decoupling, the TLM component uses a quantum and allows each process to run ahead of the simulation time inside the boundary of its quantum. This arrangement creates a notion of local time in each thread that represents the thread advance as compared with the simulation time. Because the use of temporal decoupling can change the event order and process execution order, the simulation could lose some accuracy.

The following examples represent a simulation containing three threads:

- An initiator that writes data into the TLM component every 10 ms
- A TLM component that process the data
- A second initiator that reads the results

The time to write, process, or read the data is 5 ms.

In this first diagram, the simulation does not use temporal decoupling.

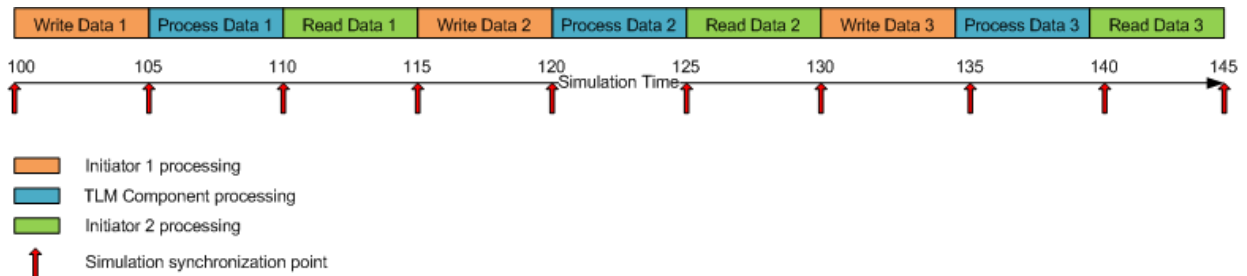

Without temporal decoupling, all the threads execute in sequential order and to exchange the three data the component requires nine context switches.

In this second diagram, the simulation uses temporal decoupling and a quantum of 45 ms.

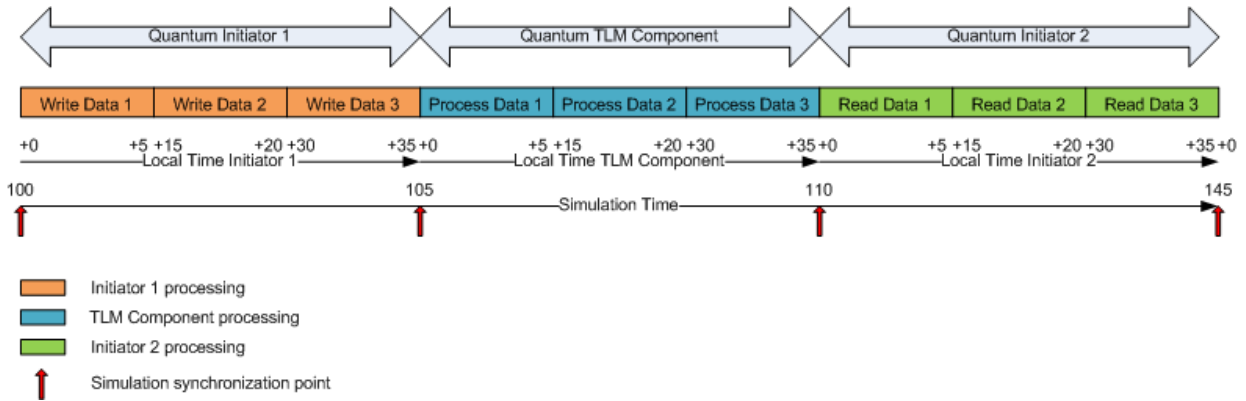

With temporal decoupling, the TLM component modifies the execution order. To exchange the three data, the simulation only requires three context switches. It only requires three context switches because each thread must reach the end of its quantum before giving control back to the simulation. Even with temporal decoupling, the events and data exchanged between each thread happen at the same simulation time as without temporal decoupling. The component does not trigger events immediately but stores them in temporal queues with a timestamp (built using the local time converted into simulation time). When the triggering time is due, the queue triggers the event at the exact simulation time.

For cases when you do not select temporal decoupling, see “Register and Buffering” on page 17-18.

Temporal Decoupling and No Buffering

When you select temporal decoupling and you do not select buffering, the TLM component queues the inputs and the outputs in temporal queues between the interface and the algorithm processing. When a thread writes data in those queues, the queue sorts the data by timestamp. In order to reproduce the behavior of a register that allows data overwriting, when a thread reads the queue, it receives the last written data before its actual local time. The TLM component also queues all events exchanged between the interface and the processing parts of the component in temporal queues. HDL Verifier generates all timings using a timing annotation to the local time.

The following image illustrates a temporal queue:



The following image demonstrates a TLM component using temporal decoupling without buffering.

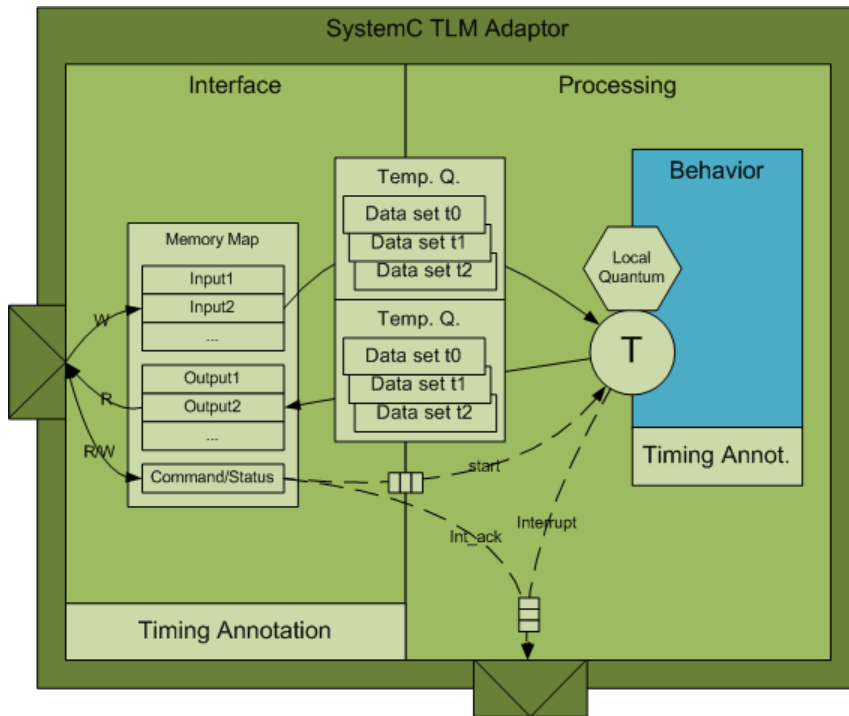

Temporal Decoupling and Buffering

When you select temporal decoupling *and* buffering, the TLM component queues the inputs and outputs in FIFO temporal queues between the interface and the algorithm processing. You define the simulated depth of the FIFOs in the TLM generator GUI. When a thread writes data in those queues, the queue sorts the data by timestamp. In

order to reproduce the behavior of a FIFO that allows queuing of data in the limit of its simulated depth, when a thread reads the queue, it receives the last Nth written data before its actual local time (where N is the FIFO depth) . Imagine the FIFO depth as a sliding window: the data a particular thread is viewing is limited to the simulated depth of the FIFO and its view of the data moves or "slides" forward as local time advances. The following image illustrates a FIFO temporal queue:

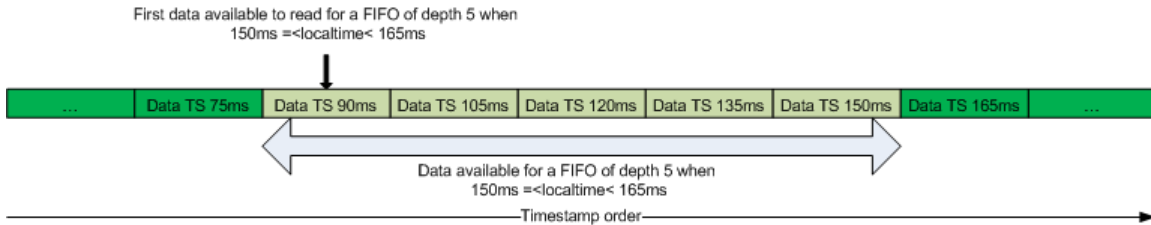

The TLM component also queues all events exchanged between the interface and the processing parts of the TLM component in temporal queues. HDL Verifier generates all timings using a timing annotation to the local time.

The following image demonstrates a TLM component using temporal decoupling and buffering.

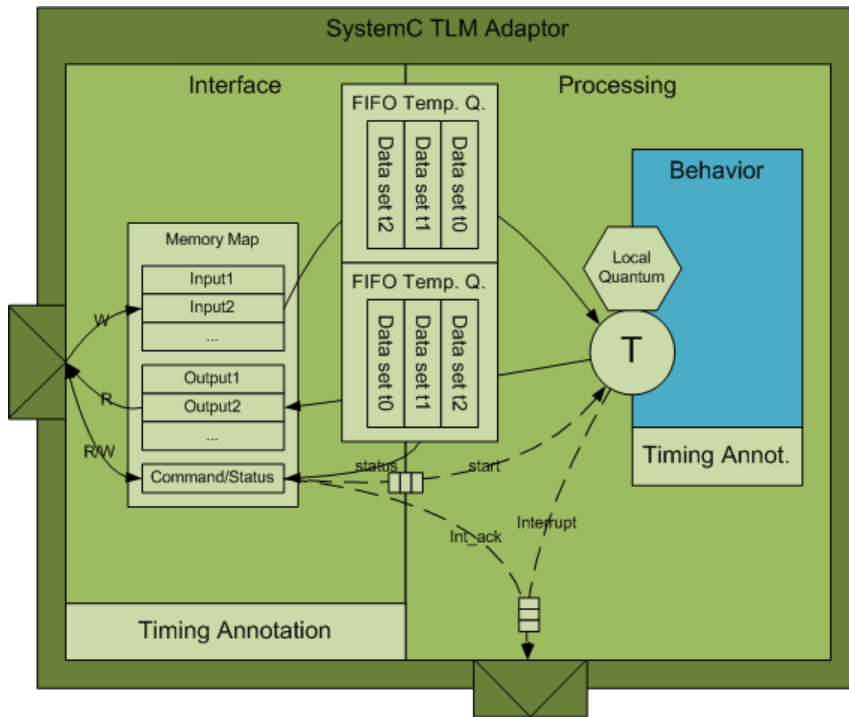

TLM Component Timing Values

You can specify that timing values be stored in the TLM component and supplied to the SystemC environment when the TLM component is used. Those values can be used in a system simulation environment which carries out accounting of execution times in the system, as described in the *OSCI TLM-2.0 Language Reference Manual*. These values—which you supply—represent approximations of the actual time consumed by operations involving the target device in a real system. They also add temporal realism to your system simulations.

At runtime, you can dynamically control the TLM component via a **backdoor** interface to enable and disable the return of timing information. See the generated test bench code for details (locate `mw_backdoorcfg_IF`).

You can represent the following timing values:

- Time consumed by execution of the behavior in the generated TLM component (this delay is simulated by a wait() or a time annotation, depending on the temporal decoupling, in the TLM component thread executing the algorithm step function)
- Time consumed by a write transfer to the TLM component (this delay is returned to the initiator as a wait or time annotation in transaction), with these further qualifiers:
 - Time consumed by a single write transaction or the first write operation of a burst
 - Time consumed by a subsequent write operation in a burst
- Time consumed by a read transfer from the TLM component (this delay is returned to the initiator as a wait or time annotation in transaction), with these further qualifiers :
 - Time consumed by a single read transaction or the first read operation of a burst
 - Time consumed by a subsequent read operation in a burst

HDL Verifier implements the specified timing values as constants in the generated code.

TLM Component Naming and Packaging

An option in the configuration parameters for **TLM Generation** allows you to specify use of a unique tag in naming the generated TLM component. See “Identify Generated Files” on page 21-5 to see how the user tag is applied.

Getting Started with TLM Component Generation

Getting Started with TLM Generator

This example shows how to configure a Simulink® model to generate a SystemC™/TLM component using the `tlmgenerator` target for either Simulink Coder or Embedded Coder™.

For this example, we use a Simulink model of a FIR filter as the basis of the SystemC/TLM generation.

Requirements to run this example:

- MATLAB
- Simulink
- Simulink Coder
- HDL Verifier
- SystemC 2.3.1 (includes the TLM library)
- For code verification, make and a compatible GNU-compiler, `gcc`, in your path on Linux®, or Visual Studio® compiler in your path on Windows®

Note: The example includes a code generation build procedure. Simulink does not permit you to build programs in the MATLAB installation area. If necessary, change to a working directory that is not in the MATLAB installation area prior to starting any build.

1. Open Preconfigured Model

Open the FIR Filter model or, in the MATLAB command window, execute the following:

```
>> openTlmgDemoModel('intro');
```

The following model opens in Simulink.

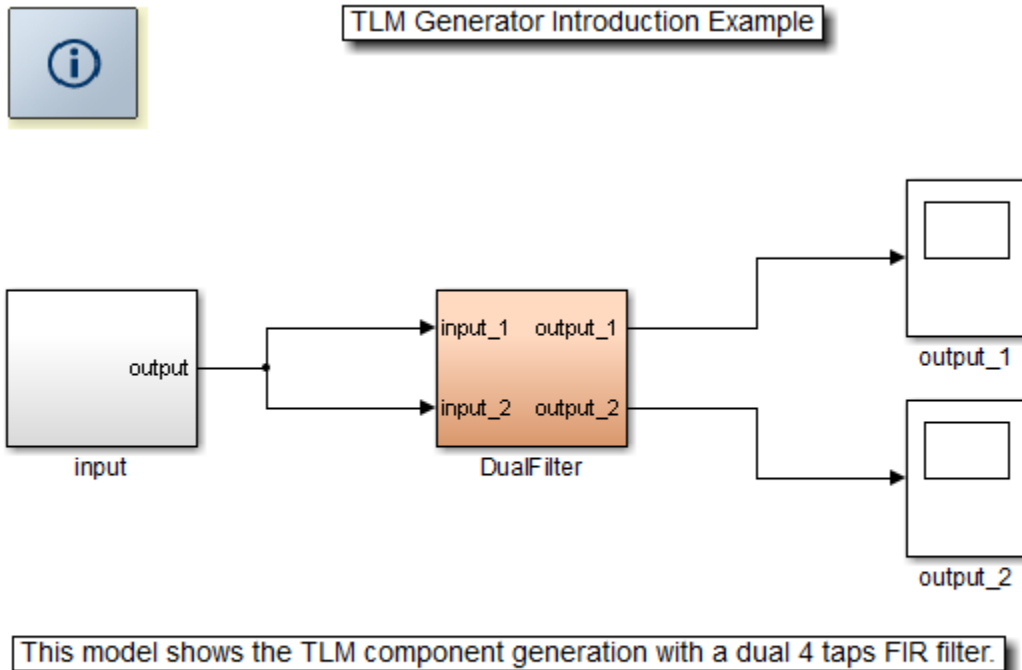

Copyright 1994-2013 The MathWorks, Inc.

2. Set Simulink Coder Target to TLM Generator

a. Open the **Configuration Parameters** dialog box by selecting Simulation > Model Configuration Parameters in the model window.

b. In the **Configuration Parameters** dialog box, select the **Code Generation** view in the left-hand pane.

c. Under **System target file**, click Browse to select the TLM generator target. You can choose `tlmgenerator_grt.tlc` to use Simulink Coder or `tlmgenerator_ert.tlc` to use Embedded Coder for HDL Code generation. For this example, select **`tlmgenerator_grt.tlc`**.

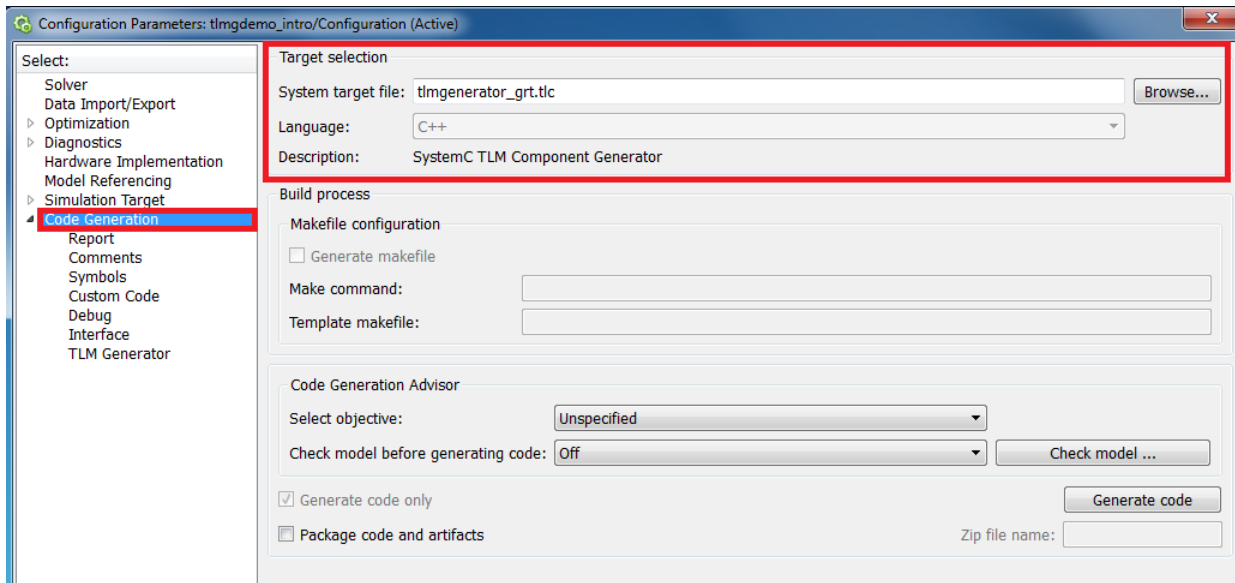

3. Open TLM Generator View

In the **Configuration Parameters** dialog box, select the **TLM Generator** view in the left-hand pane.

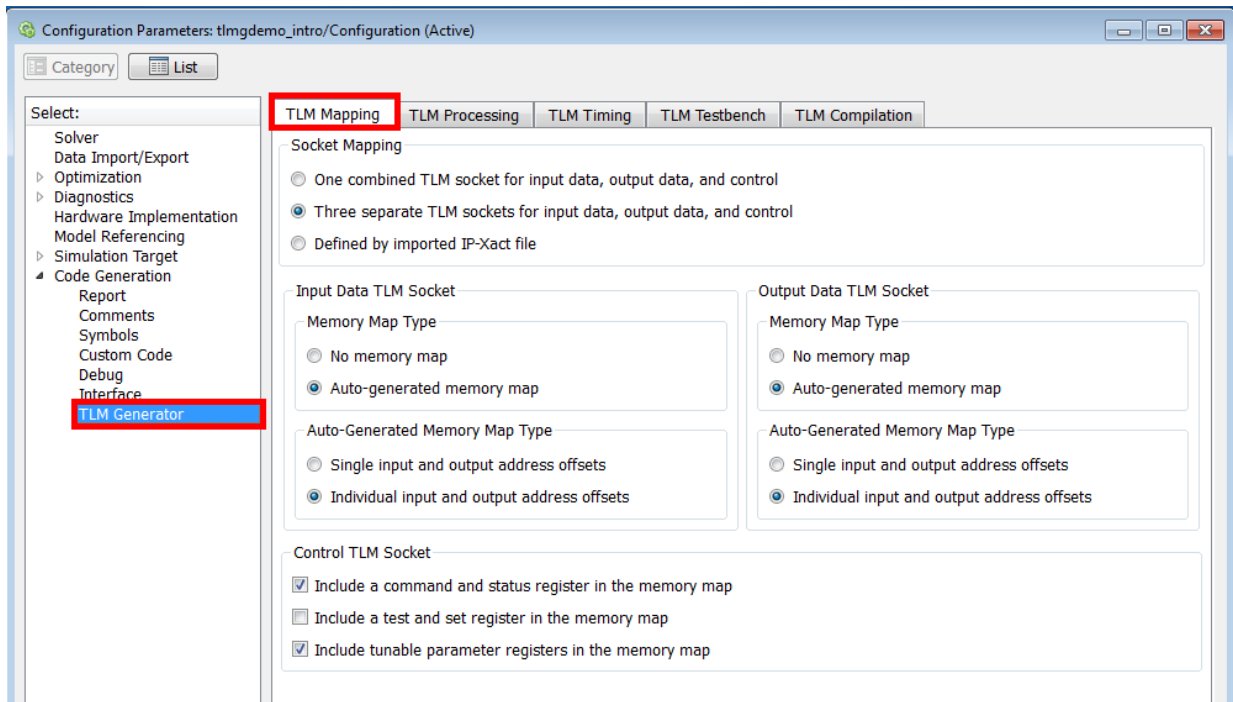

The **TLM Generator** view has five tabs:

- TLM Mapping
- TLM Processing
- TLM Timing
- TLM Testbench
- TLM Compilation

You will need to set different generator options in each pane.

4. Select TLM Mapping Options

In the **TLM Mapping** tab, **Socket Mapping** allows you to select the number of sockets for input data, output data, and control. Select the option, **Three separate TLM sockets for input data, output data, and control**.

Socket Mapping

- One combined TLM socket for input data, output data, and control
- Three separate TLM sockets for input data, output data, and control
- Defined by imported IP-Xact file

The TLM Socket options allow you to define three different memory maps for your generated TLM component.

Input Data TLM Socket

Memory Map Type

- No memory map
- Auto-generated memory map

Auto-Generated Memory Map Type

- Single input and output address offsets
- Individual input and output address offsets

Output Data TLM Socket

Memory Map Type

- No memory map
- Auto-generated memory map

Auto-Generated Memory Map Type

- Single input and output address offsets
- Individual input and output address offsets

Control TLM Socket

- Include a command and status register in the memory map
- Include a test and set register in the memory map
- Include tunable parameter registers in the memory map

For this example, select the following for the input and output data sockets:

- **Auto-generated memory map** for the input and output data sockets
- **Individual input and output address offsets** for each data socket. This option generates a TLM component with one read register per model output and one write register per model input with individual addresses. Each Simulink model input is bound to its corresponding write register and each output is bound to its corresponding read register.

The other memory map options you may consider are:

- **No memory map:** This option generates a TLM component with only one read and one write register without any address. The Simulink model inputs are bound to the write register and the outputs are bound to the read register.
- [Auto-generated memory map with] **Single input and output address offsets:** This option generates a TLM component with only one read and one write register with one address each. The Simulink model inputs are bound to the write register and the outputs are bound to the read register.

When you generate the component with a memory map, you can add a command and status register, a test and set register, and tunable parameter registers.

For this example, select the following for the Control TLM Socket:

- **Include a command and status register in the memory map.** The command and status register allows you to write command and read status during SystemC simulation; for example, manual buffering or buffer status.
- **Include tunable parameter registers in the memory map.** Tunable parameter registers allow you to read or write the tunable parameter values.

Although not used in this example, a test and set register can be used as a mutex when multiple initiators access the component during SystemC simulation.

5. Select TLM Processing Options

In the **TLM Generation** pane, select the **TLM Processing** tab. The **Algorithm Processing** and the **Interface processing** options allow you to define different buffering and processing behaviors for your generated TLM component.

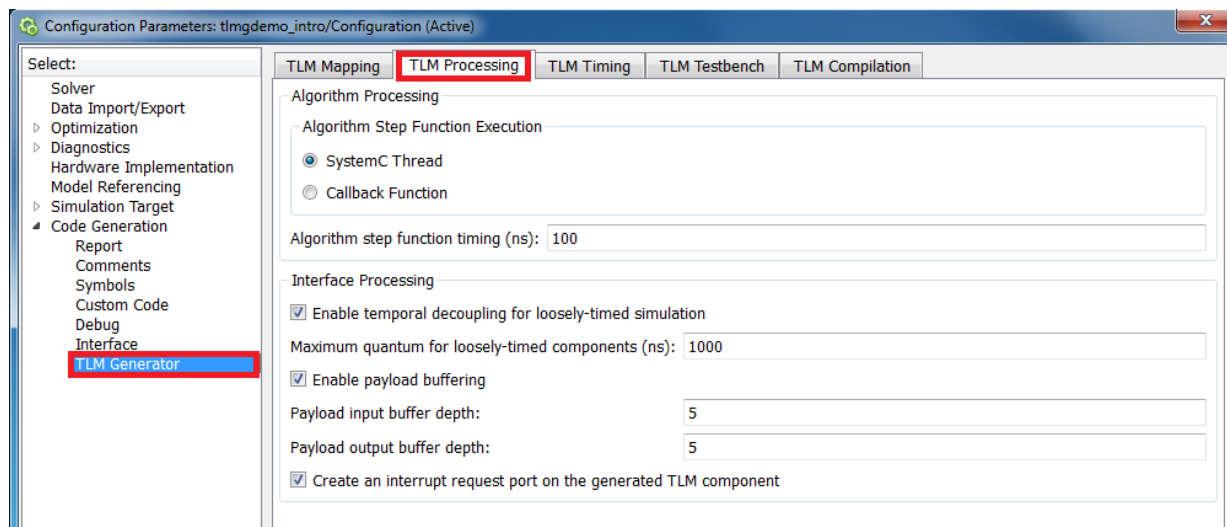

The algorithm execution options are:

- **SystemC Thread:** The step function algorithm is executed in its own independent SystemC thread.
- **Callback Function:** The step function algorithm is executed in a callback function called from the interface.

The step function timing is determined by the value in the **Algorithm step function timing (ns)** field. The algorithm timing is counted with a `wait()` in the thread or, if temporal decoupling is enabled, the algorithm timing is counted with a quantum and time annotation in the thread or callback.

For this example, select **SystemC Thread** and enter 100 in the field for **Algorithm step function timing**.

Interface processing options:

- **Enable temporal decoupling for loosely-timed components (ns):** This option allows time decoupling between the interface and the processing. A quantum and time annotation replace the `wait()` function in the component. The data exchanged between the interface and the processing are stored with timestamp annotation. You must specify the maximum quantum time allowed in the system in the field **Maximum quantum for loosely-timed components (ns)**.

- **Enable payload buffering:** This option adds fifo of definable size between the input/output interface and the processing in the generated component. When you select this option, you must also provide the **Payload input buffer depth** and the **Payload output buffer depth**.
- **Create an interrupt request port on the generated TLM component:** This option creates an interrupt port (type signal, bool>) that is triggered every time a set of input has been processed.

For this example, select or enter the following choices:

- Select **Enable temporal decoupling for loosely-timed components (ns)**, and enter 1000 for **Maximum quantum for loosely-timed components (ns)**.
- Select **Enable payload buffering**, and enter 5 for both the **Payload input buffer depth** and the **Payload output buffer depth**.
- Select **Create an interrupt request port on the generated TLM component**.

6. Select the TLM Timing Options

Select the **TLM Timing** tab. The **Interface Timing** section allows you to define the timing of the component input/output interface and processing thread.

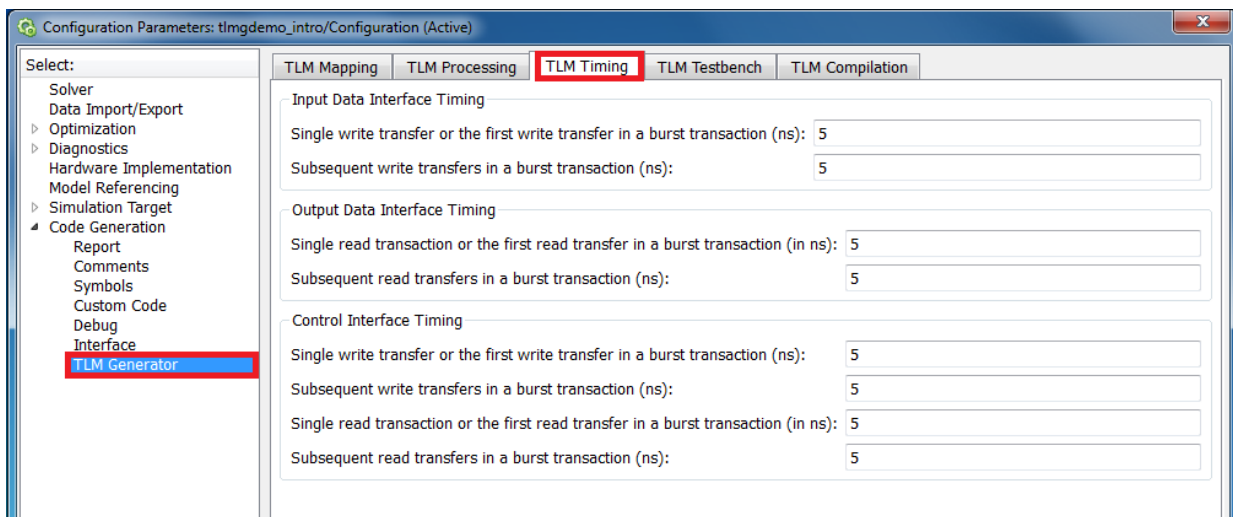

For this example, the input and output delays are counted with `wait()` in the interface or, if the temporal decoupling is enabled, they are annotated to the received transaction and

sent back to the initiator. Set a time value of 5ns for each of the transactions of **Input Data Interface Timing**, **Output Data Interfacing Timing**, and **Control Interface Timing**.

7. Select TLM Testbench View

Select the **TLM Testbench** tab. The TLM Generator target can generate a stand-alone SystemC/TLM test bench alongside the TLM component to verify the generated algorithm in the context of a TLM initiator/target pair. The TLM Testbench view provides run-time options for when the test bench code is generated and executed.

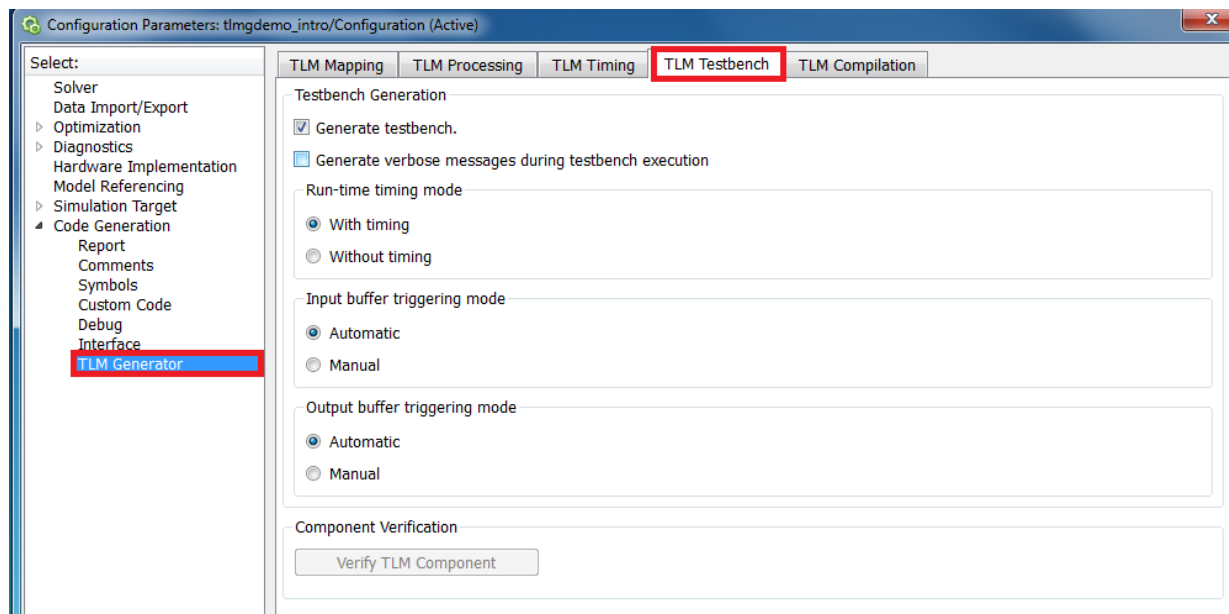

With the TLM Testbench options, you can:

- Choose to see verbose messages echoed to the command window during the SystemC/TLM execution including TLM transaction and synchronization messages.
- Indicate that the test bench should execute with or without timing annotations.
- Indicate whether the initiator controls moving input and output datasets between the registers and the buffers or whether the component performs the moves automatically.

For this example, select **Generate testbench**, **With timing** for **Run-time timing mode**, and **Automatic** for both **Input buffer triggering mode** and **Output buffer triggering mode**.

After code generation has successfully occurred for a component and test bench, the **Verify TLM Component** button becomes enabled. **Verify TLM Component** performs the following:

- Builds the generated code using make and generated makefiles.
- Runs Simulink to capture input stimulus and expected results.
- Converts the Simulink data to TLM vectors.
- Runs the stand-alone SystemC/TLM testbench executable.
- Converts the TLM results back to Simulink data.
- Performs a data comparison.
- Generates a Figure window for any signals that had data mis-compares.

The compilation of the generated files assumes the presence of make and a compatible GNU-compiler, gcc, in your path on Linux®, or Visual Studio® compiler in your path on Windows®.

8. Select TLM Compilation View

Select the **TLM Compilation** tab. This pane provides options to control the generation of makefiles used to compile the generated code.

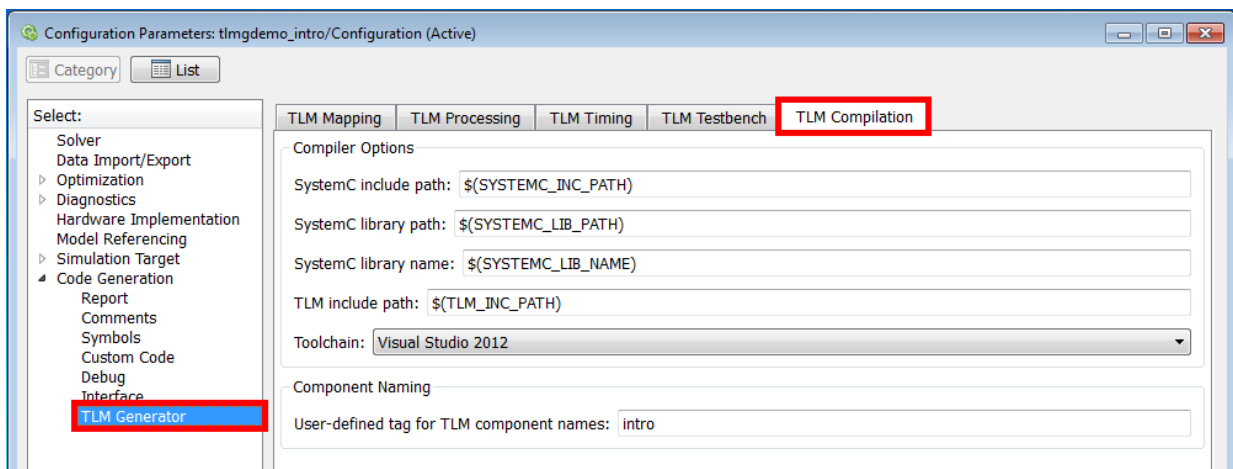

Compiler Options:

The SystemC and TLM include library path options allow you to specify where the makefiles can find the SystemC and TLM installations. The default values allow you to use environment variables so that updates to your SystemC or TLM installations do not require updating your Simulink models. You can set up the environment prior to invoking MATLAB or use the MATLAB `setenv` command.

For this example, these are the environment variable values that were tested with standard OSCI installations located in `/tools`:

- `SYSTEMC_INC_PATH=/tools/systemc-2.3.0/include`
- `SYSTEMC_LIB_PATH=/tools/systemc-2.3.0/lib-linux64`
- `SYSTEMC_LIB_NAME=libsystemc.a (Linux) or systemc.lib (Windows)`
- `TLM_INC_PATH=/tools/systemc-2.3.0/include`

Toolchain:

On Windows this option allows you to select a compiler toolchain when multiple version of Microsoft Visual Studio are installed on the same machine. On Linux this option is fixed on `gcc`.

Component Naming:

This option allows you to add your own tag to the name of the generated component. The generated component name is built according to the following cases:

- If a user tag is specified: `modelname_usertag_tlm`
- If the user tag field is empty: `modelname_tlm`

For this example, enter **intro** for user tag.

9. Select Report

Select **Report** in the left-hand pane. For this example, select **Create code generation report** and **Open report automatically**. These options generate a html report during component generation. The Code generation report details the contents of each generated file.

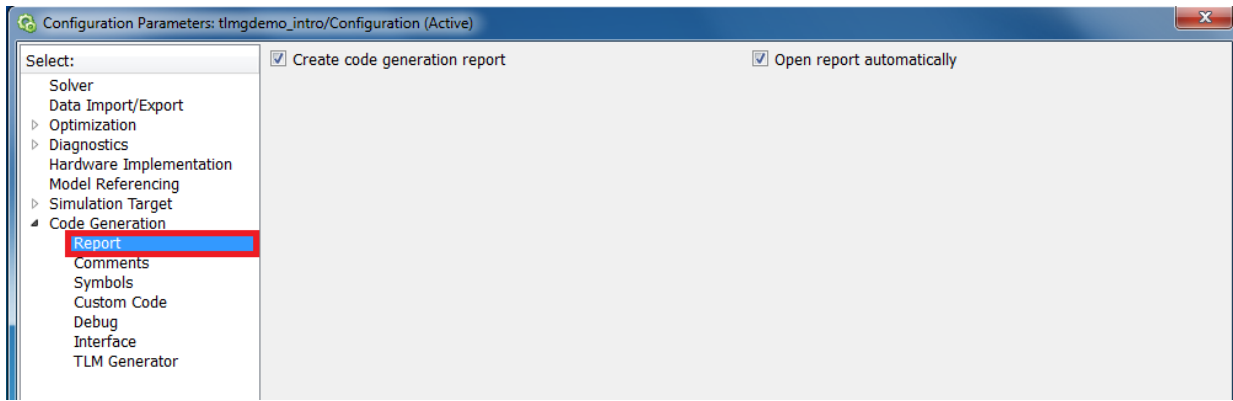

10. Select Debug

Select **Debug** in the left-hand pane. The **Debug** pane allows you to choose the verbose option during component generation. This option could be helpful to track a problem when it occurs during component generation.

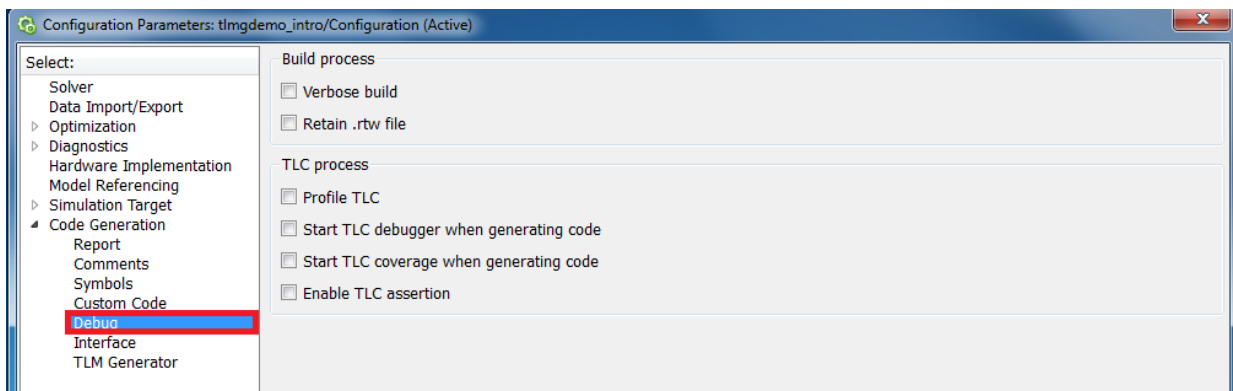

For this example, do not select any of these options.

11. Save TLM Generator Options

Click **OK** to apply these settings and exit the **Configuration Parameters** dialog box.

12. Build Model

In the model window, right-click on the DualFilter block and select **C/C++ Code > Generate Code for this Subsystem** in the context menu to start TLM component generation.

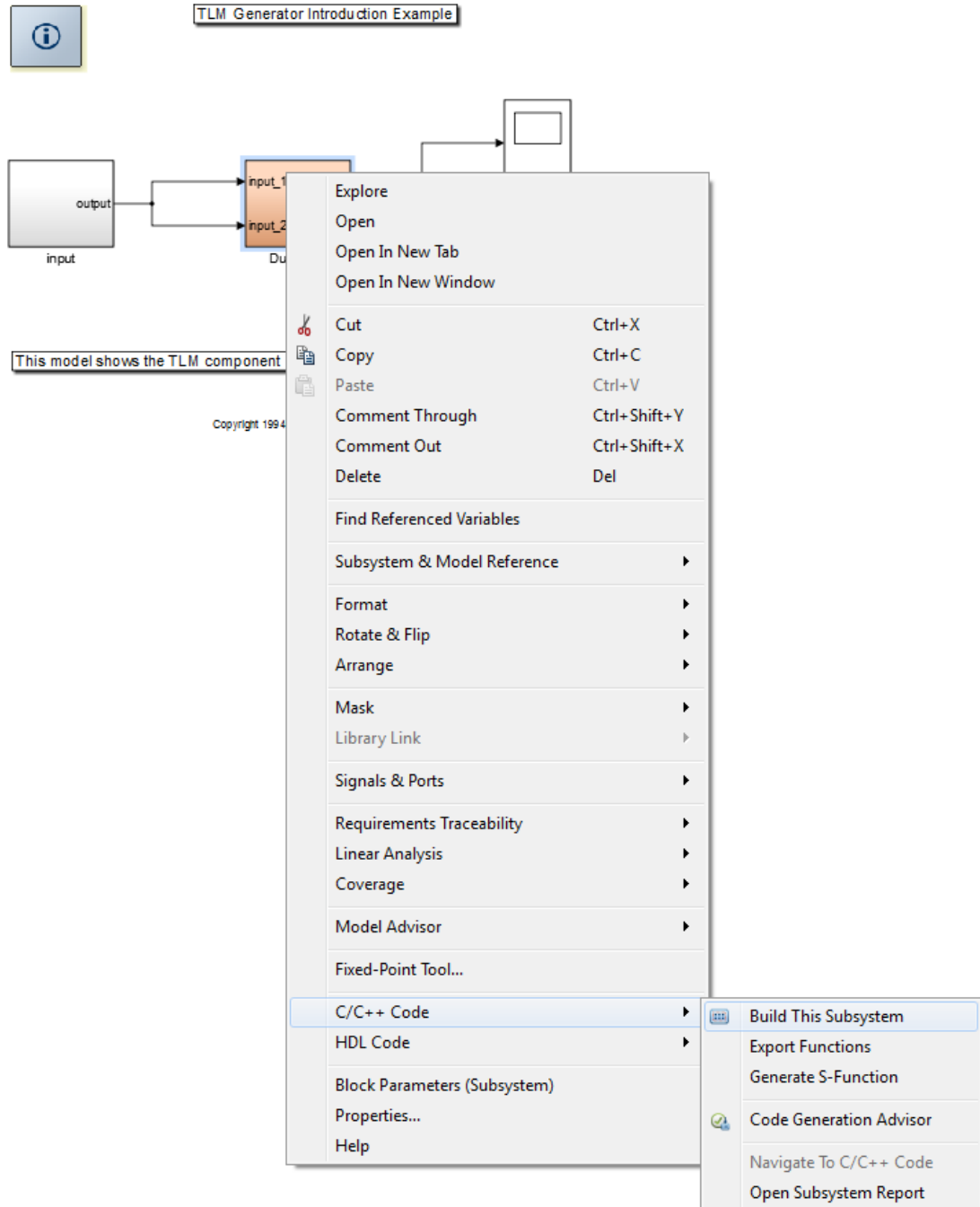

Alternatively, you can execute the following command in the MATLAB command window:

```
>> buildTlmDemoModel('intro');
```

During execution, you will be prompted to select the tunable parameters. The dropdown list of each coefficient allows you to select the storage class of the variable. The Storage Class options are:

- **Inlined** - The inlined parameters are not tunable.
- **SimulinkGlobal** - The SimulinkGlobal variables are tunable.

ExportedGlobal, **ImportedExtern** and **ImportedExternPointer** are not supported by the TLM Generation model.

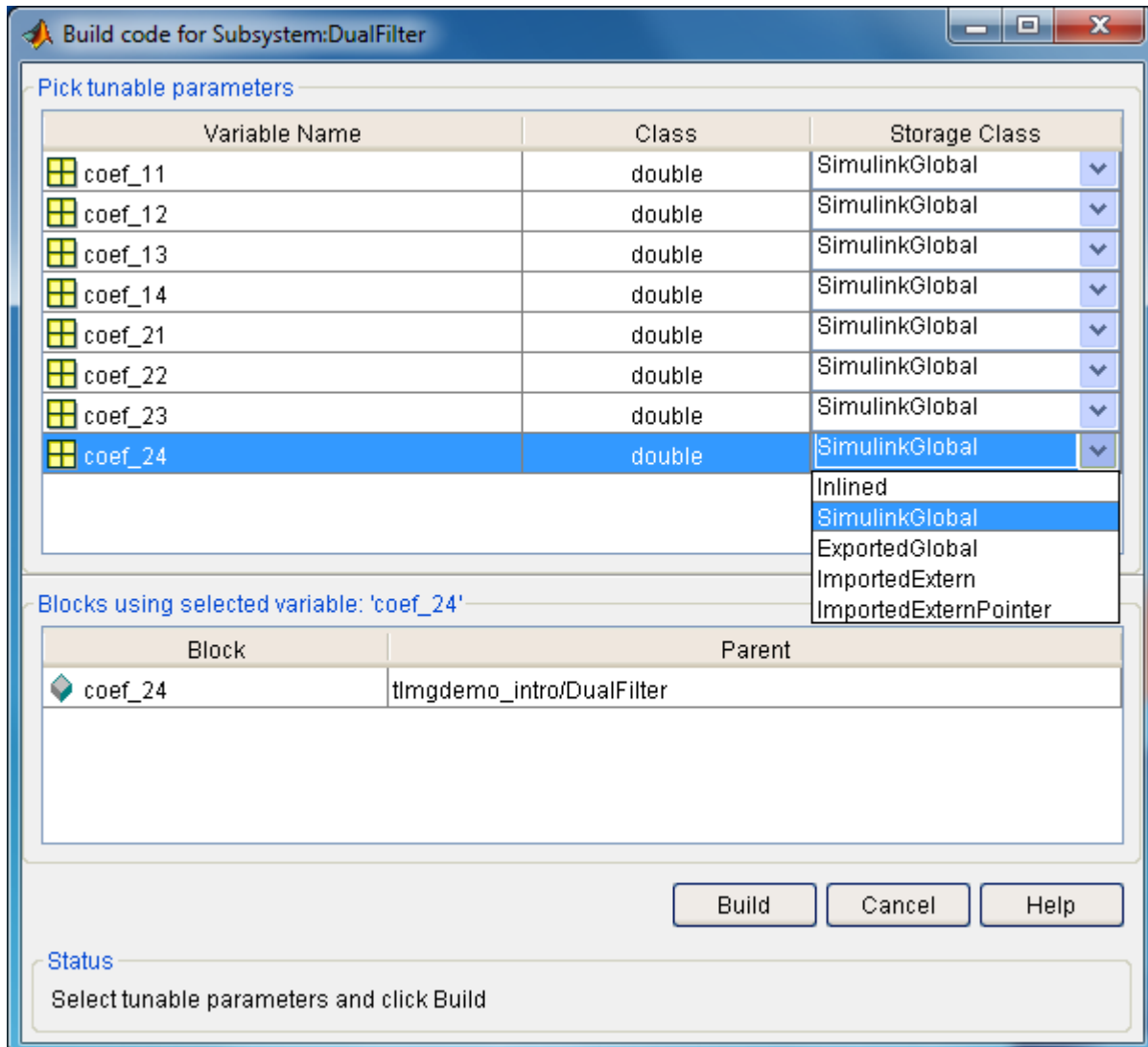

The option **Simulink Global** has been selected for this example. Click **Build**. The TLM generation is completed when you see the following message appear in the MATLAB command window:

```
### Starting Simulink Coder build procedure for model: DualFilter
```

```
### Successful completion of Simulink Coder build procedure for model: DualFilter
```

13. Open Generated Files

Open the generated files in the MATLAB web browser by clicking on the links in the generated report or in the MATLAB Editor (the generated files and report are located in your current working directory):

- DualFilter_VP/DualFilter_intro_tlm_doc/html/DualFilter_codegen_rpt.html
- DualFilter_VP/DualFilter_intro_tlm/DualFilter_intro_tlm.xml
- DualFilter_VP/DualFilter_intro_tlm/include/DualFilter_intro_tlm_def.h
- DualFilter_VP/DualFilter_intro_tlm/include/DualFilter_intro_tlm.h
- DualFilter_VP/DualFilter_intro_tlm/src/DualFilter_intro_tlm.cpp
- DualFilter_VP/DualFilter_intro_tlm_tb/src/DualFilter_intro_tlm_tb.h
- DualFilter_VP/DualFilter_intro_tlm_tb/src/DualFilter_intro_tlm_tb.cpp
- DualFilter_VP/DualFilter_intro_tlm_tb/src/DualFilter_intro_tlm_tb_main.cpp

14. Verify Generated Code

a. Open the **Model Configuration Parameters** dialog box by selecting Simulation > Configuration Parameters in the model window.

b. In the **Configuration Parameters** dialog box, select the **TLM Generator** view, and then select the **TLM Testbench** tab.

c. In the **TLM Testbench** pane, click **Verify TLM Component**, to run the generated testbench.

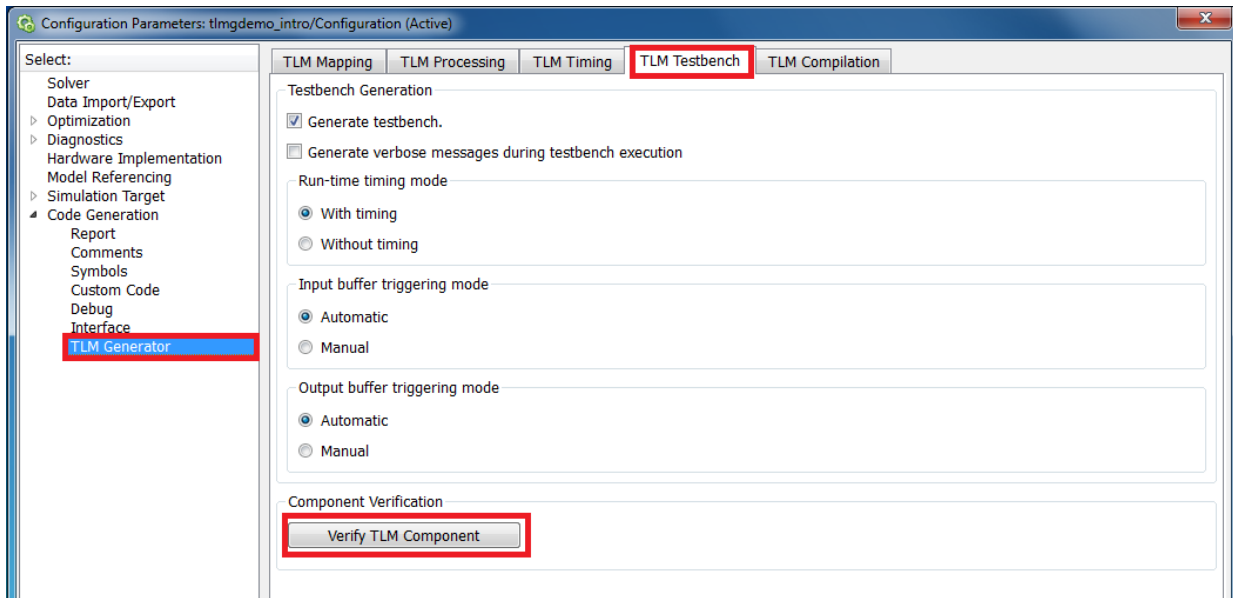

Alternatively, you can execute the following command in the MATLAB command window:

```
>> verifyTlmDemoModel('intro')
```

This verify step performs the following actions:

- Builds the generated code.
- Runs Simulink to capture input stimulus and expected results.
- Converts the Simulink data to TLM vectors.
- Runs the stand-alone SystemC/TLM test bench executable.
- Converts the TLM results back to Simulink data.
- Performs a data comparison.
- Generates a Figure window for any signals that had data mis-compare.

15. Review Execution Log

The option to generate test bench allows you to see how the test bench initiator threads interact and synchronize with the target. Look for the comparison result at the end of the log and verify that there is no data miscompare.

```
### Starting component verification
```

```

### Checking available compiler.
### Building testbench and TLM component.

Microsoft (R) Program Maintenance Utility Version 11.00.50727.1
Copyright (C) Microsoft Corporation. All rights reserved.

nmake.exe /nologo /f makefile.mk all-am OPT_CXXFLAGS="/O2 /MT /D _NDEBUG" OPT_LDFLAGS=
cd ..\DualFilter_intro_tlm && nmake.exe /nologo /f makefile.mk all-am
cd ..\DualFilter && nmake.exe /nologo /f makefile.mk all-am
cl.exe /c /O2 /MT /D _NDEBUG /Fd".\obj\DualFilter.pdb" /D "WIN64" /D "_LIB" /D "_CRT
DualFilter.cpp
cl.exe /c /O2 /MT /D _NDEBUG /Fd".\obj\DualFilter.pdb" /D "WIN64" /D "_LIB" /D "_CRT
DualFilter_data.cpp
lib.exe /nologo /subsystem:console /out:lib\DualFilter.lib obj\DualFilter.obj obj\Dual
-- Build DualFilter.lib completed --

cl.exe /c /O2 /MT /D _NDEBUG /Fd".\obj\DualFilter_intro_tlm.pdb" /D "WIN64" /D "_LIB
DualFilter_intro_tlm.cpp
lib.exe /nologo /subsystem:console /out:lib\DualFilter_intro_tlm.lib obj\DualFilter_in
-- Build DualFilter_intro_tlm.lib completed --

cl.exe /c /O2 /MT /D _NDEBUG /Fd".\obj\DualFilter_intro_tlm_tb.pdb" /D "WIN64" /D "_C
mw_support_tb.cpp
cl.exe /c /O2 /MT /D _NDEBUG /Fd".\obj\DualFilter_intro_tlm_tb.pdb" /D "WIN64" /D "_C
DualFilter_intro_tlm_tb.cpp
cl.exe /c /O2 /MT /D _NDEBUG /Fd".\obj\DualFilter_intro_tlm_tb.pdb" /D "WIN64" /D "_C
DualFilter_intro_tlm_tb_main.cpp
link.exe obj\mw_support_tb.obj obj\DualFilter_intro_tlm_tb.obj obj\DualFilter_intro_t
-- Build DualFilter_intro_tlm_tb.exe completed --

### Running Simulink simulation to capture inputs and expected outputs.
### Executing TLM testbench to generate actual outputs.

SystemC 2.3.1-Accellera --- Jun 18 2014 15:36:00
Copyright (c) 1996-2014 by all Contributors,
ALL RIGHTS RESERVED
[ 0 s] (readerThread) ## found input field tlmg_in1 at tlmg_tlminvec fieldnum 0
[ 0 s] (readerThread) ## found input field tlmg_in2 at tlmg_tlminvec fieldnum 1
[ 0 s] (readerThread) ## found output field tlmg_out1 at tlmg_tlminvec fieldnum 2
[ 0 s] (readerThread) ## found output field tlmg_out2 at tlmg_tlminvec fieldnum 3
[ 0 s] (readerThread) ## setup 2 input data fields, 2 output data fields
## STARTING SIMULATION
[ 0 s] (writerThread) ## Start of vectors from MAT file. Will display '.' for ev
[ 12110 ns] (writerThread) .

```



```
[ 24210 ns] (writerThread) .
[ 36310 ns] (writerThread) .
[ 48410 ns] (writerThread) .
[ 60510 ns] (writerThread) .
[ 60655 ns] (readerThread) ## end of output data...Terminating readerThread
[ 60655 ns] (readerThread)
#####
## END OF VECTORS. PLAYED 501 VECTORS. ##
## DATA MISCOMPARES : 0 ##
## TRANSPORT ERRORS : NO ##
## MAT FILE WRITE ERRORS: NO ##
#####
[ 60655 ns] (readerThread) ## Wrote results MAT file.
[ 61040 ns] (writerThread) ## end of data...Terminating initiator thread.
## SIMULATION HAS ENDED
### Comparing expected vs. actual results.
Data successfully compared for signal tlmg_out1.
Data successfully compared for signal tlmg_out2.
### Component verification completed
```

This concludes the Getting Started with TLM Generator example.

Generate TLM Component

- “TLM Component Generation Workflow” on page 19-2
- “Subsystem Guidelines and Limitations” on page 19-3
- “Select TLM Generator System Target” on page 19-4
- “Select TLM Mapping Options” on page 19-7
- “Select TLM Processing Options” on page 19-11
- “Select TLM Timing Options” on page 19-13
- “Select TLM Testbench Options” on page 19-15
- “Select TLM Compilation Options” on page 19-17
- “Generate Component and Test Bench” on page 19-20
- “Prepare IP-XACT File for Import” on page 19-21
- “Contents of Generated IP-XACT File” on page 19-29
- “Implement Memory Map with SCML” on page 19-33

TLM Component Generation Workflow

The following workflow lists the steps required to generate a TLM component using HDL Verifier software:

- 1** Develop algorithm in Simulink. See “Subsystem Guidelines and Limitations” on page 19-3.
- 2** “Select TLM Generator System Target” on page 19-4
- 3** “Select TLM Mapping Options” on page 19-7
- 4** “Select TLM Processing Options” on page 19-11
- 5** “Select TLM Timing Options” on page 19-13
- 6** “Select TLM Testbench Options” on page 19-15
- 7** “Select TLM Compilation Options” on page 19-17
- 8** “Generate Component and Test Bench” on page 19-20
- 9** (Optional) “Run TLM Component Test Bench” on page 20-7 (verify TLM component)
- 10** “Export TLM Component” on page 21-5

Subsystem Guidelines and Limitations

Most subsystems that can be converted to C code are suitable for generating a TLM component. When you are considering a subsystem for TLM generation, keep in mind the following limitations:

- Simulink subsystem limitations for TLM generation:
 - Same limitations as the Embedded Coder target if you are using Embedded Coder. If you are using Simulink Coder license, then Simulink Coder limitations are the ones that apply.
 - Bus data type not supported
- Simulink subsystem limitations for TLM test bench generation:
 - Composite Simulink signal types not supported (e.g., buses, non-contiguous memory mux block outputs)
 - Multirate subsystems are not supported (however, constants are supported)
 - Complex signals are not supported
 - Subsystems with “action” ports are not supported (e.g., triggered, enabled, if Action, switch case Action)
- SystemC/TLM generated component limitations:
 - TLM simple target socket (with blocking and debug interfaces) using Generic Payload
 - TLM target only (no TLM initiator generation)
 - 32-bit bus width only (address align on 4 bytes)
 - No byte enable
 - No endianness option
 - No streaming
 - No DMI
 - Generic Payload extensions ignored

More About

- “TLM Component Generation Workflow” on page 19-2

Select TLM Generator System Target

Select the system target file to activate TLM Component Generation option tabs.

- 1 Select subsystem. See “Subsystem Guidelines and Limitations” on page 19-3 for help on selecting a suitable subsystem.
- 2 Select **Simulation > Model Configuration Parameters** in Simulink.
- 3 Select **Code Generation**
- 4 Select **Browse** on **System Target File**. Then, follow these guidelines for selecting the correct system target file:
 - With Simulink Coder license, select: `tlmgenerator_grt.tlc`
 - With Embedded Coder license (Simulink Coder license is also required), select: `tlmgenerator_ert.tlc` or `tlmgenerator_grt.tlc`. Target `tlmgenerator_ert.tlc` allows you to access its additional code generation options using the Model Configuration Parameters dialog box.

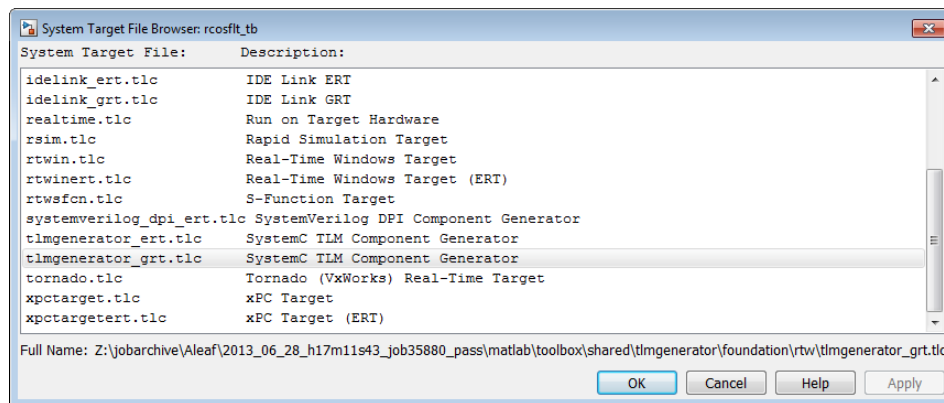

- 5 Click **OK** to see the new **TLM Generator** option under Code Generation.

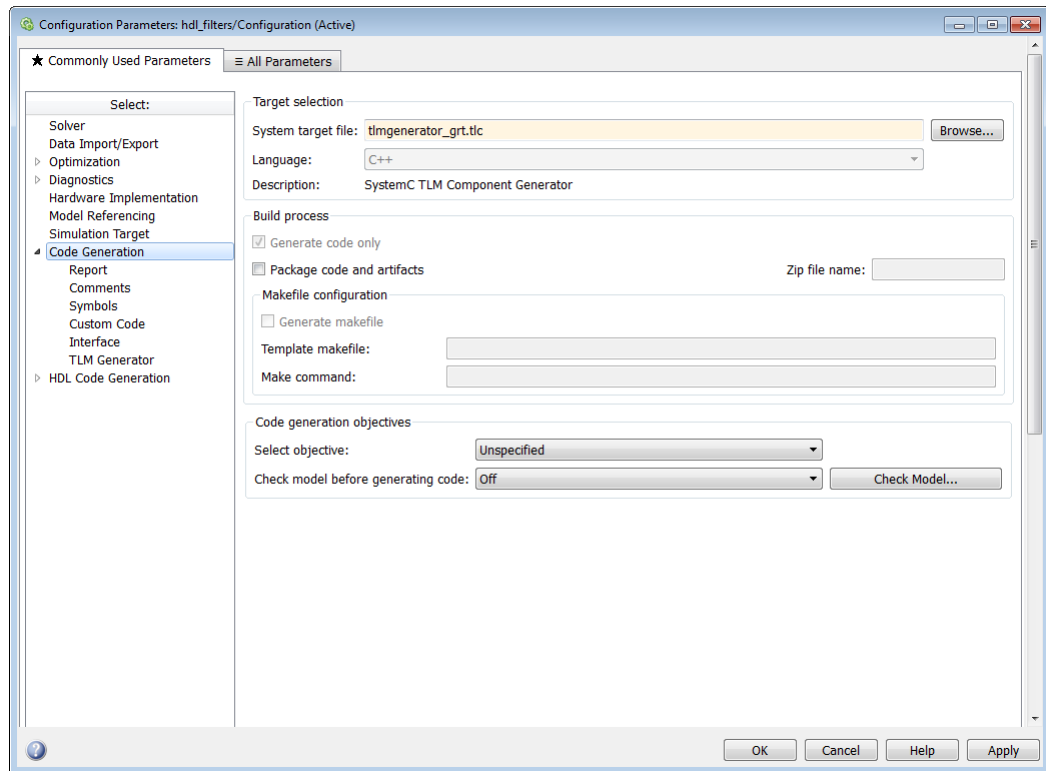

- 6 Click **TLM Generator** to display the TLM Generation options panes.

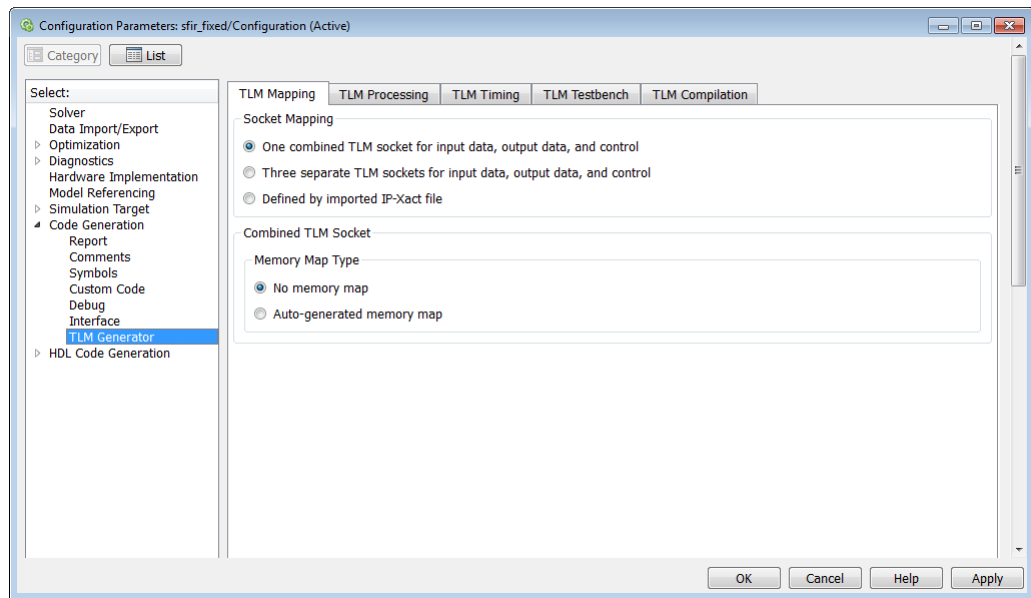

More About

- “TLM Component Generation Workflow” on page 19-2

Select TLM Mapping Options

- 1 Click the **TLM Mapping** tab.
- 2 **Socket Mapping**

Select one of the following:

- **One combined TLM socket for input data, output data, and control**
- **Three separate TLM sockets for input data, output data, and control** (“Single or Multiple Sockets” on page 17-5)
- **Defined by imported IP-XACT file**

When prompted, provide the path and file name of the IP-XACT file.

Import IP-XACT File

IP-XACT file:

Implement memory map with SCML

See “Prepare IP-XACT File for Import” on page 19-21 for IP-XACT file requirements.

When you import an IP-XACT file, you can optionally generate an interface compatible with the System C Modeling Library (SCML). Select **Implement memory map with SCML**. See “Implement Memory Map with SCML” on page 19-33. To use this feature, you must install SCML from Synopsys®.

- 3 For each socket, choose the socket mapping type. For a description of the options available under **Memory Map Type**, see “Memory Mapping” on page 17-5.
 - **No memory map**
 - **Auto-generated memory map**

If you choose **Auto-generated memory map**, the options expand to include the **Auto-Generated Memory Map Type** section, as shown in the following figures:

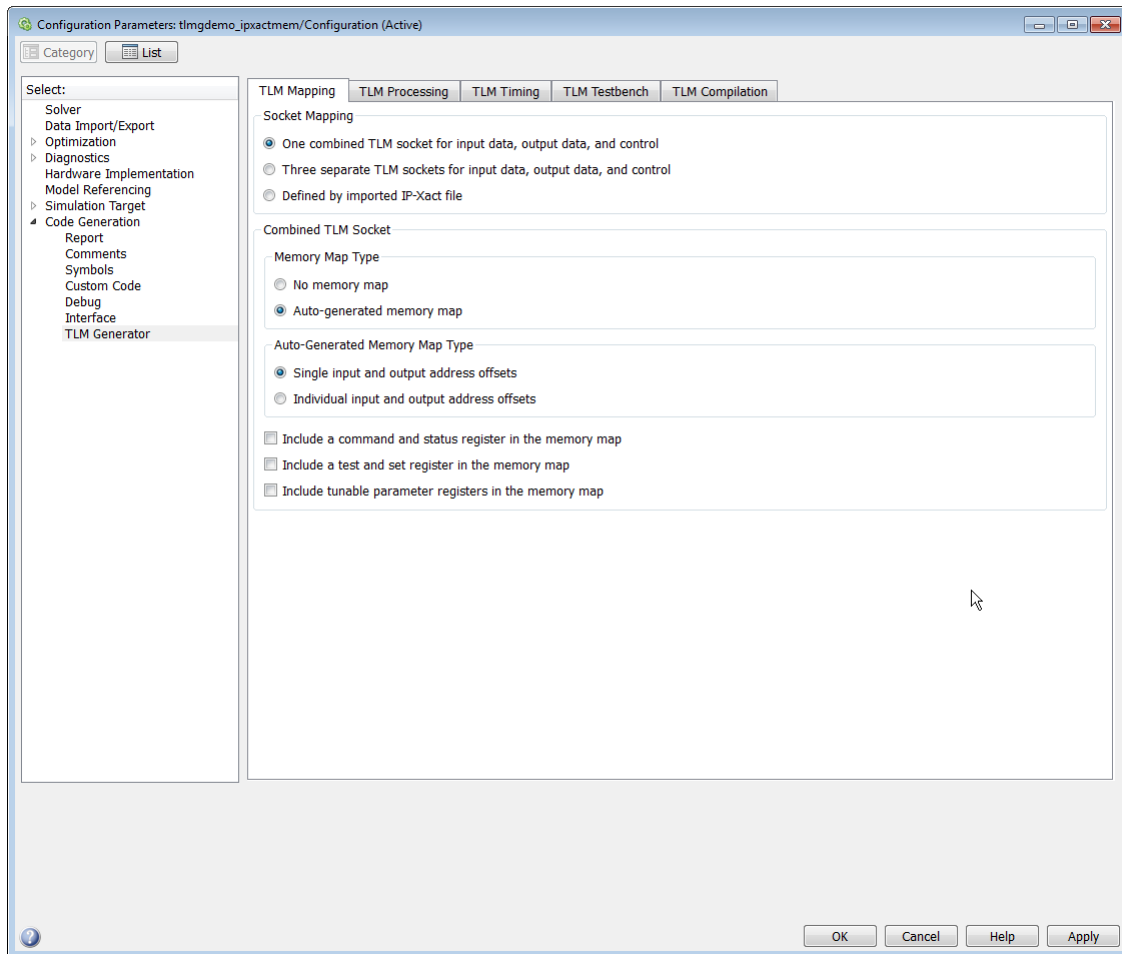

Auto-Generated Memory Map for Single TLM Socket

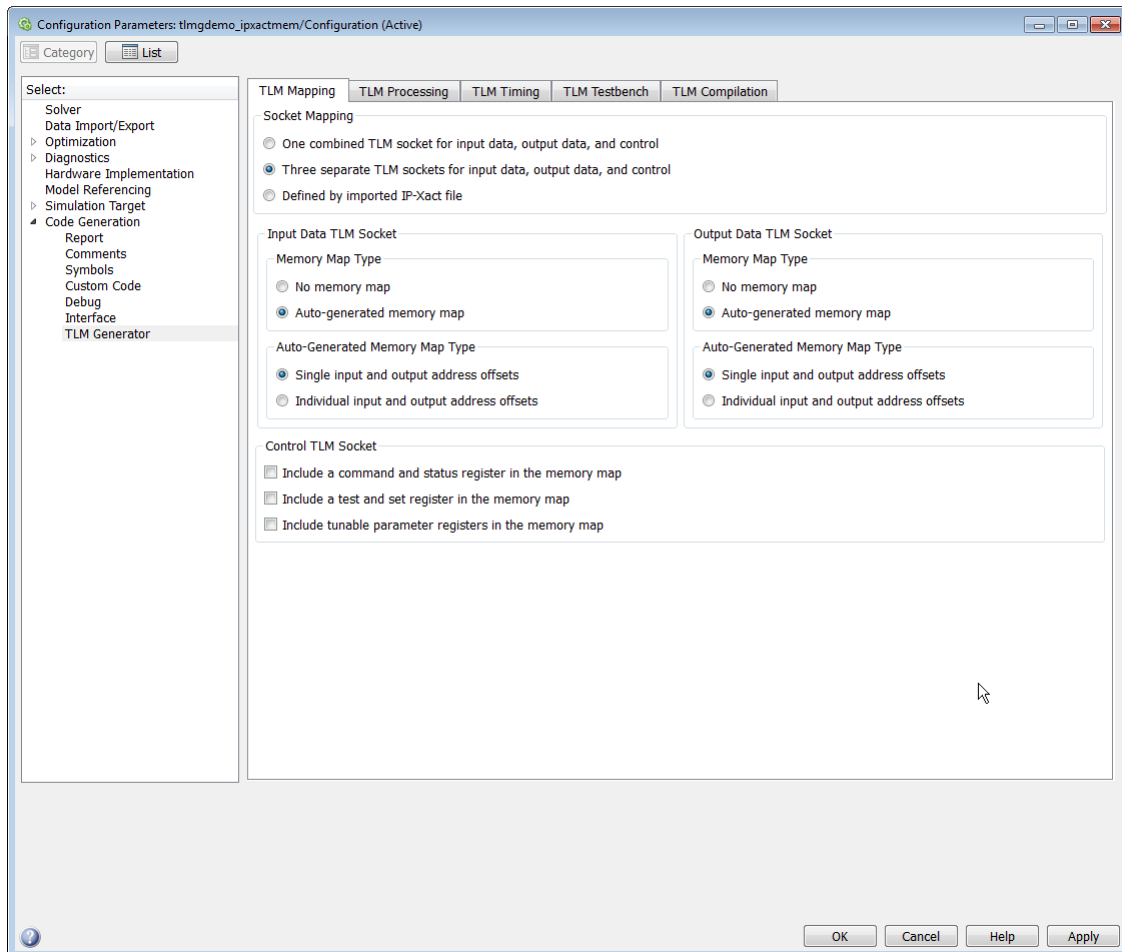

Auto-Generated Memory Map for Separate TLM Sockets

- a Select the autogenerated memory map type for each TLM socket:
 - Single input and output address offsets (“Automatically Generated Memory Map with Single Address” on page 17-6)
 - Individual input and output address offsets (“Automatically Generated Memory Map with Individual Addresses” on page 17-8)

- b** For the control socket (either separate or combined), select any of the following options:
- Include a command and status register in the memory map (see “Register and Buffering” on page 17-18)
 - Include a test and set register in the memory map (“Test and Set Register” on page 17-17)
 - Include tunable parameter registers in the memory map (“Tunable Parameter Registers” on page 17-18).

More About

- “TLM Component Generation Workflow” on page 19-2

Select TLM Processing Options

- 1 Click the **TLM Processing** tab.
- 2 **Algorithm Step Function Execution.** Select one of:
 - **SystemC Thread:** the step function algorithm executes in its own independent SystemC thread.
 - **Callback Function:** the step function algorithm executes in a callback function called from the interface.

Note: When you generate a SCML interface, only **SystemC Thread** is supported.

See “Algorithm Execution” on page 17-18.

- 3 **Algorithm step function timing (ns):** Enter time in nanoseconds.
- 4 **Interface Processing**

Note: **Enable temporal decoupling for loosely-timed simulation** and **Enable payload buffering** will be removed in a future release. Generate your TLM component with the default settings instead. You can manually add a buffer to your SystemC environment if necessary.

- a **Enable temporal decoupling for loosely-timed simulation:** Select to enable temporal decoupling (see “Temporal Decoupling” on page 17-20).

If you select **Enable temporal decoupling for loosely-timed simulation**, enter the **Maximum quantity for loosely-timed components (ns)**.

- b **Enable payload buffering:** Select to enable payload buffering.

If you select **Enable payload buffering**, enter the **Payload input buffer depth** and the **Payload output buffer depth**.

- c **Create an interrupt request port on the generated TLM component:** Select to create interrupt request port.

More About

- “TLM Component Generation Workflow” on page 19-2

Select TLM Timing Options

- 1 Click the **TLM Timing** tab.
- 2 **Combined Interface Timing** (one combined TLM socket for input data, output data, and control)

For all timing options, specify the desired time in nanoseconds.

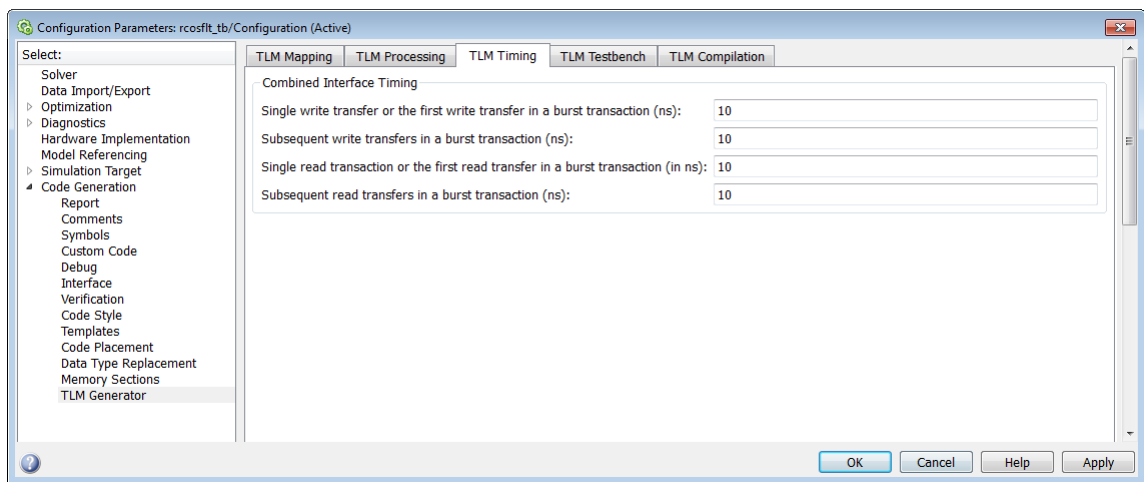

- 3 **Input Data Interface Timing** (separate TLM socket for input data)

For each timing option, specify the desired time in nanoseconds.

- **Single write transfer or the first write transfer in a burst transaction (ns)**
- **Subsequent write transfers in a burst transaction (ns)**

See “TLM Component Timing Values” on page 17-25.

- 4 **Output Data Interface Timing** (separate TLM socket for output data)

For each timing option, specify the desired time in nanoseconds.

- **Single read transaction or the first read transfer in a burst transaction (in ns)**
- **Subsequent read transfers in a burst transaction (ns)**

See “TLM Component Timing Values” on page 17-25.

5 Control Interface Timing (separate TLM socket for control)

For each timing option, specify the desired time in nanoseconds.

- **Single write transfer or the first write transfer in a burst transaction (ns)**
- **Subsequent write transfers in a burst transaction (ns)**
- **Single read transaction or the first read transfer in a burst transaction (in ns)**
- **Subsequent read transfers in a burst transaction (ns)**

See “TLM Component Timing Values” on page 17-25.

More About

- “TLM Component Generation Workflow” on page 19-2

Select TLM Testbench Options

Use the test bench options to specify the following:

- Whether the test bench executes with or without timing annotations (Run-time timing mode)
- Whether the initiator controls moving input and output datasets between the registers and the buffers or if the component moves the datasets automatically.

See “TLM Component Test Bench Generation Options” on page 20-5.

- 1 Click the **TLM Testbench** tab.
- 2 **Generate testbench**: select to generate a test bench for the generated TLM component.
- 3 **Generate verbose messages during testbench execution**: select if you want the test bench to generate verbose messages during test bench execution. See “Verbose Messaging” on page 20-5.
- 4 **Run-time timing mode**
 - **With timing**
 - **Without timing**

See “Run-Time Timing Mode” on page 20-5.

- 5 **Input buffer triggering mode**
 - **Automatic**
 - **Manual**

See “Input Buffer Triggering Mode” on page 20-5.

Note: For this field to be enabled, select **Include a command and status register in the memory map** in the **TLM Generation** tab.

- 6 **Output buffer triggering mode**
 - **Automatic**
 - **Manual**

See “Output Buffer Triggering Mode” on page 20-6.

Note: For this field to be enabled, select **Include a command and status register in the memory map** in the **TLM Generation** tab

7 Component Verification

After code generation is successfully completed, you can use **Verify TLM Component** to perform the following actions:

- Build the generated code using make and generated makefiles.
- Run Simulink to capture input stimulus and expected results.
- Convert the Simulink data to TLM vectors.
- Run the standalone SystemC/TLM test bench executable.
- Convert the TLM results back to Simulink data.
- Perform a data comparison.
- Generate a Figure window for any signals that had data miscompares.

More About

- “TLM Component Generation Workflow” on page 19-2

Select TLM Compilation Options

- 1 Click the **TLM Compilation** tab.

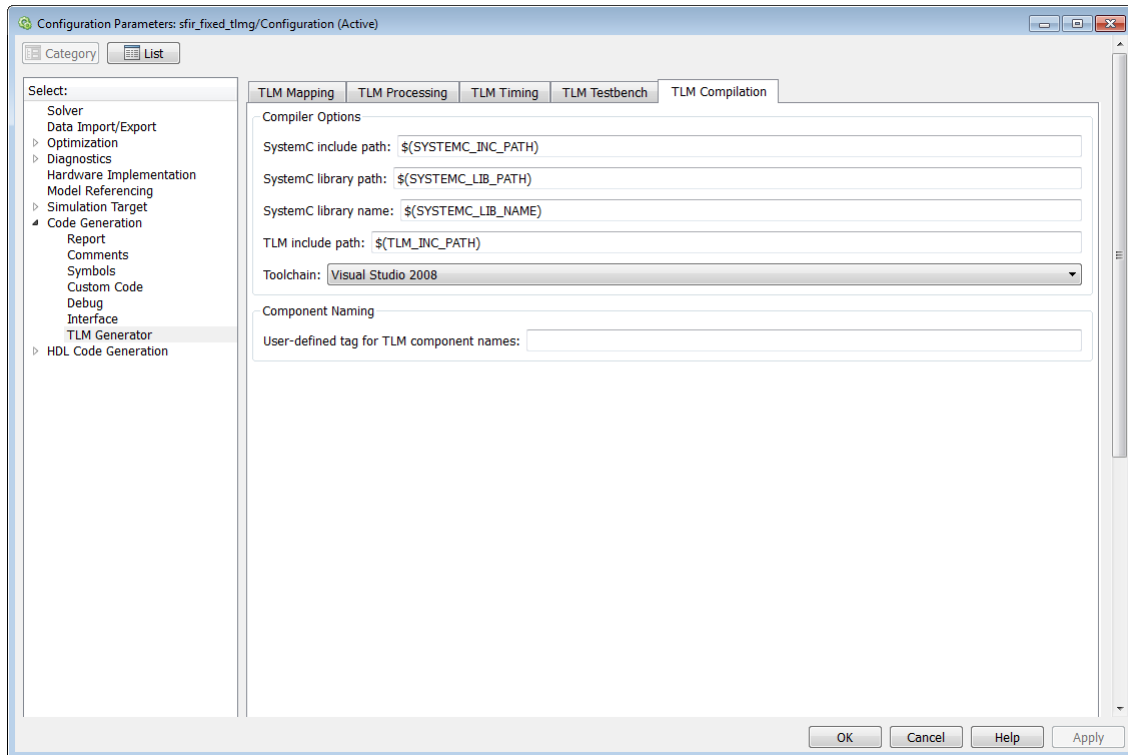

2 Compiler Options

Along with the generated component, the TLM generator also generates a makefile for building the shared libraries. Use the options on the **TLM Compilation** tab to specify certain makefile attributes before you generate code.

- a **SystemC include path**
- b **SystemC library path**
- c **SystemC library name**
- d **TLM include path**

e Toolchain

If you choose **Implement memory map with SCML** on the **TLM Mapping** tab, specify the location of your SCML installation using these additional options.

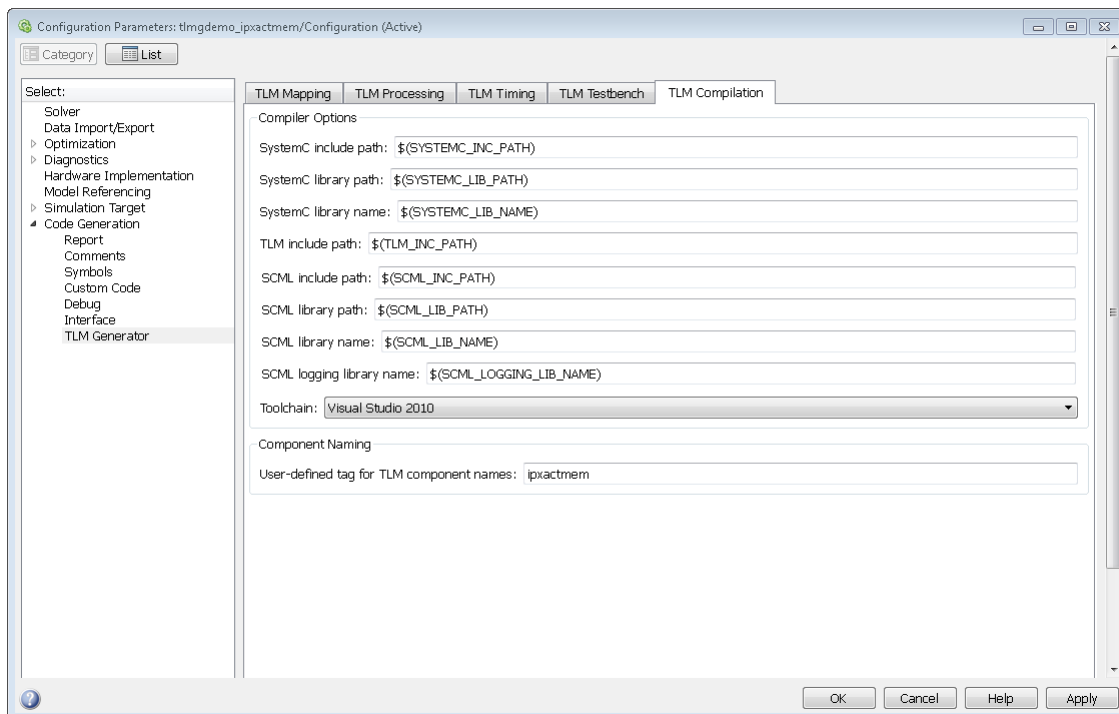

- a SCML include path
- b SCML library path
- c SCML library name
- d SCML logging library name

See “TLM Component Compiler Options” on page 21-2.

3 Component Naming

User-defined tag for TLM component names: Add additional text to your TLM component class name identifier.

See “TLM Component Naming and Packaging” on page 17-26.

More About

- “TLM Component Generation Workflow” on page 19-2

Generate Component and Test Bench

- 1 If you have not yet done so, finish selecting the TLM generation options and click **OK** to save your changes and exit the TLM Generation options panes.
- 2 Generate code. Select one of the following ways:
 - Press **Ctrl-B** (full model).
 - Right-click the subsystem and select **C/C++ Code > Build This Subsystem**.
 - Select **Code > C/C++ Code > Build Model** (this option builds the full model).

Note: Generate the component and test bench on the architecture you plan to use for running the SystemC simulation.

- 3 Go to “Run TLM Component Test Bench” on page 20-7 (optional).

For more about using the generated TLM component, see “Export TLM Component” on page 21-5.

Prepare IP-XACT File for Import

In this section...

“Required Information for Imported IP-XACT Files” on page 19-21

“Bus Interface Definition with No Memory Map” on page 19-22

“Bus Interface Definition with Memory Mapping” on page 19-25

Required Information for Imported IP-XACT Files

All IP-XACT XML files must contain information specific to MathWorks, defined in elements within the component. If this information is not present, the TLM generator cannot parse the IP-XACT file.

The following parameter name-value pairs are required for `<spirit:component>`:

- `<spirit:parameter>`
 - `<spirit:name>MWVendor</spirit:name>`
 - `<spirit:value>MathWorks</spirit:value>``</spirit:parameter>`
- `<spirit:parameter>`
 - `<spirit:name>MWVersion</spirit:name>`
 - `<spirit:value>1.0</spirit:value>``</spirit:parameter>`
- `<spirit:parameter>`
 - `<spirit:name>MWModel</spirit:name>`
 - `<spirit:value>name_of_model</spirit:value>``</spirit:parameter>`
- `<spirit:parameter>`
 - `<spirit:name>MWBlock</spirit:name>`

```

    <spirit:value>name_of_block</spirit:value>
  </spirit:parameter>

```

This image shows these required elements within an IP-XACT XML file.

```

<?xml version="1.0" encoding="UTF-8"?>
<!-- Mathworks -->
- <spirit:component xsi:schemaLocation="http://www.spiri
xmlns:xsi="http://www.w3.org/2001/XMLSchema-inst
  <spirit:vendor>Mathworks.com</spirit:vendor>
  <spirit:name>subsystem_tlm</spirit:name>
  <spirit:version>1.0</spirit:version>
+ <spirit:busInterfaces>
- <spirit:parameters>
  - <spirit:parameter>
    <spirit:name>MWVendor</spirit:name>
    <spirit:value>MathWorks</spirit:value>
  </spirit:parameter>
  - <spirit:parameter>
    <spirit:name>MWVersion</spirit:name>
    <spirit:value>1.0</spirit:value>
  </spirit:parameter>
  - <spirit:parameter>
    <spirit:name>MWModel</spirit:name>
    <spirit:value>tlmgdemo_intro</spirit:value>
  </spirit:parameter>
  - <spirit:parameter>
    <spirit:name>MWBlock</spirit:name>
    <spirit:value>DualFilter</spirit:value>
  </spirit:parameter>
  </spirit:parameters>
</spirit:component>

```

Bus Interface Definition with No Memory Map

- “General Guidelines” on page 19-23

- “Simulink Mapping with No Memory Map” on page 19-23

General Guidelines

Write the bus definitions for your model according to IEEE Standard for IP-XACT 1685-2009.

If you want to use Simulink mapping, all bus interfaces that contain Simulink mapping must be slave interfaces.

Each bus interface with no memory map has one of the following element arrangements for Simulink mapping:

- No mapping to Simulink
- Mapping to Simulink inputs, Simulink outputs, or a mix of inputs and outputs
- Mapping to Simulink tunable parameters

Although each bus interface can have only one arrangement, the IP-XACT file can contain multiple bus interface definitions, each having a different arrangement.

Simulink Mapping with No Memory Map

Each `<spirit:busInterface>` definition containing Simulink mapping is mapped to the TLM target socket. Within the `<spirit:parameters>` tag, add a `<spirit:parameter>` name-value pair that defines the Simulink mapping. For example:

```
<spirit:parameter>  
  <spirit:name>MWMMapInput</spirit:name>  
  <spirit:value>input_1</spirit:value>  
</spirit:parameter>
```

This image shows some bus interfaces that are mapped to Simulink inputs.

```

- <spirit:busInterfaces>
  - <spirit:busInterface>
    <spirit:name>Input</spirit:name>
    <spirit:slave> </spirit:slave>
    - <spirit:parameters>
      - <spirit:parameter>
        <spirit:name>MWMMapInput</spirit:name>
        <spirit:value>input_1</spirit:value>
      </spirit:parameter>
      - <spirit:parameter>
        <spirit:name>MWMMapInput</spirit:name>
        <spirit:value>input_2</spirit:value>
      </spirit:parameter>
    </spirit:parameters>
  </spirit:busInterface>
  - <spirit:busInterface>
    <spirit:name>Output</spirit:name>
    <spirit:slave> </spirit:slave>
    - <spirit:parameters>
      - <spirit:parameter>
        <spirit:name>MWMMapOutput</spirit:name>
        <spirit:value>output_1</spirit:value>
      </spirit:parameter>
      - <spirit:parameter>
        <spirit:name>MWMMapOutput</spirit:name>
        <spirit:value>output_2</spirit:value>
      </spirit:parameter>
    </spirit:parameters>
  </spirit:busInterface>
  - <spirit:busInterface>
    <spirit:name>Param</spirit:name>
    <spirit:slave> </spirit:slave>
    - <spirit:parameters>
      - <spirit:parameter>
        <spirit:name>MWMMapParam</spirit:name>
        <spirit:value>coef_11</spirit:value>
      </spirit:parameter>
      - <spirit:parameter>
        <spirit:name>MWMMapParam</spirit:name>
        <spirit:value>coef_12</spirit:value>
      </spirit:parameter>
    </spirit:parameters>
  </spirit:busInterface>
</spirit:busInterfaces>

```

The inputs are mapped together in one bus interface definition. The outputs are in a separate bus interface. The filter coefficients are in another, separate bus interface.

Alternatively, you can define the inputs and outputs together in a single bus interface definition. However, the filter coefficients must remain in their own separate bus interface definition.

Bus Interface Definition with Memory Mapping

- “General Guidelines” on page 19-25
- “Simulink Mapping Within a Memory Map” on page 19-25

General Guidelines

Write the bus definitions for your model according to IEEE Standard for IP-XACT 1685-2009. The following permissions apply:

- Input registers — Write-only or read-write.
- Output registers — Read-only or read-write.
- Parameters register — Read-only, write-only, or read-write, depending on your requirements.

Make the spirit size of each register, in bits, greater than or equal to the size of that input, output, or parameter in Simulink.

If you want to use Simulink mapping, all bus interfaces that contain Simulink mapping must be slave interfaces.

Simulink Mapping Within a Memory Map

If you have a memory map reference in the bus interface, then you must express the Simulink mapping in the memory map, not in the bus interface.

The Simulink mapping for each register can consist of the following element arrangements:

- No mapping to Simulink (that is, no mapping information is needed in the register)
- Mapping to Simulink inputs, Simulink outputs, or a mix of inputs and outputs
- Mapping to Simulink tunable parameters

Each register can have one of these arrangements, but you cannot mix these options. You also cannot have multiple input-outputs. However, the bus interface can contain multiple registers, each having a different arrangement.

To add inputs, outputs, or parameters to the IP-XACT file:

- 1 Each `<spirit:busInterface>` definition containing Simulink mapping is mapped to the TLM target socket. Add a `<spirit:parameter>` name-value pair that indicates to the TLM generator that there is Simulink mapping in the memory map:

```
<spirit:parameter>
  <spirit:name>MWMMap</spirit:name>
  <spirit:value>true</spirit:value>
</spirit:parameter>
```

- 2 In each `<spirit:memoryMap>` interface, in each `<spirit:register>` definition, within the `<spirit:parameters>` tag, add a `<spirit:parameter>` name-value pair with the Simulink mapping:

```
<spirit:parameter>
  <spirit:name>MWMMapInput</spirit:name>
  <spirit:value>input1</spirit:value>
</spirit:parameter>
```

- 3 To optionally specify field locations within a register, specify a `<spirit:field>` definition in the `<spirit:register>`. Use the `<spirit:bitWidth>` and `<spirit:bitOffset>` tags to define each `<spirit:field>`. Include the `<spirit:parameter>` name-value pair with the Simulink mapping in the `<spirit:field>` definition.

```
<spirit:field>
  <spirit:name>OUTPUT_1</spirit:name>
  <spirit:bitOffset>32</spirit:bitOffset>
  <spirit:bitWidth>32</spirit:bitWidth>
  <spirit:access>read-only</spirit:access>
  <spirit:parameters>
    <spirit:parameter>
      <spirit:name>MWMMapOutput</spirit:name>
      <spirit:value>output_1</spirit:value>
    </spirit:parameter>
  </spirit:parameters>
</spirit:field>
```

This image demonstrates this arrangement for a Simulink input.

```

- <spirit:busInterfaces>
- <spirit:busInterface>
  <spirit:name>InOut</spirit:name>
  - <spirit:slave>
    <spirit:memoryMapRef spirit:memoryMapRef="memorymap_inout"/>
  </spirit:slave>
  - <spirit:parameters>
    - <spirit:parameter>
      <spirit:name>MWMMap</spirit:name>
      <spirit:value>true</spirit:value>
    </spirit:parameter>
  </spirit:parameters>
</spirit:busInterface>
</spirit:busInterfaces>
- <spirit:memoryMaps>
- <spirit:memoryMap>
  <spirit:name>memorymap_inout</spirit:name>
  - <spirit:addressBlock>
    <spirit:name>INPUT_REG</spirit:name>
    <spirit:baseAddress spirit:resolve="user" spirit:id="base_address_input">0x00000000<
    <spirit:range>16</spirit:range>
    <spirit:width>64</spirit:width>
    <spirit:usage>register</spirit:usage>
    - <spirit:register>
      <spirit:name>INPUT_REG_1</spirit:name>
      <spirit:addressOffset>0x0</spirit:addressOffset>
      <spirit:size>64</spirit:size>
      <spirit:access>write-only</spirit:access>
      - <spirit:reset>
        <spirit:value>0x00</spirit:value>
      </spirit:reset>
      - <spirit:parameters>
        - <spirit:parameter>
          <spirit:name>MWMMapInput</spirit:name>
          <spirit:value>input_1</spirit:value>
        </spirit:parameter>
      </spirit:parameters>
    </spirit:register>
    - <spirit:register>
      <spirit:name>INPUT_REG_2</spirit:name>
      <spirit:addressOffset>0x10</spirit:addressOffset>
      <spirit:size>64</spirit:size>
      <spirit:access>write-only</spirit:access>
      - <spirit:reset>
        <spirit:value>0x00</spirit:value>
      </spirit:reset>
      - <spirit:parameters>
        - <spirit:parameter>
          <spirit:name>MWMMapInput</spirit:name>
          <spirit:value>input_2</spirit:value>
        </spirit:parameter>
      </spirit:parameters>
  </spirit:addressBlock>

```

1

2

More About

- “Contents of Generated IP-XACT File” on page 19-29
- IEEE Standard for IP-XACT 1685-2009

Contents of Generated IP-XACT File

In this section...
“Overview of Generated IP-XACT File” on page 19-29
“Generated Simulink Mapping” on page 19-29
“Generated Simulink Mapping in Memory Map” on page 19-30
“Generated Metadata” on page 19-31

Overview of Generated IP-XACT File

The TLM generator automatically generates an IP-XACT file that complies with IEEE Standard for IP-XACT 1685-2009. You can find this file in the same folder as the generated makefile.

The generated IP-XACT file contains the following:

- Mapping information between Simulink and the generated TLM component.
- Metadata specific to MathWorks and the model. This data is intended primarily for reference, but it is required when importing the file for TLM generation.

Generated Simulink Mapping

Each bus interface that uses Simulink mapping without a memory map is defined in the generated file as:

- Inputs
- Outputs
- A combination of inputs and outputs
- Parameters

You can combine inputs and outputs in a single bus interface definition, but you cannot mix parameters and I/O. These elements are defined in a `<spirit:parameter>` name-value pair.

This example from a generated IP-XACT file shows Simulink mapping without a memory map.

```
- <spirit:busInterfaces>
  - <spirit:busInterface>
    <spirit:name>InOut</spirit:name>
    <spirit:slave> </spirit:slave>
    - <spirit:parameters>
      - <spirit:parameter>
        <spirit:name>MWMMapInput</spirit:name>
        <spirit:value>input_1</spirit:value>
      </spirit:parameter>
      - <spirit:parameter>
        <spirit:name>MWMMapInput</spirit:name>
        <spirit:value>input_2</spirit:value>
      </spirit:parameter>
      - <spirit:parameter>
        <spirit:name>MWMMapOutput</spirit:name>
        <spirit:value>output_1</spirit:value>
      </spirit:parameter>
      - <spirit:parameter>
        <spirit:name>MWMMapOutput</spirit:name>
        <spirit:value>output_2</spirit:value>
      </spirit:parameter>
    </spirit:parameters>
  </spirit:busInterface>
</spirit:busInterfaces>
```

Generated Simulink Mapping in Memory Map

In each bus interface with a memory map, the Simulink mapping is expressed in the memory map, not in the bus interface.

The bus interface definition, `<spirit:busInterface>`, contains a `<spirit:parameter>` name-value pair indicating that there is a memory map in use for the interface.

```

- <spirit:parameters>
  - <spirit:parameter>
    <spirit:name>MWMap</spirit:name>
    <spirit:value>true</spirit:value>
  </spirit:parameter>
</spirit:parameters>

```

The memory map interface, <spirit:memoryMap>, contains a <spirit:parameter> name-value pair with the Simulink mapping within each register:

```

- <spirit:register>
  <spirit:name>INPUT_REG_1</spirit:name>
  <spirit:addressOffset>0x0</spirit:addressOffset>
  <spirit:size>64</spirit:size>
  <spirit:access>write-only</spirit:access>
  - <spirit:reset>
    <spirit:value>0x00</spirit:value>
  </spirit:reset>
  - <spirit:parameters>
    - <spirit:parameter>
      <spirit:name>MWMapInput</spirit:name>
      <spirit:value>input_1</spirit:value>
    </spirit:parameter>
  </spirit:parameters>
</spirit:register>

```

The Simulink mapping for each register is defined in the generated file as:

- Input
- Outputs
- A combination of inputs and outputs
- Parameters

You can combine inputs and outputs in a single bus interface definition, but you cannot mix parameters and I/O.

Generated Metadata

Each component definition, <spirit:component>, contains information specific to MathWorks and the model. This information is located within a <spirit:parameter>

element, specified with the `<spirit:name>` and `<spirit:value>` tags. If you plan to import the generated IP-XACT file for use with the TLM generator, these fields are required.

This example shows the metadata in a generated IP-XACT file.

```
- <spirit:component xsi:schemaLocation="http://www.spiritconsortium.org/XMLSchema/SPIRIT/1.5
http://www.spiritconsortium.org/XMLSchema/SPIRIT/1.5/index.xsd" xmlns:xsi="http://www.w3.org/2001/XMLSchema-instance"
xmlns:spirit="http://www.spiritconsortium.org/XMLSchema/SPIRIT/1.5">
.
.
.
- <spirit:parameters>
  - <spirit:parameter>
    <spirit:name>MWVendor</spirit:name>
    <spirit:value>MathWorks</spirit:value>
  </spirit:parameter>
  - <spirit:parameter>
    <spirit:name>MWVersion</spirit:name>
    <spirit:value>1.0</spirit:value>
  </spirit:parameter>
  - <spirit:parameter>
    <spirit:name>MWModel</spirit:name>
    <spirit:value>timgdemo_intro</spirit:value>
  </spirit:parameter>
  - <spirit:parameter>
    <spirit:name>MWBlock</spirit:name>
    <spirit:value>DualFilter</spirit:value>
  </spirit:parameter>
</spirit:parameters>
</spirit:component>
```

Related Examples

- “Prepare IP-XACT File for Import” on page 19-21

More About

- IEEE Standard for IP-XACT 1685-2009

Implement Memory Map with SCML

In this section...

“What Is SCML?” on page 19-33

“Workflow” on page 19-33

“Generated Code” on page 19-33

What Is SCML?

The System C Modeling Library (SCML) is a TLM 2.0 compatible API library for creating TLM model interfaces for use with Synopsys prototyping tools. These tools enable early software integration and testing. The SCML interface provides backdoor register access for the Synopsys tools during simulation. Use HDL Verifier software to export a TLM component with an SCML interface for seamless use with the Synopsys prototyping tools.

Workflow

To generate a TLM component with SCML memory map:

- 1 Install SCML. You can download SCML from Synopsys, see <https://www.synopsys.com/cgi-bin/slcw/kits/reg.cgi>.
- 2 Open **Configuration Parameters>Code Generation>TLM Generator**. See “Select TLM Generator System Target” on page 19-4.
- 3 On the **TLM Mapping** tab, provide an IP-XACT file describing the memory map of your component. Then select the SCML option. See “Select TLM Mapping Options” on page 19-7.
- 4 Specify the location of your SCML installation on the **TLM Compilation** tab. See “Select TLM Compilation Options” on page 19-17.
- 5 Generate code for your model as you would for any other model. See “Generate Component and Test Bench” on page 19-20.

Generated Code

When you generate code for your model, the TLM generator creates the same set of files to implement the TLM component as it would without SCML. The files are named *SystemName_scml* rather than *SystemName_tlm*.

SCML supports bit widths of 8, 16, 32, 64, 128, and 256. When generating the SCML interface for Simulink signals, the generator rounds up to the next supported size.

IP-XACT classes are translated to SCML classes according to this mapping.

IP-XACT Class	SCML Class
spirit::businterface	scml2::t1m2_gp_target_adapter
spirit::addressBlock	scml2::memory
spirit::register	scml2::reg
spirit::field	scml2::bitfield

The SCML interface has no effect on test bench generation for the TLM component. The test bench does not use the SCML access functions.

External Websites

- <https://www.synopsys.com/cgi-bin/slcv/kits/reg.cgi>

Run TLM Component Test Bench

- “Testing TLM Components” on page 20-2
- “TLM Component Test Bench Generation Options” on page 20-5
- “Run TLM Component Test Bench” on page 20-7

Testing TLM Components

In this section...

“TLM Component Test Bench Overview” on page 20-2

“TLM Component Compilation” on page 20-2

“Automatic Verification of the Generated Component” on page 20-3

“Report Generation” on page 20-3

“Working with Configurations” on page 20-3

“Considerations When Creating a TLM Component Test Bench” on page 20-3

TLM Component Test Bench Overview

The test bench generation option is controlled by the **TLM Testbench** tab of the Configuration Parameters dialog box. This option creates a standalone SystemC test bench for the generated component. The test bench works by applying test vectors against the generated TLM component and checking the results of each transaction. When you click the **Verify TLM Component** button on the **TLM Testbench** tab, the test vectors are automatically captured from a Simulink simulation of your model .

You can configure the generated test bench to specify the timing mode and the triggering modes for input and output buffering. The latter choice allows you to indicate whether the initiator module controls moving input and output data sets between the registers and the buffers or whether the component performs the moves automatically. Optionally, the test bench can also produce verbose messages at runtime to help you see the status of the SystemC simulation.

TLM Component Compilation

The **TLM Compilation** tab in the Configuration Parameters dialog box provides SystemC and TLM library location information. You can use environment variables to specify these locations.

The information you provide is used to construct makefile. You can use these makefiles to build the component and test bench. You can also use this makefile to build an executable of the TLM component and test bench outside of the MATLAB environment.

Automatic Verification of the Generated Component

The **TLM Testbench** tab of the configuration parameters provides a **Verify TLM Component** button that:

- Automatically generates input stimulus and expected output data
- Builds and executes the component and the test bench together
- Automatically checks the outputs of the component

It performs the checking by capturing the outputs from the SystemC simulation, converting them to Simulink data, and comparing them in Simulink to the results of the Simulink simulation.

Report Generation

The `tlmgenerator` target supplies an HTML document containing details about the generated component. The document contains links to the generated source code files. Report generation can be configured via the Simulink Coder **Report** pane in the configuration parameters. Report generation is not strictly a test bench feature, but the process does include use of test bench files.

Working with Configurations

After you select configuration options, you can save them with your Simulink model. You can also restore saved configurations made in a previous session. In addition, you can save and choose from multiple configurations for a given model. See the section "Overview of Model Referencing" in the Simulink documentation. for information on working with configurations.

Considerations When Creating a TLM Component Test Bench

For optimizing your generated TLM code and achieving the desired test bench, you should keep the following considerations in mind when developing your Simulink model:

- Your model can use only a single rate.
- The composite signals on your model must be contiguous in memory. You can make mux and bus output signals contiguous with the **Signal Conversion** block.
- If your model contains complex signals, you must split them first. Split complex signals with the Simulink **Complex to Real-Imag** block. You can then combine

the signals again with the Real - Imag to Complex block on the other side of your design.

- Your design can contain a Triggered or Enabled subsystem, but the design you generate cannot itself be a Triggered or Enabled subsystem.
- HDL Verifier can generate a Simulink design that involves continuous time signals. When the Simulink simulation and the captured vector replay in SystemC, they may not yield exactly the same results. The plot of the difference reveals essentially the same curve with numerical differences that are more pronounced at signal transitions, as shown in the following MATLAB Figure windows.

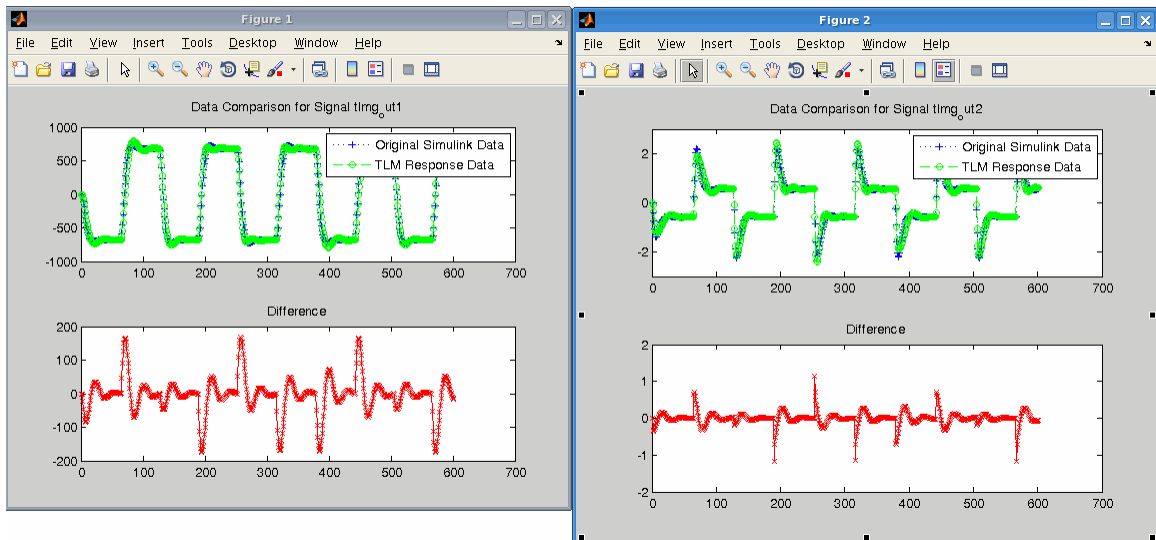

This difference occurs because the Simulink signal capture necessarily makes the signals discrete and thus the same exact data is not used in both the Simulink and stand-alone SystemC simulations. You can improve the fidelity of the discrete signal simulation in SystemC by choosing a smaller fundamental step size in Simulink before clicking **Verify TLM Component**.

TLM Component Test Bench Generation Options

In this section...

“Verbose Messaging” on page 20-5

“Run-Time Timing Mode” on page 20-5

“Input and Output Buffer Triggering Modes” on page 20-5

Verbose Messaging

This option generates verbose messages during test bench execution. The default is not to generate these messages.

Run-Time Timing Mode

This mode allows you to specify which timing mode the generated test bench and TLM component uses. With timing mode selected, the target annotates TLM component transactions with delays, and the initiator module honors them. When a quantum keeper is not used (see “Temporal Decoupling” on page 17-20), the initiator module synchronizes immediately following the transaction execution. When a quantum keeper is used, the initiator module uses temporal decoupling and does not synchronize to the annotated delays until the quantum is reached.

With timing mode not selected, the target does not annotate TLM component transaction with any delays. The initiator module and target only perform synchronization using zero-time wait calls.

Input and Output Buffer Triggering Modes

Input and output buffer triggering modes specify when data is moved from registers to buffers and back. In your TLM environment, these specifications are performed via a runtime configuration command. You can change them dynamically throughout simulation.

Input Buffer Triggering Mode

This option allows you to specify when data moves from the input register to the execution buffer.

The default is automatic mode. In this mode, the TLM component automatically moves input data sets from the input registers to the input buffer. If you instead choose manual mode, the initiator module must explicitly write a command to the command and status register to move the input data set from the register to the input buffer.

Manual mode enables an initiator module to reuse a complete or partial input data set for a subsequent execution of the algorithm, thereby saving simulation time by avoiding data TLM component transactions don't need. For example, if the target uses a full memory map and the initiator module detects that only one of the inputs is changing, the initiator module may execute TLM component transactions only for the changing input. The initiator module then writes a push command to execute the algorithm.

Output Buffer Triggering Mode

Specify when data is moved from the results buffer to the output register.

The default is automatic mode. In this mode, the TLM component automatically moves output data sets from the output buffer to the output registers. If you choose manual mode instead, the initiator module must explicitly write a command to the command and status register to move the output data set from the output buffer to the output registers.

Manual mode enables an initiator module to read only partial output data sets, saving simulation time by avoiding TLM component transactions that are not wanted. For example, if the target uses a full memory map and the initiator module is only interested in the data for one of the outputs, the initiator module can manually move the algorithm results to the register. The initiator module can then execute TLM component transactions only for the output of interest.

Run TLM Component Test Bench

After the TLM component and test bench have been generated, you can verify the generated TLM component using the test bench that was just created:

- 1** Open Model Configuration Parameters. Click on TLM Generation.
- 2** Select the **TLM Testbench** pane.
- 3** Click **Verify TLM Component**. The software performs the following actions:
 - Builds the generated code using make and generated makefiles.
 - Runs Simulink to capture input stimulus and expected results.
 - Converts the Simulink data to TLM vectors.
 - Runs the standalone SystemC/TLM test bench executable.
 - Converts the TLM results back to Simulink data.
 - Performs a data comparison.
 - Generates a Figure window for any signals that had data mismatches.

Note: You must generate the component and test bench before you can select **Verify TLM Component**. See “Generate Component and Test Bench” on page 19-20.

Export TLM Component to SystemC Environment

- “TLM Component Compiler Options” on page 21-2
- “Export TLM Component” on page 21-5
- “TLM Component Constructor and Default Parameters” on page 21-11

TLM Component Compiler Options

In this section...

“About the TLM Component Compiler Options” on page 21-2

“SystemC Installation Variables” on page 21-2

“TLM Include Path” on page 21-3

“Toolchain” on page 21-3

“SCML Installation Variables” on page 21-3

About the TLM Component Compiler Options

The include and library path options for SystemC, TLM, and SCML specify where the makefiles can find the installations. HDL Verifier software writes these strings directly into the generated makefiles.

The default values are environment variables (for example, `$$SYSTEMC_INC_PATH`, `$$SYSTEMC_LIB_PATH`, and `$$TLM_INC_PATH`). If you use the default variable name and define these environment variables in your system, you can usually update your installation without having to update your Simulink models.

SystemC Installation Variables

Include Path

Specify the location of the include folder in your SystemC installation. For example:

```
/systemc-2.2.0/include
```

Alternately, use the default environment variable and define `$$SYSTEMC_INC_PATH` in your system.

Library Path

Specify the location of the library folder in your SystemC installation. For example:

```
/systemc-2.2.0/lib
```

Alternately, use the default environment variable and define `$$SYSTEMC_LIB_PATH` in your system.

Library Name

Specify the name of the SystemC library in your SystemC installation. For example:

- Windows: `systemc.lib`
- Linux: `libsystemc.a`

Alternately, use the default environment variable and define `$SYSTEMC_LIB_NAME` in your system.

TLM Include Path

Specify the location of the include folder in your TLM installation. For example:

```
/tlm-2.0.1/include
```

Alternately, use the default environment variable and define `$TLM_INC_PATH` in your system.

Since SystemC 2.2, the TLM library is included with SystemC. Therefore, this path might be the same as `$SYSTEMC_INC_PATH`.

Toolchain

Specify a compiler from the **Toolchain** drop-down list. The available options are the compiler versions installed on your computer. The default option is the version most recently installed. See “TLM Generation System Requirements” for a list of supported compilers.

SCML Installation Variables

Include Path

Specify the location of the include folder in your SCML installation. For example:

```
/scml-2.2/include
```

Alternately, use the default environment variable and define `$SCML_INC_PATH` in your system.

Library Path

Specify the location of the library folder in your SCML installation. For example:

- Windows: `/scml-2.2/lib/win64`
- Linux: `/scml-2.2/lib/glnxa64`

Alternately, use the default environment variable and define `$SCML_LIB_PATH` in your system.

Library Name

Specify the name of the SCML library in your SCML installation. For example:

```
scml2-vs-11.0.lib
```

Alternately, use the default environment variable and define `$SCML_LIB_NAME` in your system.

Logging Library Name

Specify the name of the SCML logging library in your SCML installation. For example:

```
scml2_logging-vs-11.0.lib
```

Alternately, use the default environment variable and define `$SCML_LOGGING_LIB_NAME` in your system.

Related Examples

- “Select TLM Compilation Options” on page 19-17

Export TLM Component

In this section...

“Identify Generated Files” on page 21-5

“Create Static Library with TLM Component” on page 21-7

“Create Standalone Executable with TLM Component” on page 21-8

Identify Generated Files

After code generation completes, go to your working folder. There you can find the following folder: *model_name_VP/*. This folder contains the files generated for the TLM component. The files appear under the subfolders described in the following table.

Directory Name	Files	Description
<i>model_name</i>	<i>include/model_name*.h</i> <i>src/model_name.cpp</i>	Files relative to the behavior of the model. These files are independent of the TLM options. HDL Verifier provides a makefile for you to build a static library from these source files. If another TLM component is generated from the same model, these files are regenerated (if the model has not changed, the files will be identical). If you generate a second TLM version of the same model with a different tag the TLM files are added to the <i>_VP</i> folder with the new tag. It is possible for the <i>_VP</i> folder to contain multiple TLM variations of the same model all using the same behavior files.
<i>model_name_usertag_tlm</i>	<i>include/model_name_usertag_tlm.h</i> <i>src/model_name_usertag_tlm.cpp</i> <i>include/model_name_usertag_tlm_def.h</i>	These files contain the TLM interface to wrap the core behavior. This file contains addresses and definitions to communicate with the component through the TLM target port using a TLM generic payload.

Directory Name	Files	Description
		<p>The files are sorted in subdirectories by source and header.</p> <p>HDL Verifier provides a makefile for you to build a static library from these source files.</p>
<code>model_name_usertag_tlm_tb</code>	<pre>include/model_name_usertag_tlm_tb.h src/model_name_usertag_tlm_tb.cpp src/model_name_usertag_tlm_tb_main.cpp</pre>	<p>These files contain the core behavior of the test bench.</p> <p>This file instantiates and binds the component and the test bench together.</p> <p>The files are sorted in subdirectories by source and header.</p> <p>HDL Verifier software provides a makefile for you to build an executable from these source file and the component static library. This executable requires the following:</p> <ul style="list-style-type: none"> • Certain MATLAB libraries the executable needs to be built and run. These MATLAB libraries are the static libraries <code>libmat.a</code> and <code>libmx.a</code> and their dynamic counterparts. • The vector <code>.mat</code> files generated when you click the Verify TLM Component button. Before building the component and test bench on the virtual platform, verify that the TLM component includes these files.
<code>model_name_usertag_tlm_doc/</code>	<code>html/model_name_codegen_rpt.html</code>	<p>This file is the entry point of the HTML documentation.</p>

Create Static Library with TLM Component

Create a static library that contains the generated TLM component by following the steps described for Linux or Windows.

Linux Users

- 1 Open a Linux console window.
- 2 Navigate to the *model_name_VP/model_name_usertag_tlm/* folder.
- 3 Execute the following command to start the library compilation:

```
make -f makefile.gnu all
```

If you want to obtain symbols for source code debugging, use the `all-debug` target instead of `all`.

- 4 When the system finishes compiling, locate a library file named `libmodel_name_usertag_tlm.a` in the *model_name_VP/model_name_usertag_tlm/lib/* folder.

Windows Users

If you have not already, make sure that `MATLAB\version\bin\win32` or `MATLAB\version\bin\win64` has been added to your user path.

You can choose one of the following ways to compile your project:

- Compile in Visual Studio® (open the *model_name_usertag_tlm.vcproj* project in Visual Studio and follow the application instructions for compiling your project).
- Compile in a console window.

- 1 Open a system console window.
- 2 Load the compilation tool chain by entering the following at the system prompt:

Win32 users:

```
X:\>"%VS80COMNTOOLS%..\..\VC\vcvarsall" x86
```

Win64 users:

```
X:\>"%VS80COMNTOOLS%..\..\VC\vcvarsall" x64
```

If you have a later version of Visual Studio, you may need to enter "%VS100COMNTOOLS%...", "%VS90COMNTOOLS%..." or "%VS80COMNTOOLS%..." instead. Type `set` at the system prompt for a list of environment variables; in that list you can find the environment variable pointing to where the tool chain is installed.

- 3 In the *same* system console, navigate to the `model_name_VP/model_name_usertag_tlm/` folder.
- 4 Execute the following command to start the library compilation:

```
X:\>nmake /f makefile.mk all
```

If you want to obtain symbols for source code debugging, use the `all-debug` target instead of `all`.

- 5 When the system finishes compiling, locate a library file named `model_name_usertag_tlm.lib` in the `model_name_VP/model_name_usertag_tlm/lib/` folder.

Note: The temporary object files reside in the `model_name_VP/model_name_usertag_tlm/obj/` folder.

Create Standalone Executable with TLM Component

You can create a standalone TLM executable in the command shell by following the steps for Linux or Windows.

Linux Users

- 1 Open a Linux console window.
- 2 Navigate to the `model_name_VP/model_name_usertag_tlm_tb/` folder.
- 3 Execute the following command to start the library compilation:

```
make -f makefile_tb.gnu all
```

If you want to obtain symbols for source code debugging, use the `all-debug` target instead of `all`.

Note: Executing this command also automatically builds a static library with the TLM component source files.

- 4 When the system finishes compiling, locate an executable file named *model_name_usertag_tlm_tb.exe* in the *model_name_VP/model_name_usertag_tlm_tb/* folder.

Windows Users

If you have not already, make sure that `MATLAB\version\bin\win32` or `MATLAB\version\bin\win64` has been added to your user path.

You can choose one of the following ways to compile your project:

- Compile in Visual Studio (open the *model_name_usertag_tlm.vcproj* project in Visual Studio and follow the application instructions for compiling your project).
- Compile in a console window.

- 1 Open a system console window.

- 2 Load the compilation tool chain by entering the following at the system prompt:

Win32 users:

```
X:\>%VS80COMNTOOLS%..\..\VC\vcvarsall" x86
```

Win64 users:

```
X:\>%VS80COMNTOOLS%..\..\VC\vcvarsall" x64
```

If you have a later version of Visual Studio, you may need to enter "`%VS100COMNTOOLS%...`", "`%VS90COMNTOOLS%...`" or "`%VS80COMNTOOLS%...`" instead. Type `set` at the system prompt for a list of environment variables; in that list you can find the environment variable pointing to where the tool chain is installed.

- 3 In the *same* system console, navigate to the *model_name_VP/model_name_usertag_tlm_tb/* folder.

- 4 Execute the following command to start the library compilation:

```
X:\>nmake /f makefile.mk all
```

If you want to obtain symbols for source code debugging, use the `all-debug` target instead of `all`.

Note: Executing this command also automatically builds a static library with the TLM component source files.

- 5 When the system finishes compiling, locate an executable file named `model_name_usertag_tlm_tb.exe` in the `model_name_VP/model_name_usertag_tlm_tb/` folder.

TLM Component Constructor and Default Parameters

The generated TLM component has the following constructor function prototype:

```
model_name_usertag_tlm(sc_core::sc_module_name module_name, ...
    eTimingType DefaultTiming = TIMED,
    eModeType InputDefaultMode = AUTO, eModeType OutputDefaultMode = AUTO);
```

Where:

- `module_name` is a `sc_core::sc_module_name` type. It is a string that contains the instance name.
- `DefaultTiming` is an `eTimingType` {TIMED, UNTIMED}. It determines whether the TLM component is timed or untimed at the beginning of the SystemC simulation. By default, the component initializes `DefaultTiming` to TIMED, but you can change it to UNTIMED. Also during the simulation, you can change the TLM component timing by calling the function `SetTimingParam` (`eTimingType` Type).
- `InputDefaultMode` is an `eModeType` {MANUAL,AUTO}. It determines whether the TLM component input mode is manual or auto at the beginning of the SystemC simulation (and also after SystemC resets the component). By default, the TLM component initializes `InputDefaultMode` to AUTO, but you can change it to MANUAL.
- `OutputDefaultMode` is an `eModeType` {MANUAL,AUTO}. It determines whether the TLM component output mode is manual or auto at the beginning of the SystemC simulation (and also after SystemC resets the component). By default, the TLM component initializes `OutputDefaultMode` to AUTO, but you can change it to MANUAL.

Configuration Parameters for TLM Generator Target

TLM Component Generation

In this section...
“TLM Mapping” on page 22-2
“TLM Processing” on page 22-11
“TLM Timing” on page 22-20
“TLM Testbench” on page 22-24
“TLM Compilation” on page 22-29

TLM Mapping

TLM Generator Overview

The following user interface tabs contain the parameters for setting options on the generated TLM component:

- **TLM Mapping:** Specify options for socket and memory mapping. See “Select TLM Mapping Options” on page 19-7.
- **TLM Processing:** Specify options for algorithm and interface processing. See “Select TLM Processing Options” on page 19-11.
- **TLM Timing:** Specify options for combined interface timing, or for individual timing for input data, output data, and control sockets. See “Select TLM Timing Options” on page 19-13.
- **TLM Testbench:** Specify options for the generation and runtime behavior of a standalone SystemC/TLM component test bench. See “Select TLM Testbench Options” on page 19-15.
- **TLM Compilation:** Specify generated TLM component compilation options. See “Select TLM Compilation Options” on page 19-17.

Socket Mapping

Choose the type of TLM socket for input data, output data, and control.

Settings

Default: One combined TLM socket for input data, output data, and control

- **One combined TLM socket for input data, output data, and control:** Create one combined TLM socket in the generated TLM component.
- **Three separate TLM socket for input data, output data, and control:** Create three separate TLM sockets. Generate each data socket with the following options:
 - Auto-generated memory map (or without memory map)
 - Command and status registers
 - Test and set registers
 - Tunable parameter registers
- **Defined by imported IP-XACT file:** Define the memory map for the TLM component according to instructions in an IP-XACT file. When you select this option, you must specify the IP-XACT file to use. See “Prepare IP-XACT File for Import” on page 19-21.

Dependencies

This parameter enables **Combined TLM Socket** or **TLM Socket for Input Data, TLM Socket for Output Data**, and **TLM Socket for Control with Memory Map**.

Setting this parameter to **One combined TLM socket for input data, output data, and control** opens the **Combined TLM Socket** options selection.

Setting this parameter to **Three separate TLM socket for input data, output data, and control** opens the **TLM Socket for Input Data, TLM Socket for Output Data**, and **TLM Socket for Control with Memory Map** options selection.

Setting this parameter to **Defined by imported IP-XACT file** opens the **Import IP-XACT File** options selection.

Command-Line Information

Parameter: tlmComponentSocketMapping

Type: string

Value: |

Default:

Memory Map Type

Choose the type of addressing scheme for the combined TLM socket or the separate TLM input data and output data sockets.

Settings

Default: No memory map

- **No memory map:** Create a single input register and a single output register in the generated TLM component
- **Auto-generate memory map:** Create a single input address and a single output address for all inputs and outputs or create a separate input register for every input signal and a separate output register for every output signal

Dependencies

This parameter enables **Auto-Generated memory map Type**.

Setting this parameter to **Auto-generate memory map** opens the **Auto-Generated Memory Map Type** options selection.

Command-Line Information

Parameter: tlmComponentAddressing (for combined TLM socket) |
tlmgComponentAddressingInput | tlmComponentAddressingOutput

Type: string

Value: 'No memory map' | 'Auto-generated memory map'

Default: 'No memory map'

See Also

“Memory Mapping” on page 17-5

Auto-Generated Memory Map Type

Choose the type of addressing scheme to be automatically generated.

Settings

Default: Single input and output address offsets

- **Single input and output address offsets:** Create a single address offset for the inputs and a single address offset for the outputs
- **Individual input and output address offsets:** Generate an address for each input and each output

Dependencies

Auto-Generated memory map enables this parameter.

Command-Line Information

Parameter: `tlmgAutoAddressSpecType` (for combined TLM socket) |
`tlmgAutoAddressSpecTypeInput` | `tlmgAutoAddressSpecTypeOutput`

Type: `string`

Value: `'Single input and output address offsets'` | `'Individual input and output address offsets'`

Default: `'Single input and output address offsets'`

See Also

“Memory Mapping” on page 17-5

Import IP-XACT File

Define the memory map of the TLM component from an imported file.

Settings

Default: No file specified, no SCML implementation

- **IP-XACT file:** Specify a file that defines the memory map for the TLM component, in IP-XACT format.
- **Implement memory map with SCML:** Generate an interface compatible with the System C Modeling Library (SCML). See “Implement Memory Map with SCML” on page 19-33.

Dependencies

When you select **Implement memory map with SCML**, also set path variables for the SCML libraries on the **TLM Compilation** tab. When you select **Implement memory map with SCML**, the **Algorithm Step Function Execution** option on the **TLM Processing** tab is set to **SystemC Thread**.

Command-Line Information

Parameter: tlmgIPXACTPath

Type: string

Value:

Default:

Parameter: tlmgSCMLOnOff

Type: string

Value: 'on' | 'off'

Default: 'off'

See Also

“Memory Mapping” on page 17-5

Include a command and status register in the memory map

Allows an initiator to send the TLM component commands such as "reset" and "start", as well as read status bits such as "interrupt active", "output buffer overflowed", and "input buffer empty".

Settings

Default: On

On

Include a command and status register in the memory map

Off

Do not include a command and status register in the memory map

Dependencies

If you selected a combined TLM socket, **Auto-Generated Memory Map** enables this parameter.

If you selected Separate TLM sockets, this parameter is automatically enabled for the control TLM socket.

Command-Line Information

Parameter: `tmgCommandStatusRegOnOff`

Type: string

Value: 'on' | 'off'

Default: 'on'

See Also

“Command and Status Register” on page 17-10

Include a test and set register in the memory map

Provides a means of controlling access to a shared TLM target device in your SystemC environment.

Settings

Default: Off

On

Include a test and set register in the memory map. Any read of this register will return the current value and set the register to a new, asserted value in an atomic operation.

Off

Do not include a test and set register in the memory map

Dependencies

If you selected a combined TLM socket, **Auto-Generated Memory Map** enables this parameter.

If you selected separate TLM sockets, this parameter is automatically enabled for the control TLM socket.

Command-Line Information

Parameter: `tlmgTestAndSetRegOnOff`

Type: string

Value: 'on' | 'off'

Default: 'off'

See Also

“Test and Set Register” on page 17-17

Include tunable parameter registers in the memory map

The read/write tunable parameter registers are used by the initiator to change the values of the algorithm tunable parameters.

Settings

Default: On

On

Include tunable parameter registers in the memory map

Off

Do not include tunable parameter registers in the memory map

Dependencies

If you selected a combined TLM socket, **Auto-Generated Memory Map** enables this parameter.

If you selected separate TLM sockets, this parameter is automatically enabled for the control TLM socket.

Command-Line Information

Parameter: tlmgtunableParamRegOnOff

Type: string

Value: 'on' | 'off'

Default: 'on'

See Also

“Tunable Parameter Registers” on page 17-18

TLM Processing

Algorithm Step Function Execution

Choose the type of function execution trigger you want to use in the generated TLM component.

Settings

Default: SystemC Thread

- **SystemC Thread:** Event triggers system scheduler to execute function
- **Callback:** Function is executed as soon as input buffer is full or command is written to command register

Command-Line Information

Parameter: tlmAlgorithmProcessingType

Type: string

Value: 'SystemC Thread' | 'Callback'

Default: 'SystemC Thread'

See Also

“Algorithm Execution” on page 17-18

Algorithm step function timing (ns)

Specify the time in nanoseconds for modeling the algorithm execution time in the TLM environment.

Settings

Default: 100

Command-Line Information

Parameter: tlmAlgorithmProcessingTime

Type: int

Value:

Default: 100

See Also

“TLM Component Timing Values” on page 17-25

Enable temporal decoupling for loosely-timed simulation

Quantum allows loosely-timed simulation.

Note: This option will be removed in a future release. Generate your TLM component with the default settings instead.

Settings

Default: Off

On

Enable quantum for loosely-timed simulation. Allows you to specify the duration of the time quantum allocated to the generated TLM component in your system simulation.

Off

Do not enable quantum

Dependencies

This parameter enables **Maximum quantum for loosely-timed components (ns)**.

Command-Line Information

Parameter: tlmTempDecouplOnOff

Type: string

Value: 'on' | 'off'

Default: 'off'

See Also

“Temporal Decoupling” on page 17-20

Maximum quantum for loosely-timed components (ns)

Specify the time at which point temporally-decoupled components are forced to synchronize.

Note: This option will be removed in a future release. Generate your TLM component with the default settings instead.

Settings

Default: 1000

Dependencies

Enable quantum for loosely-timed simulation enables this parameter.

Command-Line Information

Parameter: tlmQuantumTime

Type: int

Value:

Default: 1000

See Also

“Temporal Decoupling” on page 17-20

Enable payload buffering

Payload buffering allows for initiators to write multiple input data sets for the algorithm step function and for the storage of multiple output data sets.

Note: This option will be removed in a future release. Generate your TLM component with the default settings instead. You can manually add a buffer to your SystemC environment if necessary.

Settings

Default: Off

On

Enable payload buffering. Enabling payload buffering allows for a different sample rate than was used in the original Simulink model.

Off

Do not enable payload buffering

Dependencies

This parameter enables **Payload input buffer depth** and **Payload output buffer depth**.

Note: This option will be removed in a future release. Generate your TLM component with the default settings instead. You can manually add a buffer to your SystemC environment if necessary.

Command-Line Information

Parameter: tlmPayloadBufferingOnOff

Type: string

Value: 'on' | 'off'

Default: 'off'

See Also

“Register and Buffering” on page 17-18

Payload input buffer depth

Choose the maximum number of possible outstanding input data sets before triggering algorithm execution.

Note: This option will be removed in a future release. Generate your TLM component with the default settings instead. You can manually add a buffer to your SystemC environment if necessary.

Settings

Default: 1

Dependencies

Enable payload buffering enables this parameter.

Command-Line Information

Parameter: `tlmgPayloadInBufferDepth`

Type: `int`

Value:

Default: 1

See Also

“Register and Buffering” on page 17-18

Payload output buffer depth

Choose the maximum number of possible outstanding output data sets after triggering algorithm execution.

Note: This option will be removed in a future release. Generate your TLM component with the default settings instead. You can manually add a buffer to your SystemC environment if necessary.

Settings

Default: 1

Dependencies

Enable payload buffering enables this parameter.

Command-Line Information

Parameter: `tlmgPayloadOutBufferDepth`

Type: `int`

Value:

Default: 1

See Also

“Register and Buffering” on page 17-18

Create an interrupt request port on the generated TLM component

Specify that an interrupt signal be added to the generated TLM component.

Settings

Default: Off

On

Create an interrupt request port on the generated TLM component. This signal will be asserted whenever new outputs are available in the output register(s) and will be automatically cleared whenever any value is read from the output register(s).

Off

Do not create an interrupt request port on the generated TLM component

Command-Line Information

Parameter: `timgIrqPortOnOff`

Type: string

Value: 'on' | 'off'

Default: 'on'

See Also

“Interrupt” on page 17-17

TLM Timing

Single write transfer or the first write transfer in a burst transaction (ns)

Specify the time in nanoseconds for the TLM component to execute a single write transfer or the first write transfer in a burst transaction.

Settings

Default: 10

Command-Line Information

Parameter: `tlmgFirstWriteTime` (for combined TLM socket) | `tlmgFirstWriteTimeInput` | `tlmgFirstWriteTimeCtrl`

Type: int

Value:

Default: 10

See Also

“TLM Component Timing Values” on page 17-25

Subsequent write transfers in a burst transaction (ns)

Specify the time in nanoseconds for the TLM component to execute a subsequent write transfer in a burst transaction.

Settings

Default: 10

Command-Line Information

Parameter: `tlmgSubsequentWritesInBurstTime` (for combined TLM socket) | `tlmgSubsequentWritesInBurstTimeInput` | `tlmgSubsequentWritesInBurstTimeCtrl`

Type: int

Value:

Default: 10

See Also

“TLM Component Timing Values” on page 17-25

Single read transaction or the first read transfer in a burst transaction (ns)

Specify the time in nanoseconds for the TLM component to execute a single read transaction or the first read transaction in a burst transaction.

Settings

Default: 10

Command-Line Information

Parameter: `tlmgFirstReadTime` (for combined TLM socket) |
`tlmgFirstReadTimeOutput` | `tlmgFirstReadTimeCtrl`

Type: int

Value:

Default: 10

See Also

“TLM Component Timing Values” on page 17-25

Subsequent read transfers in a burst transaction (in ns)

Specify the time in nanoseconds for the TLM component to execute a subsequent read transfer in a burst transaction.

Settings

Default: 10

Command-Line Information

Parameter: `tlmgSubsequentReadsInBurstTime` (for combined TLM socket) | `tlmgSubsequentReadsInBurstTimeOutput` | `tlmgSubsequentReadsInBurstTimeCtrl`

Type: int

Value:

Default: 10

See Also

“TLM Component Timing Values” on page 17-25

TLM Testbench

Generate testbench

Generate a standalone SystemC test bench in order to verify the generated TLM component using the same input stimulus as used in Simulink.

Settings

Default: On



On

Generate test bench for TLM component



Off

Do not generate test bench

Dependencies

This parameter enables all other parameters on this tab.

Command-Line Information

Parameter: tlmGenerateTestbench

Type: string

Value: 'on' | 'off'

Default: 'on'

See Also

“Testing TLM Components” on page 20-2

Generate verbose messages during testbench execution

Generate verbose messages during test bench execution.

Settings

Default: Off



On

Test bench generates verbose runtime messages



Off

Test bench does not generate verbose messages

Dependencies

Generate testbench enables this parameter.

Command-Line Information

Parameter: tlmgVerboseTbMessagesOnOff

Type: string

Value: 'on' | 'off'

Default: 'off'

See Also

“Verbose Messaging” on page 20-5

Run-time timing mode

Specify the timing mode to be used by the generated test bench and TLM component.

Settings

Default: With timing

- **With timing:** The target annotates TLM component transactions with delays and the initiator will honor them. When a quantum keeper is not used (see “Temporal Decoupling” on page 17-20), the initiator synchronizes immediately following the transaction execution. When a quantum keeper is used, the initiator utilizes temporal decoupling and does not synchronize to the annotated delays until the quantum is reached.
- **Without timing:** The target does not annotate TLM component transaction with any delays. The initiator and target only perform synchronization using zero-time wait calls.

Dependencies

Generate testbench enables this parameter.

Command-Line Information

Parameter: `tlmgRuntimeTimingMode`

Type: `string`

Value: `'With timing' | 'Without timing'`

Default: `'With timing'`

See Also

“Run-Time Timing Mode” on page 20-5

Input buffer triggering mode

Specify when data is moved from the input register to the execution buffer. In your TLM environment, this specification is done via a runtime configuration command and can be changed dynamically throughout simulation.

Settings

Default: Automatic

- **Automatic:** The TLM component automatically moves input data sets from the input registers to the input buffer.
- **Manual:** The initiator must explicitly write a command to the command and status register in order to move the input data set from the register to the input buffer.

Dependencies

The following parameters must each be selected to enable the **Input buffer triggering mode** parameter:

- **Include a command and status register in the memory map:** Must be selected.
- **Generate testbench:** Must be selected.

Command-Line Information

Parameter: `tlmgInputBufferTriggerMode`

Type: `string`

Value: `'Automatic' | 'Manual'`

Default: `'Automatic'`

See Also

“Input and Output Buffer Triggering Modes” on page 20-5

Output buffer triggering mode

Specify when data is moved from the results buffer to the output register. In your TLM environment, this specification is done via a runtime configuration command and can be changed dynamically throughout simulation.

Settings

Default: Automatic

- **Automatic:** The TLM component automatically moves output data sets from the output buffer to the output registers.
- **Manual:** The initiator must explicitly write a command to the command and status register in order to move the output data set from the output buffer to the output registers.

Dependencies

The following parameters must each be selected to enable the **Input buffer triggering mode** parameter:

- **Include a command and status register in the memory map:** Must be selected.
- **Generate testbench:** Must be selected.

Command-Line Information

Parameter: tlmOutputBufferTriggerMode

Type: string

Value: 'Automatic' | 'Manual'

Default: 'Automatic'

See Also

“Input and Output Buffer Triggering Modes” on page 20-5

TLM Compilation

SystemC include path

Specify the SystemC include path. This string is written directly into the generated makefiles. The default is chosen such that if you define the environment variable you should be able to update your SystemC/TLM installation without having to update your Simulink models.

Settings

Default: `$(SYSTEMC_INC_PATH)`

Command-Line Information

Parameter: `tlmgSystemCIncludePath`

Type: `string`

Value:

Default: `'$(SYSTEMC_INC_PATH)'`

See Also

“TLM Component Compiler Options” on page 21-2

SystemC library path

Specify the location of the library directory in your SystemC installation. This string is written directly into the generated makefiles. The default is chosen such that if you define the environment variable you should be able to update your SystemC/TLM installation without having to update your Simulink models.

Settings

Default: \$(SYSTEMC_LIB_PATH)

Command-Line Information

Parameter: tlmSystemCLibPath

Type: string

Value:

Default: '\$(SYSTEMC_LIB_PATH)'

See Also

“TLM Component Compiler Options” on page 21-2

SystemC library name

Specify the name of the SystemC library in your SystemC installation. This string is written directly into the generated makefiles. The default is chosen such that if you define the environment variable you should be able to update your SystemC/TLM installation without having to update your Simulink models.

Settings

Default: \$(SYSTEMC_LIB_NAME)

Command-Line Information

Parameter: tlmSystemCLibName

Type: string

Value:

Default: '\$(SYSTEMC_LIB_NAME)'

See Also

“TLM Component Compiler Options” on page 21-2

TLM include path

Specify the location of the TLM include directory in your TLM installation. This string is written directly into the generated makefiles. The default is chosen such that if you define the environment variable you should be able to update your SystemC/TLM installation without having to update your Simulink models.

Settings

Default: `$(TLM_INC_PATH)`

Command-Line Information

Parameter: `tlmgTLMIncludePath`

Type: `string`

Value:

Default: `'$(TLM_INC_PATH)'`

See Also

“TLM Component Compiler Options” on page 21-2

SCML include path

Specify the SCML include path. This string is written directly into the generated makefiles. The default is chosen such that if you define the environment variable you should be able to update your SCML installation without having to update your Simulink models.

Settings

Default: \$(SCML_INC_PATH)

Command-Line Information

Parameter: tlmgSCMLIncludePath

Type: string

Value:

Default: '\$(SCML_INC_PATH)'

See Also

“TLM Component Compiler Options” on page 21-2

SCML library path

Specify the SCML library path. This string is written directly into the generated makefiles. The default is chosen such that if you define the environment variable you should be able to update your SCML installation without having to update your Simulink models.

Settings

Default: \$(SCML_LIB_PATH)

Command-Line Information

Parameter: tlmSCMLLibPath

Type: string

Value:

Default: '\$(SCML_LIB_PATH)'

See Also

“TLM Component Compiler Options” on page 21-2

SCML library name

Specify the SCML library name. This string is written directly into the generated makefiles. The default is chosen such that if you define the environment variable you should be able to update your SCML installation without having to update your Simulink models.

Settings

Default: \$(SCML_LIB_NAME)

Command-Line Information

Parameter: tlmSCMLLibName

Type: string

Value:

Default: '\$(SCML_LIB_NAME)'

See Also

“TLM Component Compiler Options” on page 21-2

SCML logging library name

Specify the name of the SCML logging library. This string is written directly into the generated makefiles. The default is chosen such that if you define the environment variable you should be able to update your SCML installation without having to update your Simulink models.

Settings

Default: \$(SCML_LOGGING_LIB_NAME)

Command-Line Information

Parameter: tlmSCMLLoggingLibName

Type: string

Value:

Default: '\$(SCML_LOGGING_LIB_NAME)'

See Also

“TLM Component Compiler Options” on page 21-2

Toolchain

Specify a compiler from the drop-down list. The available options list the compiler versions installed on your computer; the default option is the version most recently installed.

Settings

Available options are compiler versions installed on your computer; default option is version most recently installed.

Command-Line Information

Parameter: `tlmgCompilerSelect`

Type: string

Value:

Default: Linux — GCC, Windows — Visual Studio 20XX, where XX is the version most recently installed.

See Also

“TLM Component Compiler Options” on page 21-2

User-defined tag for TLM component names

Add additional text to your TLM component class name identifier, the input and output data structures, and the directory to place the generated code.

Settings**No Default****Command-Line Information**

Parameter: `tlmgUserTagForNaming`

Type: `string`

Value:

Default:

See Also

“TLM Component Naming and Packaging” on page 17-26

SystemVerilog DPI Component Generation

DPI Component Generation for MATLAB Function

- “DPI Component Generation with MATLAB” on page 23-2
- “Supported MATLAB Data Types” on page 23-3
- “Generated Shared Library” on page 23-5
- “Generated Test Bench” on page 23-6
- “Generated Outputs” on page 23-7
- “Generated SystemVerilog Wrapper” on page 23-8
- “Limitations” on page 23-9

DPI Component Generation with MATLAB

You can export a MATLAB function as a component with a direct programming interface (DPI) for use in a SystemVerilog simulation. Wrap generated C code with a DPI wrapper that communicates with a SystemVerilog thin interface function in a SystemVerilog simulation.

For MATLAB, you generate the component using the `dpigen` function.

Note: You must have a MATLAB Coder license to use this feature.

Related Examples

- “Create MATLAB Function and Test Bench” on page 24-2
- “Generate SystemVerilog DPI Component” on page 24-4
- “Run Generated Test Bench in HDL Simulator” on page 24-8
- “Use Generated DPI-C Functions in SystemVerilog” on page 24-10

More About

- “Supported MATLAB Data Types” on page 23-3
- “Generated Shared Library” on page 23-5
- “Generated Test Bench” on page 23-6
- “Generated Outputs” on page 23-7
- “Generated SystemVerilog Wrapper” on page 23-8
- “Limitations” on page 23-9

Supported MATLAB Data Types

Supported MATLAB data types are converted to SystemVerilog data types, as shown in the following table.

MATLAB	SystemVerilog
uint8	byte unsigned
uint16	shortint unsigned
uint32	int unsigned
uint64	longint unsigned
int8	byte
int16	shortint
int32	int
int64	longint
single	shortreal
double	real
logical	bit
fi (fixed-point data type)	Depends on the fixed point word length. If the fixed point word length is greater than the host word size (for example, 64-bit vs. 32-bit), then this data type cannot be converted to a SystemVerilog data type by MATLAB Coder and you will get an error. If the fixed point word length is less than or equal to the host word size, MATLAB Coder converts the fixed-point data type to a built-in C type.
complex	The coder flattens complex signals into real and imaginary parts in the SystemVerilog component.
vectors, matrices	arrays

MATLAB	SystemVerilog
	For example, a 4-by-2 matrix in MATLAB is converted into a one-dimensional array of 8 elements in SystemVerilog.
structure	The coder flattens structure elements into separate ports in the SystemVerilog component.

Generated Shared Library

Function `dpigen` automatically compiles the shared library needed to run the exported DPI Component in the SystemVerilog environment. The makefile that builds the shared library has the extension `_rtw.mk`. For example, for `fun.m`, the make file name is `fun_rtw.mk`.

During compilation, the function `dpigen` generates a library file.

- Windows 64: `function_win64.dll`
- Linux: `function.so`

function is the name of the MATLAB function you generated the DPI component from.

Note: If you use 64-bit MATLAB on Windows, you get a 64-bit DLL, which can be used only with a 64-bit HDL simulator.

Make sure that your MATLAB version matches your HDL simulator version.

Generated Test Bench

Function `dpigen` also creates a test bench. You can use this test bench to verify that the generated SystemVerilog component is functionally equivalent to the original MATLAB function. This test bench is not intended as a replacement for a system test bench for your own application. However, you can use the generated test bench as a starting example when creating your own system test bench.

Generated Outputs

- C and header files from your algorithm, generated by MATLAB Coder
- C and header files for the DPI wrapper, generated by HDL Verifier
- SystemVerilog file that exposes the component and adds control signals
- SystemVerilog test bench (with the `-testbench` option)
- Data files used with the HDL simulator (with the `-testbench` option)
- HDL simulator scripts, such as `*.do` or `*.sh` (with the `-testbench` option)
- Makefile `*.mk`

Generated SystemVerilog Wrapper

All SystemVerilog code generated by function `dpigen` contains a set of control signals and the `Initialize` function.

Generated Control Signals

- `clk`: synchronization clock
- `clk_enable`: clock enable
- `reset`: asynchronous reset

Generated Initialize Function

The `Initialize` function is called at the beginning of the simulation.

For example:

```
import "DPI-C" function void DPI_Subsystem_initialize();
```

If the asynchronous reset signal is high (goes from 0 to 1), `Initialize` is called again.

Limitations

- Variable-sized arguments are not supported.
- Large fixed-point numbers that exceed the system word length are not supported.
- Some optimizations, such as constant folding, are not supported because they change the interface of the generated C function. For more information, see “MATLAB Coder Optimizations in Generated Code”.
- HDL Verifier limits matrices and vectors to one-dimensional arrays in SystemVerilog. For example, a 4-by-2 matrix in MATLAB is converted to a one-dimensional array of 8 elements in SystemVerilog.
- The PostCodegen callback in config objects is not supported.

DPI Component Generation (MATLAB)

Generate DPI Component Using MATLAB

In this section...

“Create MATLAB Function and Test Bench” on page 24-2

“Generate SystemVerilog DPI Component” on page 24-4

“Run Generated Test Bench in HDL Simulator” on page 24-8

“Use Generated DPI-C Functions in SystemVerilog” on page 24-10

“Port Generated Component and Test Bench to Linux” on page 24-11

Create MATLAB Function and Test Bench

- “Create MATLAB Function” on page 24-2
- “Create Test Bench” on page 24-3
- “Run Test Bench” on page 24-3

Create MATLAB Function

Code the MATLAB function you want to export to a SystemVerilog environment. For information about coding MATLAB functions, see "Function Basics" in the MATLAB documentation.

Consider adding the compilation directive `%#codegen` to your function. This directive can help you diagnose and fix violations that would result in errors during code generation. See “Compilation Directive `%#codegen`”.

While you code your function, keep in mind the “Limitations” on page 23-9, which describe the various aspects of DPI component generation that you must know. These aspects include which data types are valid, what files are generated, and how the shared libraries are compiled.

In this example, the MATLAB function `fun.m` takes a single input and multiplies it by 2. The function includes the compilation directive `%#codegen`.

```
function y = fun(x);  
%#codegen  
y = x * 2;
```

The process of creating the MATLAB includes writing the code, creating the test bench, and running the test bench in an iterative process. When you are satisfied that your function does what you intend it to do, continue on to “Generate SystemVerilog DPI Component” on page 24-4.

Create Test Bench

Create a test bench to exercise the function. In this example, the test bench applies a test vector against `fun.m` and plots the output.

```
function sample=fun_tb
% Testbench should not require input, however you can give an output.

% Define a test vector
tVecIn = [1,2,3,4,5];

% Exercise fun.m and plot results to make sure function is working correctly
tVecOut = arrayfun(@(in) fun(in),tVecIn);
plot(tVecIn,tVecOut);
grid on;

% Get my sample input to use it with function dpigen.
sample = tVecIn(1);
```

Note that a test bench should not have inputs. The test bench can load test vectors using MAT files or any other data file, so it does not require inputs.

The output of `fun_tb`, `sample`, is going to be used as the function inputs argument for `fun.m` during the call to `dpigen`, which is why it is a single element. See “Generate SystemVerilog DPI Component” on page 24-4.

Run Test Bench

```
fun_tb
ans =
     1
```

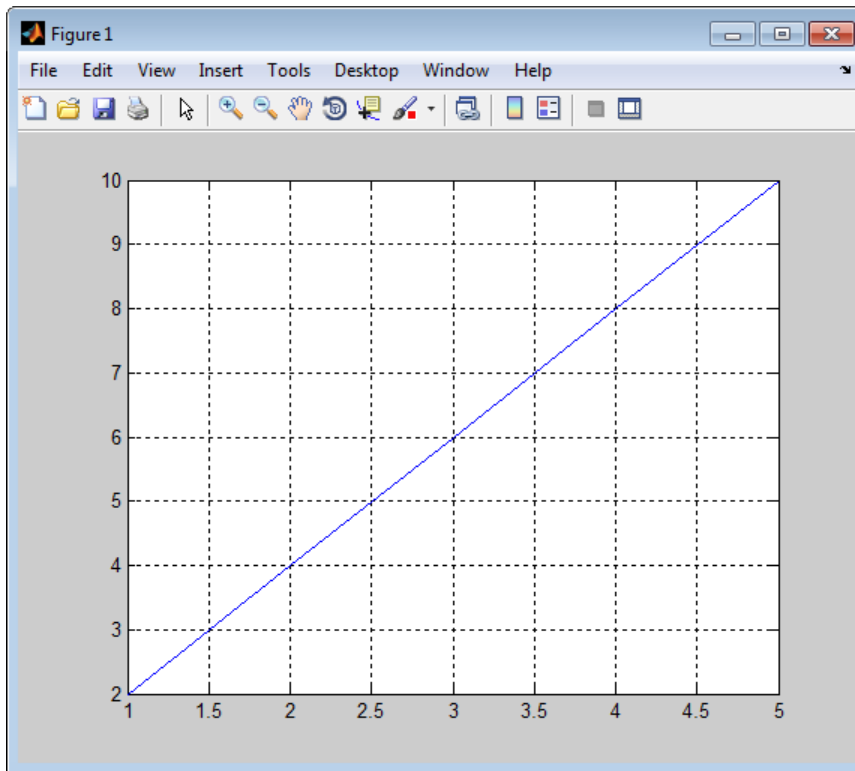

Next, generate the SystemVerilog DPI component. See “Generate SystemVerilog DPI Component” on page 24-4.

Generate SystemVerilog DPI Component

- “Generate DPI Component with `dpigen` Function” on page 24-4
- “Examine Generated Component” on page 24-6
- “Examine Generated Test Bench” on page 24-6

Generate DPI Component with `dpigen` Function

Use the function `dpigen` to generate the DPI component. This function has several optional input arguments. At a minimum, specify the MATLAB function you want to generate a component for and the function inputs. If you also want to generate a test bench to exercise the generated component, use the `-testbench` option.

```
dpigen func -args input_arg -testbench test_bench_name
```

- 1 Define the inputs as required by the function. In this example, `sample` is a scalar value of type double.

```
sample = 1;
```

- 2 Call the DPI component generator function:

```
dpigen fun -args sample -testbench fun_tb
```

The command, issued as shown, performs the following tasks:

- Generates a SystemVerilog component for the function `fun.m`. The function inputs for `fun.m` are specified in `sample`.
- Creates a test bench for the generated component.

For this call to `dpigen`, MATLAB outputs the following messages:

```
### Generating DPI-C Wrapper fun_dpi.c
### Generating DPI-C Wrapper header file fun_dpi.h
### Generating SystemVerilog module fun_dpi.sv
### Generating makefiles for: fun_dpi
### Generating SystemVerilog test bench fun_tb_sv
### Generating test bench simulation script for Mentor Graphics ModelSim/Questasim run_tb_mq.do
### Generating test bench simulation script for Cadence Incisive run_tb_ncsim.sh
### Generating test bench simulation script for Synopsys VCS run_tb_vcs.sh
```

The function shown in the previous example generates the following folders and files:

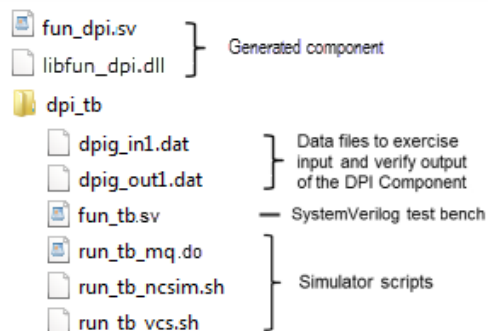

Examine Generated Component

Examine the generated component so that you can understand how the `dpigen` function converted MATLAB code to SystemVerilog code. For more information on what the function includes, see “Generated SystemVerilog Wrapper” on page 23-8.

This example shows the code generated for `fun_dpi.sv`.

```
// File: C:\Work\dpicml\codegen\dll\fun\fun_dpi.sv
// Created: 2014-04-30 14:48:07
// Generated by MATLAB 8.4 and HDL Verifier 4.5

`timescale 1ns / 1ns

module fun_dpi(
    input clk,
    input clk_enable,
    input reset,
    input real x,
    output real y
);

    // Declare imported C functions
    import "DPI-C" function void DPI_fun_initialize();
    import "DPI-C" function void DPI_fun(input real x,output real y);

    initial begin
        DPI_fun_initialize();
    end

    always @(posedge clk or posedge reset) begin
        if(reset == 1'b1) begin
            DPI_fun_initialize();
        end
        else if(clk_enable) begin
            DPI_fun(x,y);
        end
    end
endmodule
```

Examine Generated Test Bench

Examine the generated test bench so you can see how function `dpigen` created this test bench from the MATLAB code. For more information on the generated test bench, see “Generated Test Bench” on page 23-6

This example shows the code generated for `fun_tb.sv`.

```
// File: /codegen/dll/fun/dpi_tb/fun_tb.sv
// Created: 2014-04-22 21:16:29
// Generated by MATLAB 8.4 and HDL Verifier 4.5

`timescale 1ns / 1ns
module fun_tb;
    real x;
    real y;
    real y_read;
```

```

real y_ref;
// File Handles
integer fid_x;
integer fid_y;
// Other test bench variables
bit clk;
bit clk_enable;
bit reset;
integer fscanf_status;
reg testFailure;
reg tbDone;
bit[63:0] real_bit64;
bit[31:0] shortreal_bit64;
parameter CLOCK_PERIOD= 10;
parameter CLOCK_HOLD= 2;
parameter RESET_LEN= 2*CLOCK_PERIOD+CLOCK_HOLD;
// Initialize variables
initial begin
    clk = 1;
    clk_enable = 0;
    testFailure = 0;
    tbDone = 0;
    reset = 1;
    fid_x = $fopen("dpig_in1.dat","r");
    fid_y = $fopen("dpig_out1.dat","r");
    #RESET_LEN reset = 0;
end
// Clock
always #(CLOCK_PERIOD/2) clk = ~ clk;
always@(posedge clk) begin
if (reset == 0) begin
    #CLOCK_HOLD
    clk_enable <= 1;
    fscanf_status = $fscanf(fid_x, "%h", real_bit64);
    x = $bitstoreal(real_bit64);
    if ($feof(fid_x))
        tbDone = 1;
    fscanf_status = $fscanf(fid_y, "%h", real_bit64);
    y_read = $bitstoreal(real_bit64);
    if ($feof(fid_y))
        tbDone = 1;
    y_ref <= y_read;
    if (tbDone == 1) begin
        if (testFailure == 0)
            $display
                ("*****TEST COMPLETED (PASSED)*****");
        else
            $display
                ("*****TEST COMPLETED (FAILED)*****");
        $finish;
    end
    if (clk_enable == 1) begin
        assert
            ( ((y_ref - y) < 2.22045e-16) && ((y_ref - y) > -2.22045e-16) )
        else begin
            testFailure = 1;
            $display("ERROR in output y_ref at time %t :", $time);
            $display("Expected %e; Actual %e; Difference %e", y_ref, y, y_ref-y);
        end
    end
end
end
end
end

```

```

// Instantiate DUT
fun_dpi u_fun_dpi(
    .clk(clk),
    .clk_enable(clk_enable),
    .reset(1'b0),
    .x(x),
    .y(y)
);
endmodule

```

Next, run the generated test bench in the HDL simulator. See “Run Generated Test Bench in HDL Simulator” on page 24-8. If you plan to port the component and optional test bench from Windows to Linux, see “Port Generated Component and Test Bench to Linux” on page 24-11.

Run Generated Test Bench in HDL Simulator

- “Run Test Bench in ModelSim and QuestaSim Simulators” on page 24-8
- “Run Test Bench in Incisive Simulator” on page 24-9
- “Run Test Bench in VCS Simulator” on page 24-10

This section includes instructions for running the generated test bench in one of the supported HDL simulators: Mentor Graphics ModelSim and QuestaSim, Cadence Incisive, and Synopsys VCS®. It is possible that this code will work in other (unsupported) HDL simulators but it is not guaranteed.

Choose the workflow for your HDL simulator.

Run Test Bench in ModelSim and QuestaSim Simulators

- 1 Start ModelSim or QuestaSim in GUI mode.
- 2 Change your current directory to the `dpi_tb` folder under the code generation directory in MATLAB.
- 3 Enter the following command in the shell to start your simulation:

```
do run_tb_mq.do
```

This generated script contains the name of the component and test bench, and instructions to the HDL simulator for running the test bench.

When the simulation finishes, you should see the following text displayed in your console:

```
*****TEST COMPLETED (PASSED)*****
```

This message tells you that the test bench was run against the generated component successfully.

The following wave form image from this example demonstrates that the generated test bench was successfully exercised in the HDL simulator.

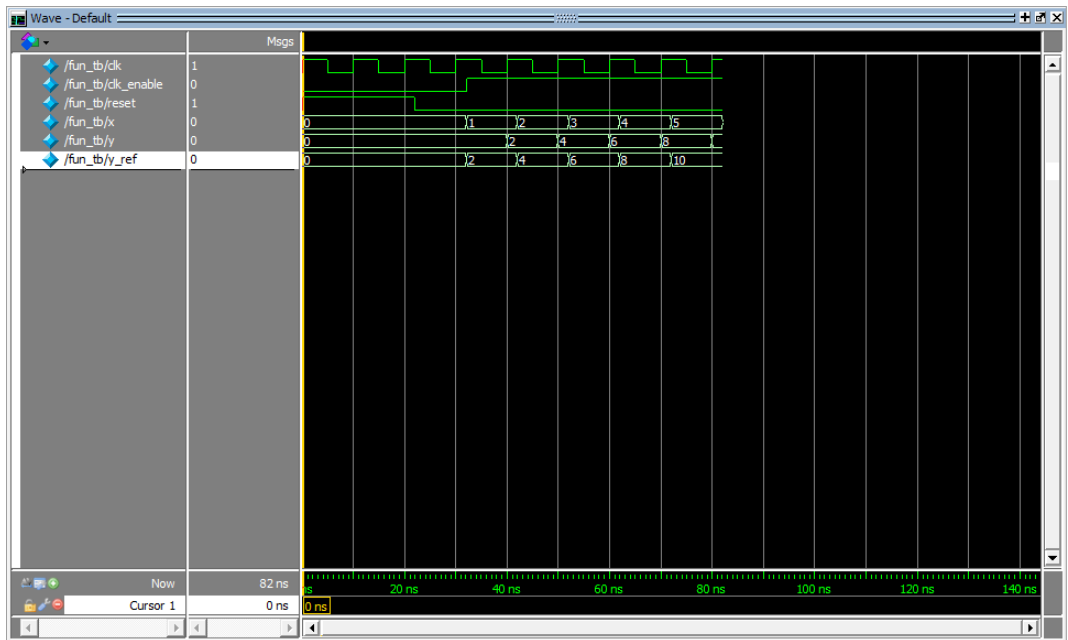

Next, import your component. See “Use Generated DPI-C Functions in SystemVerilog” on page 24-10.

Run Test Bench in Incisive Simulator

- 1 Launch Incisive.
- 2 Start your terminal shell.
- 3 Change the current directory to `dpi_tb` under the code generation directory in MATLAB.
- 4 Enter the following command in the shell to start the simulation:

```
sh run_tb_ncsim.sh
```

This generated script contains the name of the component and test bench, and instructions to the HDL simulator for running the test bench.

When the simulation finishes, you should see the following text displayed in your console:

```
*****TEST COMPLETED (PASSED)*****
```

This message tells you that the test bench was run against the generated component successfully.

Run Test Bench in VCS Simulator

- 1 Launch VCS.
- 2 Start your terminal shell.
- 3 Change the current directory to `dpi_tb` under the code generation directory in MATLAB.
- 4 Enter the following command in your shell to start the simulation:

```
sh run_tb_vcs.sh
```

This generated script contains the name of the component and test bench, and instructions to the HDL simulator for running the test bench.

When the simulation finishes, you should see the following text displayed in your console:

```
*****TEST COMPLETED (PASSED)*****
```

This message tells you that the test bench was run against the generated component successfully.

Use Generated DPI-C Functions in SystemVerilog

To use the generated DPI component in a SystemVerilog environment, first you must import the generated functions with “DPI” declarations within your SystemVerilog module. Then, you must call the generated functions. When you compile the SystemVerilog code that contains the imported generated functions, use a DPI-aware SystemVerilog compiler and specify the component file names along with the SystemVerilog code.

The following example demonstrates adding the generated DPI component for `fun.m` to a SystemVerilog module.

- 1 Explicitly import the generated functions.

```
// Declare imported C functions
import "DPI-C" function void DPI_fun_initialize();
import "DPI-C" function void DPI_fun(input real x, output real y);
```

- 2 Next, call the Initialize function.

```
DPI_fun_initialize();
```

- 3 Call the function generated from `fun.m`.

```
DPI_fun(x,y);
```

You can now modify the generated code as needed.

Example

```
// Declare imported C functions
import "DPI-C" function void DPI_fun_initialize();
import "DPI-C" function void DPI_fun(input real x, output real y);

module test_twofun_tb;

    initial begin
        DPI_fun_initialize();
    end

    always@(posedge clk) begin
        #1
        DPI_fun(x,y);
    end
end
```

Port Generated Component and Test Bench to Linux

To port the component and optional test bench from a Windows operating system to a Linux operating system, follow these instructions.

Note: You must have an Embedded Coder license for the Windows to Linux port. Although it is possible the port will work without the Embedded Coder license, that usage is not supported.

- “Step 1. Tasks on the Windows Host Machine” on page 24-12
- “Step 2. Tasks on the Linux Target Machine” on page 24-12

Step 1. Tasks on the Windows Host Machine

- 1 Create a MATLAB Coder `config` object. Change the target HW device type to LP64 for the Linux operating system.

```
cfg=coder.config('dll');
cfg.HardwareImplementation.TargetHWDeviceType='Generic->64-bit Embedded Processor (LP64)';
```

- 2 Run the `dpigen` command using option `-config` to use the `config` object that you created in step 1. Use option `-c` so that function `dpigen` generates only code. For example:

```
dpigen -config cfg DataTypes.m -args InputSample -c
```

- 3 To generate a zip file to port to Linux, change folder to the source folder (where the `buildInfo.mat` file is generated), and execute the following commands at the command prompt:

```
load buildInfo
buildInfo.packNGo()
```

- 4 To copy the file for porting, return to the top level folder. Find the zip file generated in the previous step (same name as the MATLAB function). Copy the zip file to the Linux machine.

Step 2. Tasks on the Linux Target Machine

- 1 Unzip the file using the `-j` option to extract all the files with a flattened folder structure. You can unzip into any folder. For example:

```
unzip -j DataTypes.zip
```

- 2 **a** Copy this generic makefile script into an empty file:

```
SRC=$(wildcard *.c)
OBJ=$(SRC:.c=.o)

SHARE_LIB_NAME=DPI_Component.so

all: $(SRC) $(SHARE_LIB_NAME)
    @echo "### Successfully generated all binary outputs."

$(SHARE_LIB_NAME): $(OBJ)
    gcc -shared -lm $(OBJ) -o $@

.c.o:
    gcc -c -fPIC -Wall -ansi -pedantic -Wno-long-long -fwrapv -O0 $< -o $@
```

- b** Replace `DPI_Component.so` with the name of the shared library you want to create.

c Save the script as `Porting_DPIC.mk` in the folder where the zip files were extracted.

3 Build the shared library with the following command:

```
make -f Porting_DPIC.mk all
```

To use the generated component with SystemVerilog, see “Use Generated DPI-C Functions in SystemVerilog” on page 24-10.

4 (Optional) Run the test bench that was automatically generated in Windows.

a Copy the contents of the `dpi_tb` folder from the Windows host machine to the Linux target machine.

b Run the test bench.

To run the test bench in an HDL simulator, see “Run Generated Test Bench in HDL Simulator” on page 24-8.

DPI Component Generation for Simulink Subsystem

- “DPI Component Generation with Simulink” on page 25-2
- “Determine Workflow for DPI-C Target” on page 25-10

DPI Component Generation with Simulink

In this section...

“DPI-C Generation Overview” on page 25-2

“Supported Simulink Data Types” on page 25-3

“Generated SystemVerilog Wrapper” on page 25-3

“Customization” on page 25-7

“Generated Test Bench” on page 25-8

“Limitations” on page 25-8

DPI-C Generation Overview

If you have a Simulink Coder license, you can generate SystemVerilog DPI components using one of two methods.

Export SystemVerilog DPI Component for Subsystem

HDL Verifier integrates with Simulink Coder to export a subsystem as generated C code inside a SystemVerilog component with a Direct Programming Interface (DPI). You can integrate this component into your HDL simulation as a behavioral model. The coder provides options to customize the generated SystemVerilog structure. The component generator supports test point access and tunable parameters. The coder optionally generates a SystemVerilog test bench that verifies the generated DPI component against data vectors from your Simulink subsystem. This feature is available in the Model Configuration Parameters dialog box, under **Code Generation**. See “Generate SystemVerilog DPI Component” on page 26-2.

Generate SystemVerilog DPI Test Bench in HDL Coder

If you have an HDL Coder license, you can generate a SystemVerilog DPI test bench. Use the test bench to verify your generated HDL code using C code generated from your entire Simulink model, including the DUT and data sources. To use this feature, your entire model must support C code generation with Simulink Coder. See the `GenerateSVDPI TestBench` property of `makehdl1tb`.

Supported Simulink Data Types

Supported Simulink data types are converted to SystemVerilog data types, as shown in the following table.

Simulink	SystemVerilog
uint8	byte unsigned
uint16	shortint unsigned
uint32	int unsigned
uint64	longint unsigned
int8	byte
int16	shortint
int32	int
int64	longint
single	shortreal
double	real
boolean	bit
complex	The coder flattens complex signals into real and imaginary parts in the SystemVerilog interface.
vectors, matrices	arrays For example, a 4-by-2 matrix in Simulink is converted into a one-dimensional array of eight elements in SystemVerilog.
non-virtual bus	The coder flattens the bus into separate component signals in the SystemVerilog interface.

Embedded Coder converts fixed data types to one of the supported Simulink data types.

Generated SystemVerilog Wrapper

- “Generated Control Signals” on page 25-4
- “Generated Component Functions” on page 25-4

- “Parameter Tuning” on page 25-5
- “Test Point Access Functions” on page 25-6
- “Extra Sample Delay” on page 25-6

Generated Control Signals

All SystemVerilog code generated by the SystemVerilog DPI generator contains these control signals:

- `clk`: synchronization clock
- `clk_enable`: clock enable
- `reset`: asynchronous reset

Generated Component Functions

SystemVerilog code generated by the SystemVerilog DPI generator contains these functions:

```
// Declare imported C functions
import "DPI-C" function chandle DPI_subsystemname_initialize(chandle existhandle);
import "DPI-C" function void DPI_subsystemname_output(input chandle objhandle, input
import "DPI-C" function void DPI_subsystemname_update(input chandle objhandle, input
import "DPI-C" function void DPI_subsystemname_terminate(input chandle objhandle);
```

Where *subsystem* is the name of the subsystem you generated code for.

If your model also contains tunable parameters, see “Parameter Tuning” on page 25-5.

- Initialize function

The `Initialize` function is called at the beginning of the simulation.

For example, for a subsystem titled `dut`:

```
initial begin
    objhandle = DPI_dut_initialize(objhandle);
end
```

- Output function

At the positive edge of clock, if `clk_enable` is high, the output function is called first, and then the update function is called.

For example, for a subsystem titled `dut`:

```
if(clk_enable) begin
    DPI_dut_output(objhandle, dut_U_In1, dut_Y_Out1);
    DPI_dut_update(objhandle, dut_U_In1);
end
```

- Update function

At the positive edge of clock, if `clk_enable` is high, the update function is called *after* the output function.

For example, for a subsystem titled `dut`:

```
if(clk_enable) begin
    DPI_dut_output(objhandle, dut_U_In1, dut_Y_Out1);
    DPI_dut_update(objhandle, dut_U_In1);
end
```

- Terminate function

Set specific conditions for early termination of simulation.

For example, for a subsystem titled `dut`:

```
if (condition for termination) begin
    DPI_dut_terminate(objhandle);
end
```

The function details in the SystemVerilog code generated from your system vary. You can examine the generated code for specifics. For an example of the generated functions in context, see the example “Getting Started with SystemVerilog DPI Component Generation”.

Parameter Tuning

You may want to run different simulations with various values for the parameters in your Simulink model. If your system has tunable parameters, the generated SystemVerilog code also contains a Set Parameter function for each tunable parameter.

The DPI component generator generates a Set Parameter function for each tunable parameter in the format `DPI_subsystemname_setparam_tunableparametername`.

In this example, the tunable gain parameter has its own `setparam_gain` function.

```
import "DPI-C" function void DPI_dut_setparam_gain(input chandle objhandle, input real
```

The generated SystemVerilog code does not call this function. Instead, the default parameters are used. To change those parameters during simulation, explicitly call the specific `setparam` function. For example, in the subsystem titled `dut`, you can change the gain during simulation to a value of 6 by inserting the following call:

```
DPI_dut_setparam_gain(objhandle, 6);
```

To make a parameter tunable, create a data object from your subsystem before generating the SystemVerilog code. See the tutorial “Tune Gain Parameter During Simulation” on page 26-16.

Test Point Access Functions

This feature enables you to access internal signals of the SystemVerilog DPI component in your HDL simulator. You can designate internal signals in your model as test points and configure the SystemVerilog DPI generator to create individual or grouped access functions.

You can also enable logging on test points and use the generated test bench to compare logged data from Simulink with values observed while running the SystemVerilog component.

See “SystemVerilog DPI Component Test Point Access” on page 26-13 and “Getting Started with SystemVerilog DPI Component Generation”.

Extra Sample Delay

Compared with the original Simulink model, the generated SystemVerilog module introduces one extra sample delay at the output. For example, in the following Simulink model, the output is one-sample delayed version of the input signal.



The generated C code preserves this behavior, and the output comprises one sampled delayed version of the input signal. However, in the SystemVerilog wrapper file, the clock signal is used to synchronize the input and output signals:

```

always @(posedge clk) begin
    DPI_blk2_output(blk2_U_In1, blk2_Y_Out1);
    DPI_blk2_update();
end

```

The output of the SystemVerilog module can only be updated on the rising edge of the clock. This requirement introduces an extra sample delay, as the next figure shows.



Customization

You can customize the generated SystemVerilog wrapper by modifying the template shipped with HDL Verifier (`svdpi_grt_template.vgt`). Alternatively, you can create your own custom template. Provide anchors for the generated code in your template and to verify that the template generates valid SystemVerilog code.

The default SystemVerilog template, provided by HDL Verifier, is `svdpi_grt_template.vgt`. In this template, special `clken_in` and `clken_out` control signals are added to the SystemVerilog module interface.

You can generate SystemVerilog DPI components from multiple subsystems and connect them together in an HDL Simulator. When you do so, these control signals determine the execution order of those components. They also minimize the delay between the Simulink signal and the SystemVerilog signal.

You can also specify your own template file with the following conditions:

- The file must be on the MATLAB path and searchable.
- The file must have a `.vgt` extension.

You can use these optional tokens to customize the generated code by inserting them inside comment statements throughout the template:

- `%<FileName>`
- `%<PortList>`
- `%<ImportInitFunction>`

- %<ImportOutputFunction>
- %<ImportUpdateFunction>
- %<ImportSetParamFunction>
- %<CallInitFunction>
- %<CallUpdateFunction>
- %<CallOutputFunction>

See “Customize Generated SystemVerilog Code” on page 26-6 for step-by-step instructions on customizing your code.

Note: The SystemVerilog DPI component generator does not generate a test bench for a component that has been customized.

Generated Test Bench

The SystemVerilog DPI component generator also creates a test bench. You can use this test bench to verify that the generated SystemVerilog component is functionally equivalent to the original Simulink subsystem. This test bench is not intended as a replacement for a system test bench for your own application. However, you can use the generated test bench as a starting example for your own system test bench.

If you enable logging on designated test points in your model, the generated test bench also compares internal signal values in the SystemVerilog component with logged values from Simulink.

Note: HDL Verifier does not support test bench generation for custom generated SystemVerilog code. See “Customization” on page 25-7.

Limitations

- If you have matrices or vectors, HDL Verifier limits them to one-dimensional array in SystemVerilog. For example, a 4-by-2 matrix in Simulink is converted to a one-dimensional array of eight elements in SystemVerilog.
- SystemVerilog DPI Component Generation supports the following subsystems for code generation only:

- Multirate
- Triggered subsystem
- Enabled subsystem
- Subsystem with action port

There is no test bench support for these subsystems.

For best results, avoid exporting multiple subsystems separately because it can be difficult to achieve the correct execution order. Instead, combine multiple subsystems into one and generate code from the newly created, single subsystem.

Related Examples

- “Generate SystemVerilog DPI Component” on page 26-2
- “Port and Build Shared Libraries and Simulator Projects” on page 26-22
- “Customize Generated SystemVerilog Code” on page 26-6
- “Verify Generated Component Against Simulink Data” on page 26-10
- “Use Generated DPI-C Functions in SystemVerilog” on page 26-11

More About

- “Determine Workflow for DPI-C Target” on page 25-10

Determine Workflow for DPI-C Target

You can export a Simulink subsystem to a component with a DPI interface for use in a Verilog or SystemVerilog simulation.

You can customize DPI-C generation for ModelSim or Incisive (Linux only), or you can generate a generic DLL. The exact procedure depends on your host computer operating system, the target operating system, and whether you want a generic shared library or an HDL simulator project.

Select your workflow from the section that corresponds to your host operating system.

In this section...
“Windows 64 Host Workflow” on page 25-10
“Linux Host Workflow” on page 25-12

Windows 64 Host Workflow

Target Machine	DPI Component to Generate	DPI-C Options Selection	Port and Build
Windows 32	ModelSim project	<ol style="list-style-type: none"> At the Toolchain prompt, select Mentor Graphics ModelSim/ QuestaSim (32-bit Windows). In the Code Generation pane, select Package code and artifacts. 	The package code option creates a zip file containing the files required to generate the ModelSim project on the Windows 32 platform. You need to build the libraries in the ModelSim HDL simulator on the target machine. See “Port ModelSim Project to Windows 32” on page 26-23.
	Generic DLL	<ol style="list-style-type: none"> At the Toolchain prompt, select Automatically locate an installed toolchain. In the Code Generation pane, select Package code and artifacts. 	The package code option creates a zip file containing the files required to generate the shared library on the Windows 32 platform. You need to build the libraries on the target machine. See “Port Generic DLL to Windows 32” on page 26-22.

Target Machine	DPI Component to Generate	DPI-C Options Selection	Port and Build
Linux	ModelSim project	<ol style="list-style-type: none"> 1. At the Toolchain prompt, select Mentor Graphics ModelSim/ QuestaSim (64-bit Linux). 2. In the Code Generation pane, select Package code and artifacts. 	The package code option creates a zip file containing the files required to generate the ModelSim project on the Linux machine. You need to build the libraries in the ModelSim HDL simulator on the target machine. See “Port ModelSim Project to Linux” on page 26-24.
	Incisive project	<ol style="list-style-type: none"> 1. At the Toolchain prompt, select Cadence Incisive (64-bit Linux). 2. In the Code Generation pane, select Package code and artifacts. 	The package code option creates a zip file containing the files required to generate the Incisive project on the Linux machine. You need to build the libraries in the Incisive HDL simulator on the target machine. See “Port Incisive Project to Linux” on page 26-24.
	Generic DLL	At the Toolchain prompt, select Automatically locate an installed toolchain . Selecting this toolchain generates the shared library.	See “Port Generic DLL to Linux” on page 26-23, but follow only the build instructions.
Host Machine (Windows 64)	ModelSim project	At the Toolchain prompt, select Mentor Graphics ModelSim/ QuestaSim (64-bit Windows) . During DPI-C generation, the software creates the work folder for the ModelSim project, which contains the DPI component.	If you want to use the component on a Windows 64 machine other than the host, copy the generated ModelSim project to the target machine.

Target Machine	DPI Component to Generate	DPI-C Options Selection	Port and Build
	Generic DLL	At the Toolchain prompt, select Automatically locate an installed toolchain . Selecting this toolchain generates the shared library.	If you want to use the component on a Windows 64 machine other than the host, copy the generated DLL to the target machine.

Linux Host Workflow

You cannot port a DPI component generated on a Linux machine to any other operating system.

DPI Component to Generate	DPI-C Options Selection	Build
ModelSim project	At the Toolchain prompt, select Mentor Graphics ModelSim/Questasim (64-bit Linux) .	Build the component from within ModelSim. If you want to use the component on a Linux machine other than the host, copy the generated ModelSim project to the target machine.
Incisive project	At the Toolchain prompt, select Cadence Incisive (64-bit Linux) .	Build the component from within ModelSim. If you want to use the component on a Linux machine other than the host, copy the generated Incisive project to the target machine.
Generic DLL	At the Toolchain prompt, select Automatically locate an installed toolchain . Selecting this toolchain generates the shared library.	See “Port Generic DLL to Linux” on page 26-23, but follow only the build instructions

SystemVerilog DPI Component Generation for Simulink

- “Generate SystemVerilog DPI Component” on page 26-2
- “Customize Generated SystemVerilog Code” on page 26-6
- “Verify Generated Component Against Simulink Data” on page 26-10
- “Use Generated DPI-C Functions in SystemVerilog” on page 26-11
- “SystemVerilog DPI Component Test Point Access” on page 26-13
- “Tune Gain Parameter During Simulation” on page 26-16
- “Port and Build Shared Libraries and Simulator Projects” on page 26-22

Generate SystemVerilog DPI Component

In this section...

“Select Options for Code Generation” on page 26-2

“Generate SystemVerilog DPI Component” on page 26-4

Select Options for Code Generation

- “Step 1. Select Target” on page 26-2
- “Step 2. Select Toolchain” on page 26-2
- “Step 3. Enable Test Point Access (Optional)” on page 26-3
- “Step 4. Select Option to Generate Test Bench (Optional)” on page 26-3

Step 1. Select Target

- 1 Open your model, and select **Simulation > Model Configuration Parameters**.
- 2 Select the Code Generation pane.
- 3 At **System target file**, under **Target Selection**, click **Browse**. Select `systemverilog_dpi_grt.tlc` from the list.
 - If you have a license for Embedded Coder, you can select target `systemverilog_dpi_ert.tlc`. This target allows you to access its additional code generation options using the Model Configuration Parameters dialog box.

Step 2. Select Toolchain

At **Toolchain**, under **Build process**, select the toolchain you want to use from the list. For guidance on selecting a toolchain, see “Determine Workflow for DPI-C Target” on page 25-10.

You can optionally add additional flags for compilation. Under **Build Configuration**, select **Specify**. Click **Show Settings** to display additional flags already selected.

Step 3. Enable Test Point Access (Optional)

Execute this step if you designated internal signals in your model as test points and want to access them in the generated DPI component.

- 1 In the left pane, select **Code Generation > Interface**.
- 2 For **Interface**, select **C API** and in **Generate API for**, ensure the **signals** check box is selected.

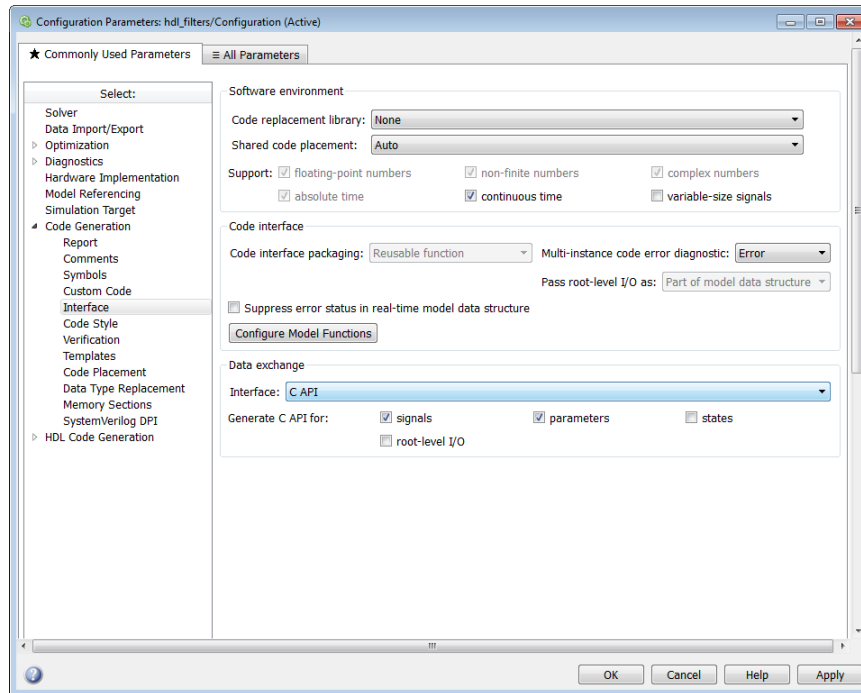

- 3 Select **Code Generation > SystemVerilog DPI**.
- 4 For **Generate access function to test point**, select **One function per Test Point** or **One function for all Test Points**.

See “SystemVerilog DPI Component Test Point Access” on page 26-13.

Step 4. Select Option to Generate Test Bench (Optional)

- 1 Select the **Code Generation > SystemVerilog DPI** pane.
- 2 Select **Generate test bench** if you want to generate a test bench. The test bench checks the generated component against data vectors from your Simulink subsystem.

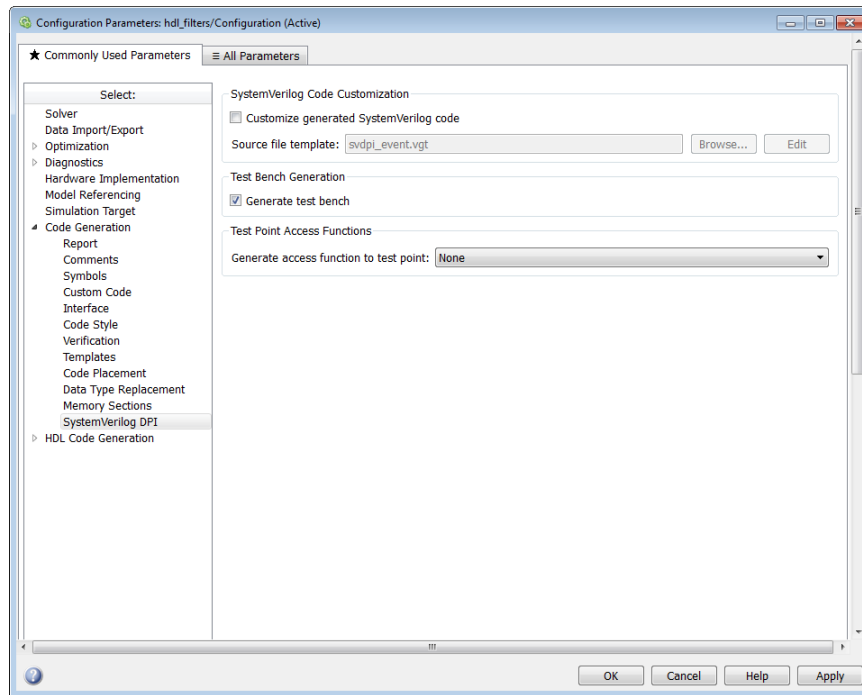

- 3 Click **OK** to accept these settings and to close the Configuration Parameters dialog box. Go to “Generate SystemVerilog DPI Component” on page 26-4.

Generate SystemVerilog DPI Component

- 1 In your model, right click the block containing the subsystem you want to generate the component from and set the subsystem as atomic.
 - a Click the subsystem.
 - b Select **Block Parameters (Subsystem)**.
 - c Select **Treat as atomic unit**.
- 2 Select **Code > C/C++ Code > Build Selected Subsystem**.
- 3 Click **Build**.

The SystemVerilog component is generated as *subsystem_build/subsystem_dpi.sv*, where *subsystem* is the name of the subsystem from which you generated the DPI component.

If you built the component for the host machine, you can now use the component. If you intend to port the component to another machine with a different operating system, see “Port and Build Shared Libraries and Simulator Projects” on page 26-22.

Customize Generated SystemVerilog Code

In this section...
“Set Up Model for Customized Code Generation” on page 26-6
“Generate Customized SystemVerilog DPI Component” on page 26-9

Set Up Model for Customized Code Generation

- 1 Open your model and select **Simulation > Model Configuration Parameters**.
- 2 Select the Code Generation pane.
- 3 At **System target file**, click **Browse** and select `systemverilog_dpi_grt.tlc`.
 - If you have a license for Embedded Coder, you can select target `systemverilog_dpi_ert.tlc`. This target allows you to access its additional code generation options (on the Code Generation pane in the Model Configuration Parameters dialog box).
- 4 At **Toolchain**, under **Build process**, select the toolchain you want to use from the list. See “Determine Workflow for DPI-C Target” on page 25-10 for guidance on selecting a toolchain.

You can optionally select flags for compilation. Under **Build Configuration**, select **Specify** from the drop-down list. Click **Show Settings** to display the current flags.

- 5 Expand Code Generation and select **SystemVerilog DPI**.
- 6 Select option **Customize generated SystemVerilog code**.
- 7 Specify the SystemVerilog template you want to use.

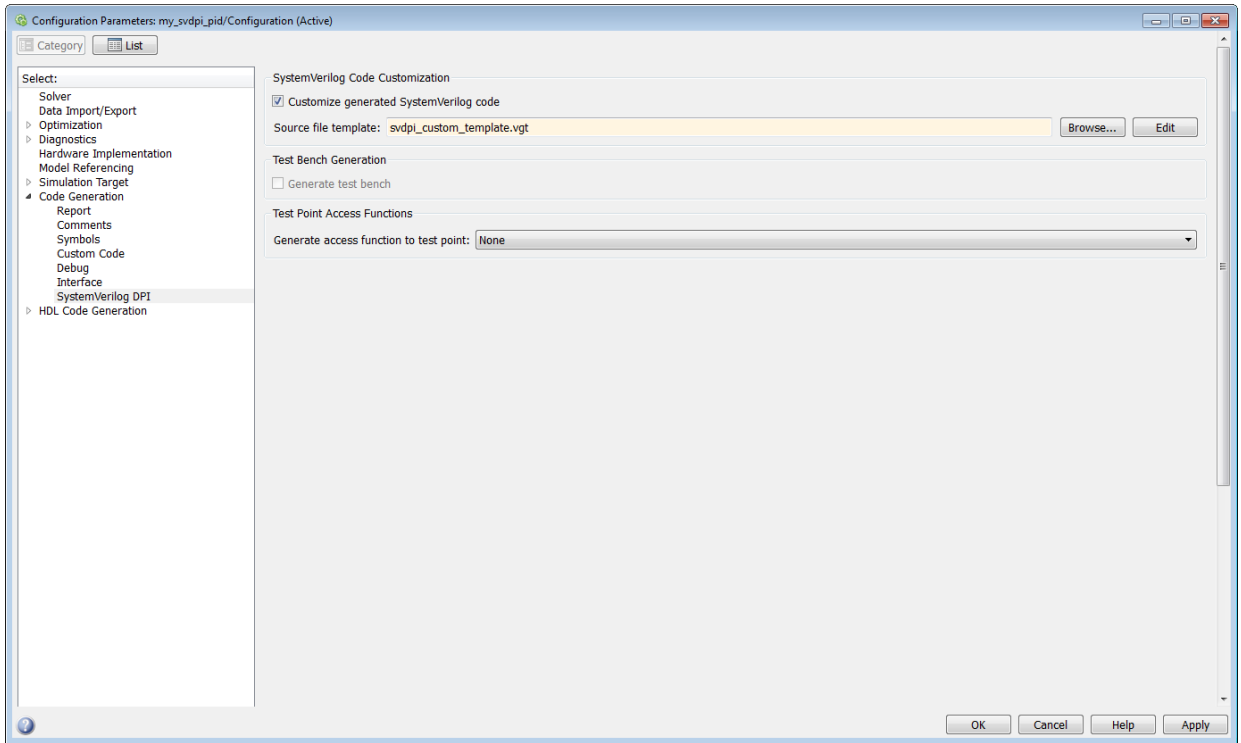

You can select **Edit** to see the contents of the template. The following example shows the content of the template file provided with HDL Verifier, `svdpi_grt_template.vgt`:

```

svdpi_ert_template.vgt x +
1 |#####
2 |**
3 |** Abstract:
4 |** This is the example SystemVerilog source code template.
5 |** With this template you are able to highly customize and
6 |** manipulate the appearance of the generated code. The template is
7 |** ideally suited for adding company information, including version
8 |** control tokens, adjusting the code's appearance, and so on.
9 |**
10 |** There is a list of optional tokens that can be used to comment the
11 |** generated code. These tokens can be used inside comment statements
12 |** anywhere throughout the template:
13 |**
14 |** %<FileName>, %<PortList>, %<ImportInitFunction>, %<ImportOutputFunction>,
15 |** %<ImportUpdateFunction>, %<CallInitFunction>, %<CallUpdateFunction>
16 |** %<CallOutputFunction>
17 |**
18 |** For more customization options, see the HDL Verifier User's Guide.
19 |**
20 |** Copyright 2013 The MathWorks, Inc.
21 |
22 |`timescale 1ns / 1ns
23 |
24 |module %<FileName>
25 | (
26 |     input clk,
27 |     input reset,
28 |     input clken_in,
29 |     output clken_out,
30 |     %<PortList>
31 | );
32 |
33 |     %<ImportInitFunction>
34 |     %<ImportOutputFunction>
35 |     %<ImportUpdateFunction>
36 |
37 |     always @(reset) begin
38 |         %<CallInitFunction>
39 |     end
40 |
41 |     always @(posedge clk) begin
42 |         %<CallUpdateFunction>
43 |     end
44 |
45 |     always @(clken_in) begin
46 |         %<CallOutputFunction>
47 |     end
48 |
49 |     assign #1 clken_out = clken_in;
50 |
51 | endmodule
52 |

```

For more about the customized template, see “Customization” on page 25-7.

- 8 Click **OK** to accept these options and close the Configuration Parameters dialog box. Next, go to “Generate Customized SystemVerilog DPI Component” on page 26-9.

Generate Customized SystemVerilog DPI Component

- 1 In your model, generate C code for subsystem.

You can generate C code from the command line by using the MATLAB command `rtwbuild`.

- 2 If you built the component for the host machine, you can now use the component. If you intend to port the component to another machine with a different operating system, see “Port and Build Shared Libraries and Simulator Projects” on page 26-22.

Verify Generated Component Against Simulink Data

For Mentor Graphics ModelSim and QuestaSim

- 1 Start ModelSim or QuestaSim in GUI mode.
- 2 Change your current folder to the dpi_tb folder under the code generation folder in your HDL simulator installation.
- 3 Enter the following command to start your simulation:

```
do run_tb_mq.do
```

- 4 When the simulation finishes, it displays the following message in your console:

```
*****TEST COMPLETED (PASSED)*****
```

For the Cadence Incisive Simulator

- 1 Start your terminal shell.
- 2 Change the current folder to "dpi_tb" under the code generation folder.
- 3 Enter the following command in your shell.

```
sh run_tb_ncsim.sh
```

- 4 When the simulation finishes, it displays the following message in your console:

```
*****TEST COMPLETED (PASSED)*****
```

Use Generated DPI-C Functions in SystemVerilog

To use the generated DPI component in a SystemVerilog environment, first import the generated functions with “DPI” declarations within your SystemVerilog module. Then, call and schedule the generated functions. When you compile the SystemVerilog code that contains the imported generated functions, use a DPI-aware SystemVerilog compiler and specify the component file names along with the SystemVerilog code.

The following example demonstrates adding the generated DPI component for the `DPI_blk` block to a SystemVerilog module.

- 1 Import the generated functions:

```
import "DPI-C" function void DPI_blk1_initialize();
import "DPI-C" function void DPI_blk1_ouptut(output real blk1_Y_Out1);
import "DPI-C" function void DPI_blk1_update(input real blk1_U_On1);
```

- 2 Call the `Initialize` function.

```
DPI_blk1_initialize();
```

- 3 Schedule the output and update function calls:

```
DPI_blk1_output( blk1_Y_Out1);
DPI_blk1_update( blk1_U_In1);
```

Example

```
import "DPI-C" function void DPI_blk1_initialize();
import "DPI-C" function void DPI_blk1_ouptut(output real blk1_Y_Out1);
import "DPI-C" function void DPI_blk1_update(input real blk1_U_On1);
```

```
module test_twoblock_tb;

    initial begin
        DPI_blk1_initialization();
    end

    always@(posedge clk) begin
        #1
        DPI_blk1_output(blk1_Y_Out1);
        DPI_blk1_update(blk1_U_In1);
    end
end
```

```
always@(posedge clk)
begin
    blk1_U_In1 = blk1_U_In1 + 1.0;
end
```

SystemVerilog DPI Component Test Point Access

You can designate internal signals in your model as test points and configure the SystemVerilog DPI generator to create one or more access functions. You can also enable logging on test points. Then you can use the generated test bench to automatically compare Simulink data with values observed while running the SystemVerilog component.

In this section...

“Step 1. Choose Internal Signals” on page 26-13

“Step 2. Add Test Points” on page 26-13

“Step 3. Enable Component Interface” on page 26-14

“Step 4. Configure Access Function” on page 26-15

Step 1. Choose Internal Signals

Choose an internal signal in your model, following these guidelines:

- Enable the test point at the source of the signal. If the test point is on a connecting signal, such as between subsystems, the signal might be optimized out of the generated code.
- Select a signal that is not an input or output of your component. If you select an I/O signal, the generator does not provide an access function. Such an access function is redundant because you already have visibility of the I/O signals.
- Complex signals are not supported.
- Virtual signals and buses are not supported.
- Continuous, asynchronous, and triggered sample times are not supported.
- Multirate designs are not supported for signal logging. You can add a test point, and generate an access function. However, the test bench is single rate and cannot perform a comparison against logged data at different rates.

Step 2. Add Test Points

- 1 In your model, right-click the signal and select **Properties**.

- 2 Select the **Test point** check box.
- 3 Give the test point a unique name in the **Signal name** box.
- 4 Optionally, select **Log signal data**. This check box enables the generated test bench to compare logged data from the model against values observed while running the generated component. The test bench uses the generated access functions to fetch the signal values during the simulation.

For more details on test points and logging in Simulink, see “Test Points”.

Step 3. Enable Component Interface

- 1 From your model, select **Simulation > Model Configuration Parameters**.
- 2 From the left pane, select **Code Generation > Interface**.
- 3 For **Interface**, select **C API**. In **Generate API for**, ensure the **signals** check box is selected. The other check boxes do not affect the DPI component or test bench.

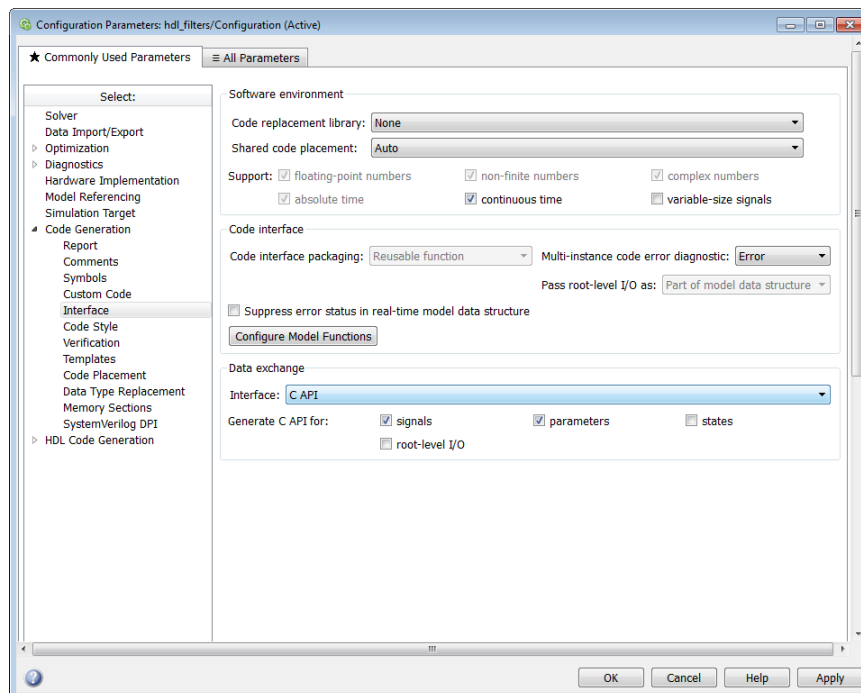

Step 4. Configure Access Function

- 1 In **Model Configuration Parameters**, in the left pane, select **Code Generation > SystemVerilog DPI**.
- 2 For **Generate access function to test point**, select **One function per Test Point** or **One function for all Test Points**.

If you select **One function for all Test Points**, a single function returns values for all test points.

```
DPI_TestPointAccessFcn(inputchandle objhandle, input real Name1, inout real Name2);
```

If you select **One function per Test Point**, each signal has a separate access function.

```
DPI_Name_TestPoint(inputchandle objhandle, inout real Name);
```

If you select **None**, the tool does not generate access functions.

Related Examples

- “Getting Started with SystemVerilog DPI Component Generation”

Tune Gain Parameter During Simulation

In this section...

- “Step 1. Create a Simple Gain Model” on page 26-16
- “Step 2. Create Data Object for Gain Parameter” on page 26-16
- “Step 3. Generate SystemVerilog DPI Component” on page 26-19
- “Step 4. Add Parameter Tuning Code to SystemVerilog File” on page 26-20
- “Step 5. Run Simulation with Parameter Change” on page 26-21

Step 1. Create a Simple Gain Model

If you would like to perform the example steps yourself, first create an example model.

The example model has a single gain block with a gain parameter that is tuned during simulation.



- 1 Open the Simulink Block Library and click Commonly Used Blocks.
- 2 Add an Inport block.
- 3 Add a Gain block. Double-click to open the block mask and change the value in the **Gain** parameter to **gain**.
- 4 Add an Outport block.
- 5 Connect all blocks as shown in the preceding diagram.

Step 2. Create Data Object for Gain Parameter

- 1 Create a data object for the gain parameter:

At the MATLAB command prompt, type:

```
gain = Simulink.Parameter
```

2 Next, type:

```
open('gain')
```

This command opens the property dialog box for the parameter object.

3

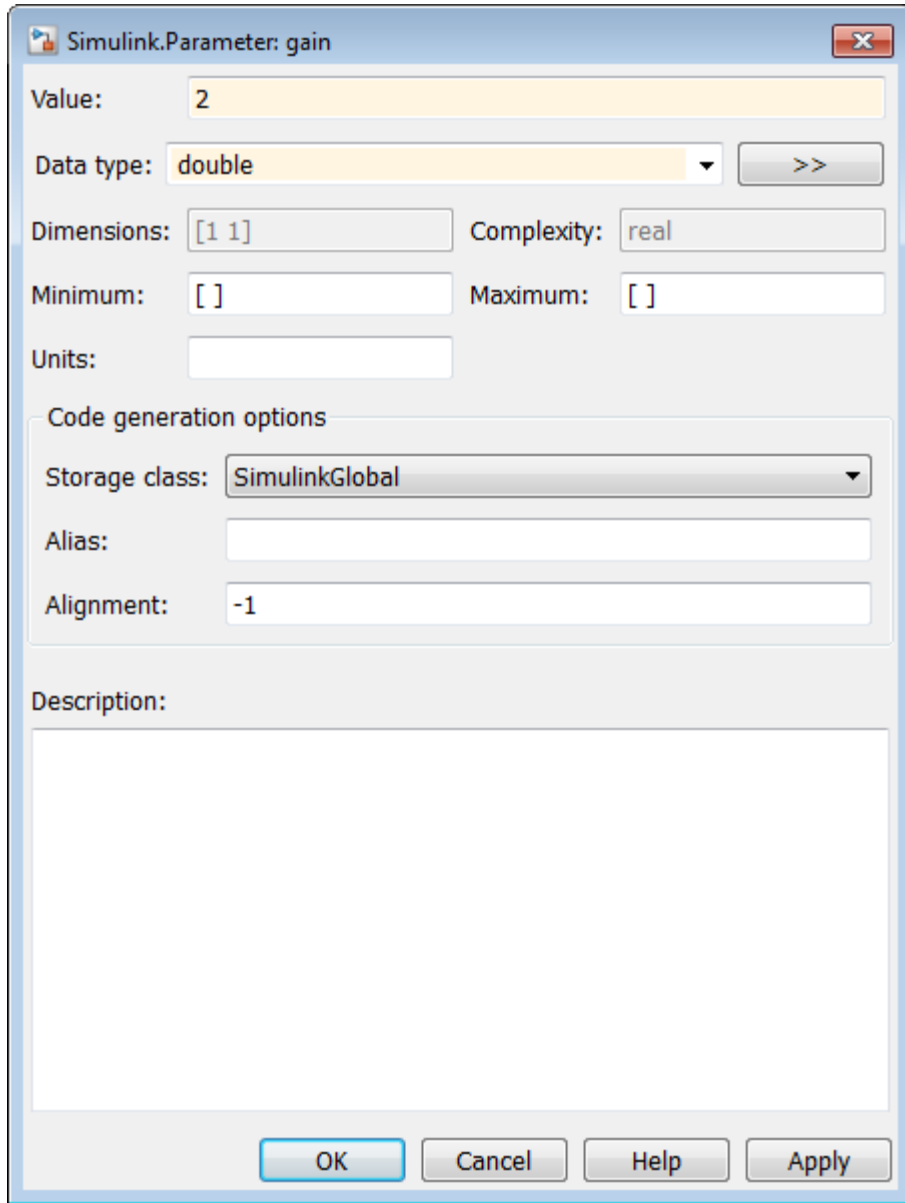

Enter or select the following values:

- **Value:** 2
- **Data type:** double
- **Storage class:** SimulinkGlobal

4 Click **OK**.

For more information about using parameter objects for code generation, see “Control Parameter Representation and Declare Tunable Parameters in the Generated Code” in the Simulink Coder documentation.

Step 3. Generate SystemVerilog DPI Component

- 1 With the gain model open, select **Simulation > Model Configuration Parameters**.
- 2 Click Code Generation.
- 3 At **System target file**, click **Browse** and select `systemverilog_dpi_grt.tlc`.
 - If you have a license for Embedded Coder, you can select target `systemverilog_dpi_ert.tlc`. This target allows you to access its additional code generation options (on the Code Generation pane in the Model Configuration Parameters dialog box).
- 4 At **Toolchain**, under **Build process**, select the toolchain you want to use from the list. See “Determine Workflow for DPI-C Target” on page 25-10 for guidance on selecting a toolchain.

You can optionally select flags for compilation. Under **Build Configuration**, select **Specify** from the drop-down list. Click **Show Settings** to display the current flags.

- 5 In the Code Generation navigation pane, click **SystemVerilog DPI**.
- 6 Leave both **Generate test bench** and **Customize generated SystemVerilog code** cleared (because this example modifies the generated SystemVerilog code, any test bench generated at the same time does not have the correct results).
- 7 Click **OK** to accept these settings and to close the Configuration Parameters dialog box.
- 8 In the example model, right click the gain and delay blocks and select **Create Subsystem from Selection**. For this example, rename the subsystem `dut`.

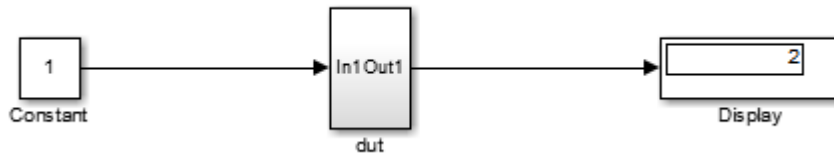

- 9 Right click the subsystem and select **C/C++ Code > Build this subsystem**.
- 10 In the Build code for subsystem dialog box, click **Build**.

The SystemVerilog component is generated as `dut_build/dut_dpi.sv` in your current working folder.

Step 4. Add Parameter Tuning Code to SystemVerilog File

- 1 Open the file `dut_build/dut_dpi.sv` and examine the generated code.
- 2 In this example, after you call the `initialize` function, call the `DPI_dut_setparam_gain` function with the new parameter value. For example, here the gain is changed to 6:

```
DPI_dut_setparam_gain(objhandle, 6);
```

- 3 If the asynchronous reset signal is high (goes from 0 to 1), call `Initialize` again.

```
if(reset == 1'b1) begin
    objhandle = DPI_dut_initialize(objhandle);
    DPI_dut_setparam_gain(objhandle, 6);
end
```

- 4 The SystemVerilog code should now look like this example:

```
// File: dut_build\dut_dpi.sv
// Created: 2015-01-21 13:58:40
// Generated by MATLAB 8.5 and HDL Verifier 4.6

`timescale 1ns / 1ns

module dut_dpi(
    input clk,
    input clk_enable,
    input reset,
    input real dut_U_In1,
    output real dut_Y_Out1
);

   chandle objhandle=null;
```

```
// Declare imported C functions
import "DPI-C" function chandle DPI_dut_initialize(chandle existhandle);
import "DPI-C" function void DPI_dut_output(input chandle objhandle, input real dut_U_In1, inout real dut_Y_Out1);
import "DPI-C" function void DPI_dut_update(input chandle objhandle, input real dut_U_In1);
import "DPI-C" function void DPI_dut_terminate(input chandle objhandle);
import "DPI-C" function void DPI_dut_setparam_gain(input chandle objhandle, input real dut_P_gain);

initial begin
    objhandle = DPI_dut_initialize(objhandle);
    DPI_dut_setparam_gain(objhandle, 6);
end

always @(posedge clk or posedge reset) begin
    if(reset == 1'b1) begin
        objhandle = DPI_dut_initialize(objhandle);
        DPI_dut_setparam_gain(objhandle, 6);
    end
    else if(clk_enable) begin
        DPI_dut_output(objhandle, dut_U_In1, dut_Y_Out1);
        DPI_dut_update(objhandle, dut_U_In1);
    end
end
endmodule
```

Step 5. Run Simulation with Parameter Change

To run your simulation, build the shared library and export the component, as explained in the following topics:

- Rebuild shared library as described in “Port and Build Shared Libraries and Simulator Projects” on page 26-22.
- “Use Generated DPI-C Functions in SystemVerilog” on page 26-11

Port and Build Shared Libraries and Simulator Projects

If your target and host are not the same, you must port and build the shared libraries or HDL simulator projects manually. For guidance in choosing a build toolchain for cross-platform generated DPI-C use, see “Determine Workflow for DPI-C Target” on page 25-10.

Note: When you build the shared libraries, make sure that you use the correct bit version of the tools. For example, if you are using 64-bit ModelSim on Windows, use the 64-bit version of Visual Studio to build the shared libraries.

In this section...

“Port Generic DLL to Windows 32” on page 26-22

“Port ModelSim Project to Windows 32” on page 26-23

“Port Generic DLL to Linux” on page 26-23

“Port ModelSim Project to Linux” on page 26-24

“Port Incisive Project to Linux” on page 26-24

Port Generic DLL to Windows 32

After you generate the DPI component:

- 1 Copy the zip file from the host machine (in the top-level folder, where the model is located) to the Windows 32 target machine.

If you also want to port the test bench, copy the contents of the `dpi_tb` folder too.
- 2 Unzip the file into any folder of your choice. Flatten the folder structure when unzipping the files. If you do not flatten the folder structure, then you need to modify the `INCLUDE` paths in the makefile.
- 3 If you are using 64-bit ModelSim, start **Visual Studio x64 Win64 Command Prompt**. If you are using 32-bit ModelSim, start **Visual Studio Command Prompt**. You can find these applications on the Visual Studio installation menu.
- 4 At the **Visual Studio Command Prompt**, change the folder to `subsystem_build` under the current folder, where `subsystem` is the name of the subsystem from which you generated the DPI component.

- 5 Enter the following command:

```
nmake -f makefile_dpi_vc.mk
```

The shared libraries are now built and you can use the generated component on the target machine, or run the test bench.

Port ModelSim Project to Windows 32

- 1 Copy the zip file from the host machine (in the top-level folder, where the model is located) to the Windows 32 target machine.

If you also want to port the test bench, copy the contents of the `dpi_tb` folder too.

- 2 Unzip the file into any folder of your choice. Flatten the folder structure when unzipping the files. If you do not flatten the folder structure, then you need to modify the `INCLUDE` paths in the makefile.
- 3 For a 64-bit Windows host, verify that you have installed the `gcc_ver_mingw64` compiler. This compiler is available when you install ModelSim. Install the compiler before building the component. You can check to see if the compiler is already installed by opening the ModelSim installation folder.
- 4 Start the ModelSim HDL simulator.
- 5 From the ModelSim prompt, enter:

```
do DUT_name.do
```

DUT_name is the name of the component you generated.

You can now integrate the project with a larger design in ModelSim, or run the test bench.

Port Generic DLL to Linux

- 1 Copy the following files to the Linux target machine:
 - Zip file (in the top-level folder, where the model is located)
 - Makefile (where the source files are located)
 - The contents of the `dpi_tb` folder if you also want to port the test bench.
- 2 Start a terminal shell.

- 3 Unzip the file into any folder of your choice by entering the following:

```
unzip -j zipfile.zip
```

The `-j` argument flattens the folder structure when the files are unzipped.

- 4 Change the folder to the folder where you unzipped the generated code.
- 5 Enter the following command:

```
make -f makefile_dpi_gcc.mk
```

After the shared library build completes, you see the *subsystem.so* file that the command generated. *subsystem* is the name of the subsystem from which you generated the DPI component.

The shared libraries are now built and you can use the generated component on the target machine, or run the test bench.

Port ModelSim Project to Linux

- 1 Copy the zip file from the host machine (in the top-level folder, where the model is located) to the Linux target machine.

If you also want to port the test bench, copy the contents of the *dpi_tb* folder too.

- 2 Unzip the file into any folder of your choice.
- 3 Start the ModelSim HDL simulator.
- 4 At the ModelSim prompt, enter:

```
do subsystem.do
```

Where *subsystem* is the name of the subsystem from which you generated the DPI component.

You can now integrate the project with a larger design in ModelSim, or run the test bench.

Port Incisive Project to Linux

- 1 Copy the zip file from the host machine (in the top-level folder, where the model is located) to the Linux target machine.

if you also want to port the test bench, copy the contents of the `dpi_tb` folder too.

- 2 Unzip the file into any folder of your choice.
- 3 Open any shell with Incisive on the path, and enter the following command:

```
sh subsystem.sh
```

subsystem is the name of the subsystem from which you generated the DPI component.

You can now integrate the project with a larger design in Incisive, or run the test bench.

Related Examples

- “Use Generated DPI-C Functions in SystemVerilog” on page 26-11
- “Verify Generated Component Against Simulink Data” on page 26-10

Context-Sensitive Help for Generated SystemVerilog DPI Component

SystemVerilog DPI Pane

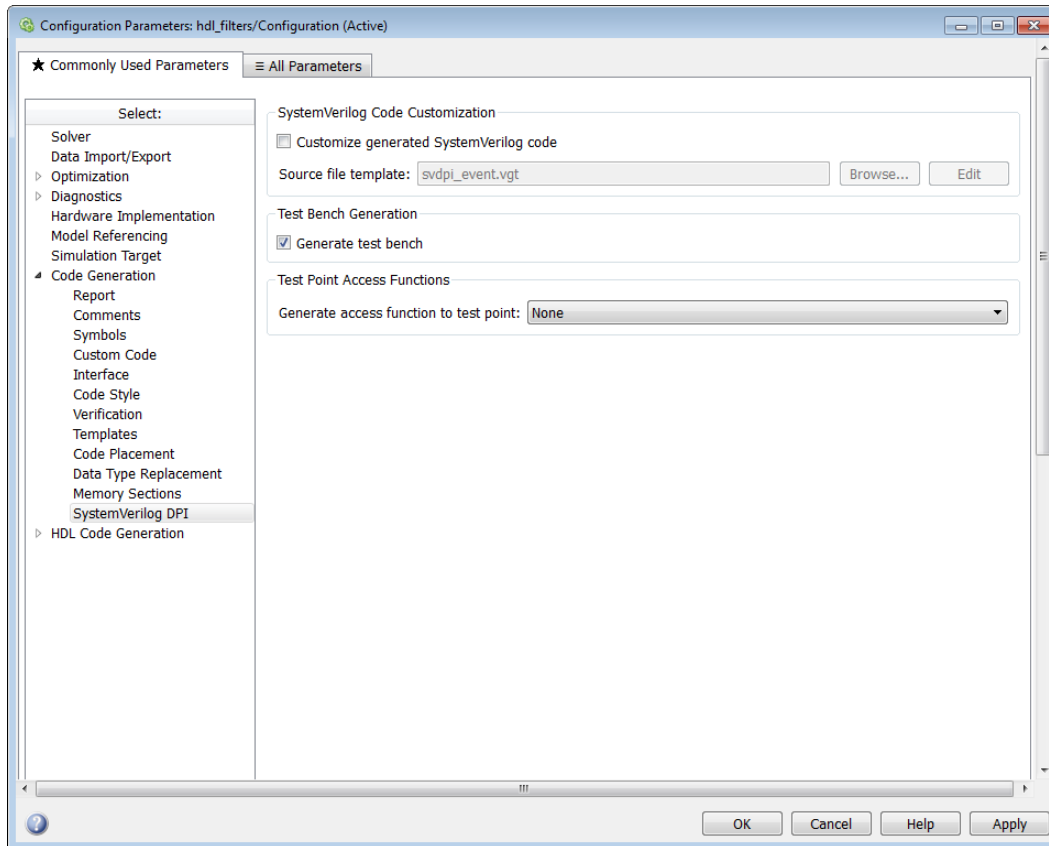

In this section...

“SystemVerilog DPI Overview” on page 27-3

“Customize SystemVerilog generated code” on page 27-4

“Source file template:” on page 27-5

“Generate test bench” on page 27-6

“Test point access” on page 27-7

SystemVerilog DPI Overview

Specify options for exporting a Simulink algorithm (model or subsystem) with a DPI interface for Verilog or SystemVerilog Simulation. You can wrap generated C code with a DPI wrapper that communicates with a SystemVerilog thin interface function in a SystemVerilog simulation.

This feature is available in the Model Configuration Parameters dialog. You must have an Embedded Coder license to use this feature.

Customize SystemVerilog generated code

Indicate that you want to customize the generated SystemVerilog code.

Settings

Default: Off



On

Customize generated SystemVerilog code



Off

Do not customize generated SystemVerilog code

Dependencies

You must enter a template file in **Source file template:** if you want the generator to include customized code.

Source file template:

Specify the file name and location of the template you want to use for customizing the generated SystemVerilog code. You may use the template supplied by HDL Verifier (`svdpi_ert_template.vgt`) or you may specify your own template file with the following conditions:

- The file must be on MATLAB path and be searchable.
- The file must have a `.vgt` extension.

Generate test bench

Indicate that you want to generate a test bench for the DPI component.

Settings

Default: Off



On

Create a test bench for the generated DPI component



Off

Do not create a test bench for the generated DPI component

Test point access

Select the type of test point access functions to generate in the SystemVerilog DPI component.

Settings

Default: None

None

The tool does not generate test point access functions.

One function per Test Point

The component includes a separate access function for each signal.

```
DPI_Name_TestPoint(input chandle objhandle,inout real Name);
```

One function for all Test Points

The component includes a single access function that returns values for all test points.

```
DPI_TestPointAccessFcn(input chandle objhandle,input real Name1,inout real Name2);
```

